

SINGER
27W1 & 27W20

PRICE LIST
OF
PARTS
AND
COMBINATIONS
FOR
27 w 1 and 27 w 20
SEWING MACHINES

THE SINGER MANUFACTURING CO.

BRIDGEPORT, CONN.

INSTRUCTIONS FOR ORDERING

In ordering from this list, use **ONLY** the **PART** number in the **FIRST** column.

The number stamped on Sewing Machine parts is in every case the number of the single part only.

Every combination of parts sent out as such has its specific number, which, although not stamped on the parts, must be used when ordering the combination.

Each number always indicates the **SAME PART** in whatever list it appears, or for whatever Machine.

The letters after some of the numbers indicate the style of finish only, as follows:

- A. Hardened, Polished and Plated.
- B. Polished and Plated.
- C. Hardened only.
- D. Polished only.
- E. Soft, not polished.

These letters **MUST BE USED** when they appear in the list and **AFTER** the number, as in the list.

In this series

200001 to 201500 are Screw Numbers.

201501 to 201800 are Nut Numbers.

201801 to 202000 are Roller Numbers.

202001 and upward are numbers of Machine Parts.

The figures in the second column refer only to the plate in which the illustration of the **PART** is shown and are **NOT TO BE USED** in ordering.

Two or more numbers over a cut indicate that the difference between such parts is not visible in an illustration.

Parts marked with an asterisk (*) are furnished only when repairs are made at factory.

From the library of: Diamond Needle Co. P

INDEX

| | Page |
|-------------------------|------|
| Machine No. 27 w 1..... | 1 |
| " " 27 w 20..... | 11 |

COMBINATIONS

| New No. | Formerly No. | Page |
|-------------|--------------|------|
| 226500..... | 3..... | 21 |
| 226508..... | 4..... | 23 |
| 226516..... | 7..... | 24 |
| 226523..... | 8..... | 26 |
| 226369..... | 9..... | 28 |
| 226528..... | 11..... | 29 |
| 226536..... | 13..... | 31 |
| 226377..... | 17..... | 33 |
| 226547..... | 20..... | 34 |
| 226386..... | 25..... | 36 |
| 226392..... | 26..... | 38 |
| 226551..... | 28..... | 39 |
| 226569..... | 33..... | 43 |
| 226616..... | 35..... | 46 |
| 226657..... | 37..... | 49 |
| 226578..... | 40..... | 51 |
| 226362..... | 41..... | 53 |
| 226587..... | 42..... | 56 |
| 226590..... | 43..... | 59 |
| 226363..... | 44..... | 62 |
| 226596..... | 45..... | 65 |
| 226599..... | 47..... | 69 |
| 226603..... | 48..... | 72 |
| 226411..... | 50..... | 76 |
| 226430..... | 51..... | 79 |
| 226620..... | 55..... | 83 |
| 226623..... | 57..... | 86 |
| 226631..... | 59..... | 89 |
| 226443..... | 60..... | 92 |
| 226632..... | 62..... | 95 |
| 226636..... | 63..... | 98 |
| 226646..... | 64..... | 100 |

COMBINATIONS

| New No. | Formerly No. | Page |
|-------------|--------------|------|
| 226784..... | 65..... | 102 |
| 226655..... | 66..... | 105 |
| 226790..... | 67..... | 107 |
| 226461..... | 68..... | 109 |
| 226661..... | 69..... | 111 |
| 226670..... | 70..... | 114 |
| 226677..... | 71..... | 117 |
| 226682..... | 72..... | 119 |
| 226692..... | 73..... | 122 |
| 226698..... | 74..... | 124 |
| 226702..... | 75..... | 127 |
| 226709..... | 76..... | 129 |
| 226478..... | 77..... | 131 |
| 226714..... | 78..... | 134 |
| 226719..... | 79..... | 137 |
| 226725..... | 80..... | 140 |
| 226734..... | 81..... | 142 |
| 226737..... | 82..... | 144 |
| 226746..... | 83..... | 147 |
| 226751..... | 84..... | 149 |
| 226493..... | 87..... | 151 |
| 226793..... | 94..... | 153 |
| 226756..... | 95..... | 156 |
| 226765..... | 96..... | 159 |
| 226772..... | 98..... | 162 |
| 226780..... | 99..... | 165 |
| 226788..... | 100..... | 167 |
| 226789..... | 101..... | 169 |

| No. | Plate | Name | Each |
|--|-------|---|------|
| 204802 | --- | Arm Shaft Bushing (front) with 202126 and 202241 | 35 |
| 202244 | 10279 | Arm Shaft Bushing (front) Oil Packing (wick) | 02 |
| 200502B | 11303 | Arm Shaft Bushing (front) Oil Packing Thumb Screw..... | 25 |
| 202126 | 10434 | Arm Shaft Bushing (front) Position Pin | 01 |
| 200342 | 11303 | Arm Shaft Bushing (front) Set Screw... | 03 |
| 204804 | 11301 | Arm Shaft Connection with 204166, 204167 and four 200054r..... | 80 |
| *204166 | --- | Arm Shaft Connection Cap (lower).... | --- |
| *204167 | --- | Arm Shaft Connection Cap (upper).... | --- |
| 200054E | 10434 | Arm Shaft Connection Screw..... | 03 |
| 204805 | 11301 | Balance Wheel (power) 5 $\frac{1}{2}$ in. diam. (belt groove 3 in. diam.) with 200328c and 200335c..... | 1 00 |
| Note: No. 204805 is sent with this Machine unless another Balance Wheel is specified on order. | | | |
| 204169B | --- | Balance Wheel 5 $\frac{5}{8}$ in. diam. with 200328c and 200335c for 204170..... | 1 00 |
| 200062 | 10434 | Balance Wheel Adjusting Screw..... | 07 |
| 200328c | 10434 | Balance Wheel Position Screw..... | 04 |
| 204170 | --- | Balance Wheel Pulley (loose) 3 in. diam. | 20 |
| 202015 | 10434 | Balance Wheel Pulley Spring Washer... | 05 |
| 200335c | 10434 | Balance Wheel Set Screw..... | 01 |
| 201569B | 10434 | Balance Wheel Thumb Nut with 200609c | 35 |
| 200609c | 10434 | Balance Wheel Thumb Nut Stop Screw... | 03 |
| 202016 | 10434 | Balance Wheel Thumb Nut Stop Screw Washer | 05 |
| 204172 | --- | Balance Wheel (belt groove 3 in. diam.) complete, Nos. 201569B, 202015, 202016, 204169B and 204170..... | 1 70 |
| *203328 | --- | Bed with 202064..... | 5 00 |
| 202258 | 11003 | Bed Hinge Connection..... | 08 |
| 200570E | 10434 | Bed Hinge Connection Screw..... | 05 |
| 202259 | 11003 | Bed Hinge Plate with two $\frac{3}{8}$ in. No. 13 Wood Screws | 08 |
| 203206 | 11003 | Bed Slide (back)..... | 30 |
| 203207 | 11003 | Bed Slide (front)..... | 25 |
| 203208 | 11228 | Bobbin (formerly "4")..... | 05 |
| 203210 | 11228 | Bobbin Case Base with 202056, 203211 to 203213 and 203216..... | 55 |

| No. | Plate | Name | Each |
|---------|-------|---|------|
| *203211 | --- | Bobbin Case Base Latch..... | 05 |
| *202056 | --- | Bobbin Case Base Latch Pin..... | 01 |
| *203212 | --- | Bobbin Case Base Latch Plunger..... | 02 |
| *203213 | --- | Bobbin Case Base Latch Spring..... | 01 |
| 203209 | 11228 | Bobbin Case Cap with 200593, 203214, 203215 and two 200594c..... | 25 |
| 203214 | 11228 | Bobbin Case Tension Spring (formerly "F") | 05 |
| 200593 | 11228 | Bobbin Case Tension Spring Regulating Screw | 02 |
| 200594c | 11228 | Bobbin Case Tension Spring Screw..... | 02 |
| 203215 | 11228 | Bobbin Case Thread Guide..... | 03 |
| 200594c | 11228 | Bobbin Case Thread Guide Screw..... | 02 |
| 203216 | 11228 | Bobbin Case Washer (cloth) Per 100.... | 25 |
| 203217 | 11228 | Bobbin Case complete, Nos. 203209 and 203210 | 80 |
| 204184 | 11301 | Face Plate with 200366c, 200368c, 202090, 204185, 204281 and two 200385c..... | 75 |
| 200053c | 10435 | Face Plate Screw..... | 04 |
| 204185 | 10435 | Face Plate Thread Guide..... | 03 |
| 200385c | 10435 | Face Plate Thread Guide Set Screw.... | 02 |
| 204186 | 11301 | Face Plate complete, Nos. 200435, 200309c, 200319c, 200577, 204059, 204184, 204267, 204272 and 204277 to 204280.... | 40 |
| 203303 | 11032 | Feed Bar with 204189..... | 40 |
| 200244c | 10435 | Feed Bar Hinge Screw..... | 12 |
| 201525E | 10435 | Feed Bar Hinge Screw Nut..... | 03 |
| 204188 | 10435 | Feed Bar Spring..... | 03 |
| 204189 | 10435 | Feed Bar Spring Hook..... | 01 |
| 211002 | 11350 | Feed Dog for 211001..... | 60 |
| 200406E | 10435 | Feed Dog Screw..... | 02 |
| 203233 | 11005 | Feed Driving Cam (formerly "V-H") with 200378c and 200437c..... | 50 |
| 204192 | 10436 | Feed Driving Cam Fork-lever..... | 70 |
| 204193 | 11003 | Feed Driving Cam Fork-lever Connection with 200668c and 201525E..... | 25 |
| 204194 | 10438 | Feed Driving Cam Fork-lever Connection Clamp with 200031c..... | 45 |
| 200031c | 10438 | Feed Driving Cam Fork-lever Connection Clamp Pinch Screw..... | 01 |
| 200668c | 10438 | Feed Driving Cam Fork-lever Connection Clamp Screw Stud..... | 06 |
| 204525E | 10435 | Feed Driving Cam Fork-lever Connection Clamp Screw Stud Nut..... | 03 |
| 200002E | 10436 | Feed Driving Cam Fork-lever Connection Hinge Screw..... | 07 |
| 201522 | 10436 | Feed Driving Cam Fork-lever Connection Hinge Screw Nut..... | 03 |

| No. | Plate | Name | Each |
|---------|-------|--|------|
| 204195 | 10436 | Feed Driving Cam Fork-lever Shaft..... | 15 |
| 204197 | 10436 | Feed Driving Cam Fork-lever Shaft Collar with 200143c..... | 15 |
| 200143c | 10436 | Feed Driving Cam Fork-lever Shaft Collar Set Screw..... | 03 |
| 204293 | 10436 | Feed Driving Cam Fork-lever Shaft Position Pin..... | 01 |
| 204196 | 10436 | Feed Driving Cam Fork-lever Shaft Sleeve (split)..... | 25 |
| 200043c | 10436 | Feed Driving Cam Fork-lever Shaft Sleeve Set Screw..... | 04 |
| 201524e | 10436 | Feed Driving Cam Fork-lever Shaft Sleeve Set Screw Nut..... | 03 |
| 204198 | 11304 | Feed Driving Cam Fork-lever complete, Nos. 204192, 204194, 204195 and 204293 | 1 30 |
| 200437c | 10436 | Feed Driving Cam Position Screw..... | 06 |
| 200378c | 10436 | Feed Driving Cam Set Screw..... | 02 |
| 204294 | 11301 | Feed Driving Rock Shaft..... | 35 |
| 202305c | 10436 | Feed Driving Rock Shaft Center..... | 06 |
| 200043c | 10436 | Feed Driving Rock Shaft Center Set Screw | 04 |
| 204200 | 10435 | Feed Driving Rock Shaft Crank with 204189 (on left side) and two 200383c.. | 35 |
| 200383c | 10435 | Feed Driving Rock Shaft Crank Set Screw | 02 |
| 200892 | 11005 | Feed Driving Rock Shaft Screw Center 200411 with 204512 (for repairs only)... | 10 |
| 204512 | --- | Feed Driving Rock Shaft Screw Center Nut (for repairs only)..... | 05 |
| 203235 | 11005 | Feed Lifting Cam (formerly "2") with 202126 | 75 |
| 204202 | 11003 | Feed Lifting Cam Fork with 200027c.... | 75 |
| 200027c | 11005 | Feed Lifting Cam Fork Pinch Screw.... | 04 |
| 202126 | 10434 | Feed Lifting Cam Position Pin..... | 01 |
| 200045c | 11005 | Feed Lifting Cam Screw..... | 03 |
| 203305 | 11301 | Feed Lifting Rock Shaft..... | 35 |
| 202305c | 10436 | Feed Lifting Rock Shaft Center..... | 06 |
| 200043c | 10436 | Feed Lifting Rock Shaft Center Set Screw | 04 |
| *202276 | --- | Feed Lifting Rock Shaft Slide Block.... | — |
| 203238 | 11005 | Feed Lifting Rock Shaft Slide Block 202276 with 200243e and 204534..... | 35 |
| 200243e | 11005 | Feed Lifting Rock Shaft Slide Block Hinge Screw..... | 08 |
| 204534 | 11005 | Feed Lifting Rock Shaft Slide Block Hinge Screw Nut..... | 03 |

| No. | Plate | Name | Each |
|---------|-------|---|------|
| 204206 | 11003 | Feed Regulating Handle..... | 10 |
| 204207 | 11003 | Feed Regulating Handle 204206 with 200098c, 202622, 204208 to 204210 and 204213 | 55 |
| 204208 | 10438 | Feed Regulating Handle Adjustable Stop | 05 |
| 200098c | 10438 | Feed Regulating Handle Adjustable Stop Screw | 03 |
| 204209 | 10438 | Feed Regulating Handle Position Pin... | 04 |
| 204210 | 10438 | Feed Regulating Handle Shaft..... | 20 |
| 204211 | 10438 | Feed Regulating Handle Shaft Crank with 200078c..... | 20 |
| 204212 | 10438 | Feed Regulating Handle Shaft Crank Link | 15 |
| 200271e | 10438 | Feed Regulating Handle Shaft Crank Link Hinge Screw (lower)..... | 05 |
| 200294e | 10438 | Feed Regulating Handle Shaft Crank Link Hinge Screw (upper)..... | 05 |
| 200078c | 10438 | Feed Regulating Handle Shaft Crank Set Screw | 03 |
| 204213 | 10438 | Feed Regulating Handle Shaft Sleeve (split) | 15 |
| 200362c | 10411 | Feed Regulating Handle Shaft Sleeve Set Screw | 03 |
| 202622 | 10438 | Feed Regulating Handle Shaft Sleeve Washer | 04 |
| 202036 | 10438 | Feed Regulating Handle Shaft Stop Pin | 04 |
| 204214 | --- | Feed Regulating Handle complete, Nos. 200294, 204207, 204211 and 204212.... | 95 |
| *203239 | --- | Hook (sewing)..... | — |
| 203240 | 11228 | Hook (sewing) 203239 with 200600, 200616 and 203254 | 2 20 |
| 203290 | 11228 | Hook and Bobbin Case complete, Nos. 203217 and 203240..... | 3 00 |
| 203241 | 11007 | Hook bevel Gear-Socket, 24 teeth, with 200555 | 85 |
| 200555 | 11007 | Hook bevel Gear-Socket Screw..... | 05 |
| 203242 | 11007 | Hook bevel Pinion, 24 teeth, with two 200383c | 1 00 |
| 200383c | 10435 | Hook bevel Pinion Set Screw..... | 02 |
| 203243 | 11304 | Hook Counter Shaft..... | 40 |
| 203244 | 11007 | Hook Counter Shaft Collar with two 200393c | 20 |
| 200393c | 11007 | Hook Counter Shaft Collar Set Screw.... | 02 |
| 203245 | 11007 | Hook Counter Shaft Driving Gear, 14 teeth, with 200362c and 200439c..... | 1 00 |
| 200439c | 10434 | Hook Counter Shaft Driving Gear Posi- tion Screw..... | 05 |
| 200362c | 10411 | Hook Counter Shaft Driving Gear Set Screw | 03 |

| No. | Plate | Name | Each |
|---------|-------|--|------|
| 203246 | 11007 | Hook Counter Shaft Gear, 22 teeth, with two 200383c..... | 75 |
| 200383c | 10435 | Hook Counter Shaft Gear Set Screw.... | 02 |
| 202299 | 10279 | Hook Counter Shaft Gear Oil Packing (wick) | 01 |
| 200840 | 11007 | Hook Counter Shaft Gear Oil Packing (wick) Stop Screw..... | 10 |
| 213624 | 11301 | Hook Driving Shaft..... | 1 75 |
| 203248 | 11304 | Hook Driving Shaft Bearing with 202126 and 202299..... | 20 |
| 202299 | 10279 | Hook Driving Shaft Bearing Oil Packing (wick) | 01 |
| 202126 | 10434 | Hook Driving Shaft Bearing Position Pin | 01 |
| 200516 | 10434 | Hook Driving Shaft Bearing Screw..... | 08 |
| 203249 | 11007 | Hook Driving Shaft Bushing (eccentric) | 25 |
| 200362c | 10441 | Hook Driving Shaft Bushing Set Screw | 03 |
| 203250 | 11007 | Hook Driving Shaft Collar with two 200393c | 20 |
| 200393c | 11007 | Hook Driving Shaft Collar Set Screw.... | 02 |
| 203251 | 11228 | Hook Gib..... | 40 |
| 200600 | 11228 | Hook Gib Hinge Screw..... | 02 |
| 200616 | 11228 | Hook Gib Screw..... | 02 |
| 203252 | 11227 | Hook Saddle with 202299..... | 1 00 |
| 202299 | 10279 | Hook Saddle Oil Packing (wick)..... | 01 |
| 200006E | 11007 | Hook Saddle Screw..... | 07 |
| 225585 | 11007 | Hook Saddle Screw Washer..... | 02 |
| 203254 | 11228 | Hook Washer with 203255..... | 20 |
| *203255 | - | Hook Washer Pin..... | 01 |
| 203253 | 11227 | Hook Saddle complete (No. 3 Outfit) Nos. 203241, 203252, 203254 and 203290 | 5 00 |
| 204827 | 11304 | Needle Bar (hollow) with 200125c, 200175e and 204250..... | 80 |
| 204248 | 11010 | Needle Bar Connecting Link..... | 35 |
| 200658c | 11010 | Needle Bar Connecting Link Hinge Screw Stud..... | 10 |
| 201519c | 11010 | Needle Bar Connecting Link Hinge Screw Stud Nut..... | 03 |
| 204249 | 11010 | Needle Bar Connecting Stud with 200072c | 40 |
| 200072c | 11010 | Needle Bar Connecting Stud Pinch Screw | 03 |
| 200504 | 11010 | Needle Bar Screw Bushing (lower)..... | 05 |
| 200503 | 11010 | Needle Bar Screw Bushing (upper)..... | 05 |
| 204250 | 11010 | Needle Bar Thread Guide..... | 03 |
| 200175E | 11005 | Needle Bar Thread Guide Set Screw.... | 02 |
| 200125c | 11303 | Needle Set Screw | 02 |
| 204251 | 11304 | Presser Bar (hollow) with 200074b..... | 80 |
| 204252 | 10441 | Presser Bar Lifter..... | 20 |
| 200550c | 10441 | Presser Bar Lifter Hinge Screw..... | 08 |

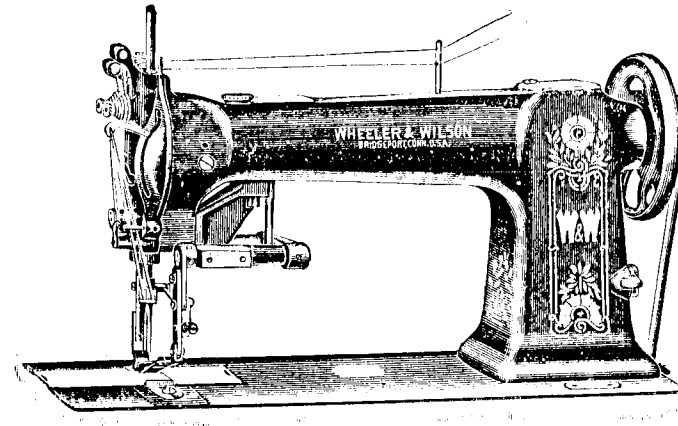
| No. | Plate | Name | Each |
|---------|-------|--|------|
| 204253 | 10441 | Presser Bar Lifting Bracket with 200086c | 40 |
| 200086c | 10441 | Presser Bar Lifting Bracket Pinch Screw | 03 |
| 204254 | 10441 | Presser Bar Lifting Bracket Position Guide with 200336..... | 30 |
| 200336 | 10441 | Presser Bar Lifting Bracket Position Guide Screw..... | 04 |
| 200362c | 10441 | Presser Bar Lifting Bracket Position Guide Set Screw..... | 03 |
| 203257 | 11010 | Presser Bar Packing Washer (felt) per 100..... | 25 |
| 200504 | 11010 | Presser Bar Screw Bushing (lower)..... | 05 |
| 204255 | 10441 | Presser Bar Spring (regular)..... | 10 |
| 200491B | 10441 | Presser Bar Thumb Screw (pressure regulating) | 25 |
| 203330 | 11303 | Presser Foot..... | 60 |
| 200074b | 10441 | Presser Foot Screw..... | 03 |
| 203331 | 11305 | Ruffling Blade..... | 35 |
| 202610 | 11305 | Ruffling Blade Clamp..... | 02 |
| 200174b | 11204 | Ruffling Blade Clamp Screw..... | 02 |
| 203332 | 11305 | Ruffling Blade Driving Eccentric..... | 25 |
| 203333 | 11305 | Ruffling Blade Driving Eccentric Arm Cap | 15 |
| 200582 | 11305 | Ruffling Blade Driving Eccentric Arm Screw | 02 |
| 203334 | 11305 | Ruffling Blade Driving Eccentric Connection | 75 |
| 200074b | 10441 | Ruffling Blade Driving Eccentric Connection Pinch Screw..... | 03 |
| 200101b | 11305 | Ruffling Blade Driving Eccentric Connection Stop Screw..... | 04 |
| 200382c | 11305 | Ruffling Blade Driving Eccentric Set Screw | 02 |
| 203335 | 11305 | Ruffling Blade Driving Eccentric Stop Washer | 05 |
| 200582 | 11305 | Ruffling Blade Driving Eccentric Stop Washer Screw..... | 02 |
| 203336 | 11306 | Ruffling Blade Driving Lever..... | 1 10 |
| 203337 | 11304 | Ruffling Blade Driving Lever 203336 with 200101b, 203338 and 203339..... | 1 25 |
| 203338 | 11306 | Ruffling Blade Driving Lever Shaft..... | 15 |
| 202574 | 11306 | Ruffling Blade Driving Lever Shaft Collar with 200380c..... | 15 |
| 200380c | 11202 | Ruffling Blade Driving Lever Shaft Collar Set Screw..... | 02 |
| 203339 | 11306 | Ruffling Blade Driving Lever Shaft Position Pin..... | 02 |
| 202668 | 11306 | Ruffling Blade Driving Lever Slide Block | 15 |
| 202597 | 11306 | Ruffling Blade Lever with 202610 and two 200174b | 1 25 |

| No. | Plate | Name | Each |
|---------|-------|--|------|
| *203340 | — | Ruffling Blade Lever Bracket (adjustable) | 25 |
| 203341 | 11306 | Ruffling Blade Lever Bracket (adjustable) 203340 with 202599b | 50 |
| 203342 | 11306 | Ruffling Blade Lever Bracket Crank with two each 200098b, 200382c and 202600 | 75 |
| 200382c | 11305 | Ruffling Blade Lever Bracket Crank Set Screw | 02 |
| 200098b | 10438 | Ruffling Blade Lever Bracket Screw | 03 |
| 202600 | 11202 | Ruffling Blade Lever Bracket Screw Washer | 01 |
| 200289 | 11202 | Ruffling Blade Lever Hinge Screw | 05 |
| 202607 | 11307 | Ruffling Blade Regulating Lever with two 200382c | 1 50 |
| 202608 | 11303 | Ruffling Blade Regulating Lever Index Slide | 25 |
| 203343 | 11303 | Ruffling Blade Regulating Lever Index Slide Stop | 25 |
| 200092 | 11204 | Ruffling Blade Regulating Lever Index Slide Stop Screw | 03 |
| 203349 | 11307 | Ruffling Blade Regulating Lever Index Slide Stop Screw Washer | 03 |
| 200382c | 11305 | Ruffling Blade Regulating Lever Set Screw | 02 |
| 203345 | 11307 | Ruffling Blade Regulating Lever Shaft .. | 25 |
| 226483 | 11212 | Ruffling Blade Regulating Lever Shaft 203345 with 203342 | 1 00 |
| 201600e | 11307 | Ruffling Blade Regulating Lever Wing Nut .. | 20 |
| 202609 | 11307 | Ruffling Blade Regulating Lever Shaft Nut Stud Slide | 35 |
| 203344 | 11307 | Ruffling Blade Regulating Lever Washer .. | 03 |
| 203346 | 11301 | Ruffling Bracket | 2 25 |
| 200033c | 11307 | Ruffling Bracket Position Screw | 05 |
| 200537c | 11307 | Ruffling Bracket Screw | 10 |
| 203347 | 11307 | Ruffling Separating Blade | 10 |
| 200157b | 11204 | Ruffling Separating Blade Screw | 05 |
| 202068 | 10710 | Spool Holder Base with 200079 | 15 |
| 200575 | 10710 | Spool Holder Base Screw | 05 |
| 204296 | 10710 | Spool Holder Base Wire | 10 |
| 200079 | 10710 | Spool Holder Base Wire Hinge Screw .. | 02 |
| 204297 | — | Spool Holder complete, Nos. 202068 and 204296 | 25 |
| 203268 | 11031 | Take-up Cam (formerly "V-3") with 200335c, 200383c, 200430c, 200658c and 201519c | 1 50 |
| 202325 | 11031 | Take-up Cam Friction Washer | 05 |
| 200430c | 11031 | Take-up Cam Position Screw | 08 |
| 200383c | 10435 | Take-up Cam Position Screw Check Screw | 02 |
| 200335c | 10434 | Take-up Cam Set Screw | 04 |

| No. | Plate | Name | Each |
|---------|-------|--|------|
| 203270 | 11010 | Take-up Lever (formerly "X") with 204265 | 60 |
| 204263 | 11031 | Take-up Lever Bearing with 204264 | 15 |
| 204264 | 11031 | Take-up Lever Bearing Position Pin | 01 |
| 200042c | 11031 | Take-up Lever Bearing Screw | 05 |
| 204265 | 11031 | Take-up Lever Oil Guard | 05 |
| 201816 | 11031 | Take-up Lever Roller | 12 |
| 203271 | 11010 | Take-up Lever (formerly "X") complete, Nos. 200042c, 201816, 203270 and 204263 .. | 90 |
| 202402 | 10443 | Tension Disc (back or front) | 05 |
| 202090 | 10443 | Tension Disc Position Pin | 01 |
| 204267 | 10443 | Tension Release Lever | 05 |
| 200309e | 10443 | Tension Release Lever Screw | 04 |
| 202075 | 10443 | Tension Release Plunger | 03 |
| 204268 | 10443 | Tension Release Slide with 204269 | 01 |
| 204269 | 10443 | Tension Release Slide Spring | 02 |
| 202407 | 10443 | Tension Spring (regular) | 05 |
| 200632b | 10493 | Tension Stud | 20 |
| 200385 | 10435 | Tension Stud Set Screw | 02 |
| 201572b | 10493 | Tension Thumb Nut | 04 |
| 204271 | 10443 | Tension Washer | 01 |
| 204272 | 10443 | Tension complete, Nos. 200632b, 201572b, 202075, 202407, 204271 and two 202402 .. | 50 |
| 201273 | 10444 | Thread Controller Adjusting Collar with 200684c (for presser bar) | 01 |
| 200384c | 10444 | Thread Controller Adjusting Collar Screw .. | 20 |
| 204274 | 10444 | Thread Controller Plate | 01 |
| 200577 | 10444 | Thread Controller Plate Screw | 01 |
| 202098 | 10444 | Thread Controller Roller | 05 |
| 204275 | 10444 | Thread Controller Roller Guard | 01 |
| 202084 | 10444 | Thread Controller Roller Guard Washer .. | 01 |
| 200300 | 10444 | Thread Controller Roller Screw | 04 |
| 204276 | 10444 | Thread Controller Spring (regular) | 03 |
| 204333 | 10444 | Thread Controller Spring Guard | 08 |
| 200581 | 10444 | Thread Controller Spring Guard Screw .. | 02 |
| 204277 | 10444 | Thread Controller Spring Stop | 15 |
| 204278 | 10444 | Thread Controller Spring Stop Driving Gear | 10 |
| 200319c | 10444 | Thread Controller Spring Stop Driving Gear Hinge Screw | 04 |
| 200135e | 10444 | Thread Controller Spring Stop Screw | 03 |
| 204279 | 10444 | Thread Controller Spring Stud with 201925 | 10 |
| 200366b | 10444 | Thread Controller Spring Stud Set Screw .. | 02 |
| 201925 | 11307 | Thread Controller Spring Stud Washer .. | 01 |
| 204280 | 10444 | Thread Controller complete, Nos. 200300, 200581, 202084, 202098, 204274 to 204276 and 204333 | 45 |

Digitized by srujanika@gmail.com

| No. | Plate | Name | Each |
|---------|-------|---|------|
| 202413 | 11010 | Thread Guide..... | 05 |
| 204281 | 10444 | Thread Retainer Guide Wire..... | 01 |
| 202091 | 10444 | Thread Retainer Sleeve..... | 05 |
| 202092 | 10444 | Thread Retainer Spring..... | 01 |
| 204058B | 10444 | Thread Retainer Stud..... | 07 |
| 200368 | 10444 | Thread Retainer Stud Set Screw..... | 02 |
| 204059 | — | Thread Retainer complete, Nos. 202091, 202092 and 204058B..... | 15 |
| 211001 | 11350 | Throat Plate, 50 needle hole, for needle sizes 3 to 5, for 203253 and 211002.... | 1 00 |
| 202061 | 11005 | Throat Plate Position Pin..... | 01 |
| 200577 | 10444 | Throat Plate Screw..... | 02 |



No. 27 w 20 MACHINE

TWO NEEDLE PLAIN RUFFLING MACHINE

May be Fitted with Any of the Two Needle Combinations in the
Following List.

Send Samples or Give a Full Description of Ruffles, Folds,
Heading, Gauges, Etc.

This Machine Can be Fitted to do Any Work Which Can be Done
on a Two Needle Ruffling Machine.

If the Combinations do not show the variety desired, send
samples and full description, and new
Combinations will be devised.

| No. | Plate | Name | Each |
|---------|-------|---|---------|
| *203326 | — | Arm with 202036..... | \$10 00 |
| 204163 | 10710 | Arm Cap..... | 10 |
| 200278 | 10710 | Arm Cap Screw..... | 05 |
| 202248 | 10710 | Arm Cap Screw Washer..... | 05 |
| 200016E | 10434 | Arm Screw..... | 06 |
| 202005 | 10434 | Arm Screw Washer..... | 01 |
| 203327 | 11301 | Arm Shaft..... | 2 00 |
| 204801 | — | Arm Shaft Bushing (back) with 202244.. | 35 |
| 202244 | 10279 | Arm Shaft Bushing (back) Oil Packing (wick) | 01 |
| 200338C | 11303 | Arm Shaft Bushing (back) Set Screw... | 04 |
| 204802 | — | Arm Shaft Bushing (front) with 202126 and 202244..... | 35 |
| 202244 | 10279 | Arm Shaft Bushing (front) Oil Packing (wick) | 01 |
| 200502B | 11303 | Arm Shaft Bushing (front) Oil Packing Thumb Screw..... | 25 |

| No. | Plate | Name | Each |
|--|-------|---|------|
| 202126 | 10434 | Arm Shaft Bushing (front) Position Pin | 01 |
| 200342c | 11303 | Arm Shaft Bushing (front) Set Screw | 03 |
| 204804 | 11301 | Arm Shaft Connection with 204166, 204167 and four 200054E | 80 |
| *204166 | — | Arm Shaft Connection Cap (lower) | — |
| *204167 | — | Arm Shaft Connection Cap (upper) | — |
| 200054E | 10434 | Arm Shaft Connection Cap Screw | 03 |
| 204805 | 11301 | Balance Wheel (power) 5½ in. diam. (belt groove 3 in. diam.) with 200328c and 200335c | 1 00 |
| Note: No. 204805 is sent with this Machine unless another Balance Wheel is specified on order. | | | |
| 204169B | — | Balance Wheel 5½ in. diam. with 200328c and 200335c for 204170 | 1 00 |
| 200062 | 10434 | Balance Wheel Adjusting Screw | 07 |
| 200328c | 10434 | Balance Wheel Position Screw | 04 |
| 204170 | — | Balance Wheel Pulley (loose) 3 in. diam. | 20 |
| 202015 | 10434 | Balance Wheel Pulley Spring Washer | 05 |
| 200335c | 10434 | Balance Wheel Set Screw | 04 |
| 201569B | 10434 | Balance Wheel Thumb Nut with 200609c | 25 |
| 200609c | 10434 | Balance Wheel Thumb Nut Stop Screw | 03 |
| 202016 | 10434 | Balance Wheel Thumb Nut Stop Screw Washer | 05 |
| 204172 | — | Balance Wheel (belt groove 3 in. diam.) complete, Nos. 201569, 202015, 202016, 204169n and 204170 | 1 70 |
| *203401 | — | Bed with 202061 | 8 00 |
| 202258 | 11003 | Bed Hinge Connection | 08 |
| 200570E | 10434 | Bed Hinge Connection Screw | 05 |
| 202259 | 11003 | Bed Hinge Plate with two ¾ in. No. 13 Wood Screws | 08 |
| 203206 | 11003 | Bed Slide (back) | 30 |
| 203301 | 11003 | Bed Slide (front) | 35 |
| 203208 | 11228 | Bobbin (formerly "F") | 05 |
| 203210 | 11228 | Bobbin Case Base with 202056, 203211 to 203213 and 203216 | 55 |
| *203211 | — | Bobbin Case Base Latch | 05 |
| *202056 | — | Bobbin Case Base Latch Pin | 01 |
| *203212 | — | Bobbin Case Base Latch Plunger | 02 |
| *203213 | — | Bobbin Case Base Latch Spring | 01 |
| 203209 | 11228 | Bobbin Case Cap with 200593, 203214, 203215 and two 200594c | 25 |
| 203214 | 11228 | Bobbin Case Tension Spring (formerly "4") | 05 |
| 200593 | 11228 | Bobbin Case Tension Spring Regulating Screw | 02 |
| 200594c | 11228 | Bobbin Case Tension Spring Screw | 02 |

| No. | Plate | Name | Each |
|---------|-------|--|------|
| 203215 | 11228 | Bobbin Case Thread Guide | 03 |
| 200594c | 11228 | Bobbin Case Thread Guide Screw | 02 |
| 203216 | 11228 | Bobbin Case Washer (cloth) Per 100 | 25 |
| 203217 | 11228 | Bobbin Case complete, Nos. 203209 and 203210 | 80 |
| 204533 | 11301 | Face Plate with 200366c, 204185, two each 200368c, 202090, 204281 and three 200385c | 1 10 |
| 200053c | 10435 | Face Plate Screw | 04 |
| 204185 | 10435 | Face Plate Thread Guide | 03 |
| 200385c | 10435 | Face Plate Thread Guide Set Screw | 02 |
| 203302 | 11301 | Face Plate complete, Nos. 200135, 200319, 200577, 204277 to 204280, 204533, 204555 two each 200309c, 204059 and 204272 | 3 50 |
| 203303 | 11032 | Feed Bar with 204189 | 50 |
| 200211c | 10435 | Feed Bar Hinge Screw | 12 |
| 204525E | 10435 | Feed Bar Hinge Screw Nut | 03 |
| 203304 | 11032 | Feed Bar Loop Guard | 25 |
| 200131c | 11032 | Feed Bar Loop Guard Screw | 02 |
| 204188 | 10435 | Feed Bar Spring | 03 |
| 204189 | 10435 | Feed Bar Spring Hook | 01 |
| 211010 | 11355 | Feed Dog (formerly "39") for 211011 | 60 |
| 200406E | 10435 | Feed Dog Screw | 02 |
| 203233 | 11005 | Feed Driving Cam (formerly "V-11") with 200378c and 200437c | 60 |
| 204192 | 10436 | Feed Driving Cam Fork-lever | 60 |
| 204193 | 11003 | Feed Driving Cam Fork-lever Connection with 200668c and 204525c | 35 |
| 204194 | 10438 | Feed Driving Cam Fork-lever Connection Clamp with 200031c | 45 |
| 200031c | 10438 | Feed Driving Cam Fork-lever Connection Clamp Pinch Screw | 04 |
| 200668c | 10438 | Feed Driving Cam Fork-lever Connection Clamp Screw Stud | 06 |
| 204525E | 10435 | Feed Driving Cam Fork-lever Connection Clamp Screw Stud Nut | 03 |
| 200002c | 10436 | Feed Driving Cam Fork-lever Connection Hinge Screw | 07 |
| 204522 | 10436 | Feed Driving Cam Fork-lever Connection Hinge Screw Nut | 03 |
| 204195 | 10436 | Feed Driving Cam Fork-lever Shaft | 15 |
| 204197 | 10436 | Feed Driving Cam Fork-lever Shaft Collar with 200113c | 15 |
| 200113c | 10436 | Feed Driving Cam Fork-lever Shaft Collar Set Screw | 03 |
| 204293 | 10436 | Feed Driving Cam Fork-lever Shaft Position Pin | 01 |

From the Library of Dagwood Needle Corp

| No. | Plate | Name | Each |
|---------|-------|--|------|
| 204196 | 10436 | Feed Driving Cam Fork-lever Shaft Sleeve (split)..... | 25 |
| 200043c | 10436 | Feed Driving Cam Fork-lever Shaft Sleeve Set Screw..... | 04 |
| 201524c | 10436 | Feed Driving Cam Fork-lever Shaft Sleeve Set Screw Nut..... | 03 |
| 204198 | 11304 | Feed Driving Cam Fork-lever complete, Nos. 204192, 204194, 204195 and 204293 | 1 30 |
| 200437c | 10436 | Feed Driving Cam Position Screw..... | 06 |
| 200378c | 10436 | Feed Driving Cam Set Screw..... | 02 |
| 204294 | 11301 | Feed Driving Rock Shaft..... | 35 |
| 202305c | 10436 | Feed Driving Rock Shaft Center..... | 06 |
| 200043c | 10436 | Feed Driving Rock Shaft Center Set Screw..... | 04 |
| 204200 | 10435 | Feed Driving Rock Shaft Crank with 204189 (on left side) and two 200383c.. | 35 |
| 200383c | 10435 | Feed Driving Rock Shaft Crank Set Screw | 02 |
| 200892 | 11005 | Feed Driving Rock Shaft Screw Center 200411 with 201512 (for repairs only)... | 10 |
| 201512 | --- | Feed Driving Rock Shaft Screw Center Nut (for repairs only)..... | 05 |
| 203235 | 11005 | Feed Lifting Cam (formerly "2") with 202126..... | 75 |
| 204202 | 11303 | Feed Lifting Cam Fork with 200027c.... | 75 |
| 200027c | 11005 | Feed Lifting Cam Fork Pinch Screw.... | 04 |
| 202126 | 10434 | Feed Lifting Cam Position Pin..... | 01 |
| 200045c | 11005 | Feed Lifting Cam Screw..... | 03 |
| 203305 | 11301 | Feed Lifting Rock Shaft..... | 35 |
| 202305c | 10436 | Feed Lifting Rock Shaft Center..... | 06 |
| 200043c | 10436 | Feed Lifting Rock Shaft Center Set Screw..... | 04 |
| *202276 | ----- | Feed Lifting Rock Shaft Slide Block.... | -- |
| 203238 | 11005 | Feed Lifting Rock Shaft Slide Block 202276 with 200243c and 201531..... | 35 |
| 200243c | 11005 | Feed Lifting Rock Shaft Slide Block Hinge Screw..... | 08 |
| 201531 | 11005 | Feed Lifting Rock Shaft Slide Block Hinge Screw Nut..... | 03 |
| 204206 | 11003 | Feed Regulating Handle..... | 10 |
| 204207 | 11003 | Feed Regulating Handle 204206 with 200098b, 202622, 204208 to 204210 and 204213..... | 55 |
| 204208 | 10438 | Feed Regulating Handle Adjustable Stop | 05 |
| 200098c | 10438 | Feed Regulating Handle Adjustable Stop Screw..... | 03 |
| 204209 | 10438 | Feed Regulating Handle Position Pin... | 01 |

| No. | Plate | Name | Each |
|---------|-------|--|------|
| 204210 | 10438 | Feed Regulating Handle Shaft..... | 20 |
| 204211 | 10438 | Feed Regulating Handle Shaft Crank with 200078c..... | 20 |
| 204212 | 10438 | Feed Regulating Handle Shaft Crank Link..... | 15 |
| 200271c | 10438 | Feed Regulating Handle Shaft Crank Link Hinge Screw (lower)..... | 05 |
| 200291c | 10438 | Feed Regulating Handle Shaft Crank Link Hinge Screw (upper)..... | 05 |
| 200078c | 10438 | Feed Regulating Handle Shaft Crank Set Screw..... | 03 |
| 204213 | 10438 | Feed Regulating Handle Shaft Sleeve (split)..... | 15 |
| 200362c | 10441 | Feed Regulating Handle Shaft Sleeve Set Screw..... | 03 |
| 202622 | 10438 | Feed Regulating Handle Shaft Sleeve Washer..... | 01 |
| 202036 | 10438 | Feed Regulating Handle Shaft Sleeve Stop Pin..... | 01 |
| 204211 | | Feed Regulating Handle complete, Nos. 200291c, 204207, 204211 and 204212.... | 15 |
| *203239 | | Hook (sewing)..... | 2 |
| 203240 | 11228 | Hook (sewing) 203239 with 200600, 200616 and 203251..... | 2 00 |
| 203290 | 11228 | Hook and Bobbin Case complete, Nos. 203217 and 203240..... | 3 00 |
| 203241 | 11007 | Hook bevel Gearsocket, 24 teeth, with 200555..... | 1 00 |
| 200555 | 11007 | Hook bevel Gearsocket Screw..... | 02 |
| 203242 | 11007 | Hook bevel Pinion, 24 teeth, with two 200383c..... | 1 00 |
| 200383c | 10435 | Hook bevel Pinion Set Screw..... | 02 |
| 203306 | 11304 | Hook Counter Shaft..... | 45 |
| 203244 | 11007 | Hook Counter Shaft Collar with two 200393c..... | 20 |
| 200393c | 11007 | Hook Counter Shaft Collar Set Screw.... | 02 |
| 203245 | 11007 | Hook Counter Shaft Driving Gear, 44 teeth, with 200362c and 200439c..... | 1 00 |
| 200439c | 10431 | Hook Counter Shaft Driving Gear Position Screw..... | 05 |
| 200362c | 10441 | Hook Counter Shaft Driving Gear Set Screw..... | 03 |
| 203246 | 11007 | Hook Counter Shaft Gear, 22 teeth, with two 200383c..... | 75 |
| 200383c | 10441 | Hook Counter Shaft Gear Set Screw.... | 02 |
| 202299 | 10279 | Hook Counter Shaft Oil Packing (wick) | 01 |
| 200840 | 11007 | Hook Counter Shaft Oil Packing (wick) Stop Screw..... | 10 |

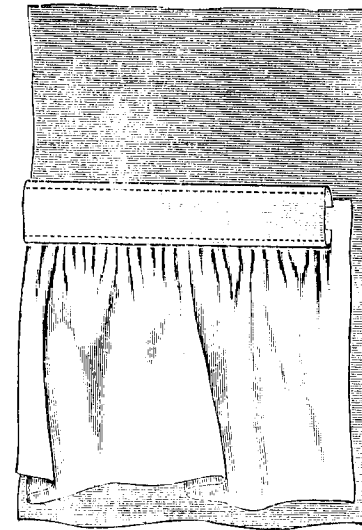
| No. | Plate | Name | Each |
|---------|-------|--|-------|
| 213624 | 11301 | Hook Driving Shaft..... | 1 75 |
| 203248 | 11304 | Hook Driving Shaft Bearing with 202126 and 202299..... | 20 |
| 202299 | 10279 | Hook Driving Shaft Bearing Oil Packing (wick) | 01 |
| 202126 | 10434 | Hook Driving Shaft Bearing Position Pin | 01 |
| 200516 | 10434 | Hook Driving Shaft Bearing Screw..... | 08 |
| 203249 | 11007 | Hook Driving Shaft Bushing (Eccentric) | 25 |
| 200362c | 10441 | Hook Driving Shaft Bushing Set Screw.. | 03 |
| 203250 | 11007 | Hook Driving Shaft Collar with two 200393c | 20 |
| 200393c | 11007 | Hook Driving Shaft Collar Set Screw.... | 02 |
| 203251 | 11228 | Hook Gib..... | 40 |
| 200600 | 11228 | Hook Gib Hinge Screw..... | 02 |
| 200616e | 11228 | Hook Gib Screw..... | 02 |
| 203307 | 11229 | Hook Saddle (left or right) with 202299 | 1 25 |
| 202299 | 10279 | Hook Saddle Oil Packing (wick)..... | 01 |
| 200006e | 11007 | Hook Saddle Screw..... | 07 |
| 225585 | 11007 | Hook Saddle Screw Washer..... | 02 |
| 203254 | 11228 | Hook Washer with 203255..... | 20 |
| *203255 | — | Hook Washer Pin..... | 01 |
| 203308 | 11229 | Hook Saddle complete, Nos. 200555, 203241, 203254, 203290 and 203307..... | 5 25 |
| 203462 | 11229 | Hook Saddle Combination (left and right) complete, Nos. two 203308..... | 10 50 |
| 203403 | 11304 | Needle Bar (hollow)..... | 80 |
| 204248 | 11010 | Needle Bar Connecting Link..... | 35 |
| 200658c | 11010 | Needle Bar Connecting Link Hinge Stud | 10 |
| 201519c | 11010 | Needle Bar Connecting Link Hinge Stud Nut | 03 |
| 204249 | 11010 | Needle Bar Connecting Stud with 200072c | 40 |
| 200072c | 11010 | Needle Bar Connecting Stud Pinch Screw | 03 |
| 200504 | 11010 | Needle Bar Screw Bushing (lower).... | 05 |
| 200503 | 11010 | Needle Bar Screw Bushing (upper).... | 05 |
| 203703 | 14501 | Needle Holder, made in gauges from $\frac{1}{16}$ in. to $\frac{1}{8}$ in. in steps of $\frac{1}{32}$ in. with 200068 and two 200141c..... | 1 00 |
| 203704 | 14501 | Needle Holder, made in gauges from $\frac{1}{8}$ in. to $\frac{1}{2}$ in. in steps of $\frac{1}{16}$ in. with 200068 and two 200141c..... | 1 25 |
| 203705 | 14501 | Needle Holder, made in gauges from $\frac{1}{4}$ in. to $\frac{3}{4}$ in. in steps of $\frac{1}{16}$ in. with 200068 and two 200141c..... | 1 50 |
| 200068 | 14501 | Needle Holder Screw..... | 03 |
| 200141 | 13084 | Needle Set Screw..... | 02 |
| 204251 | 11304 | Presser Bar (hollow) with 200074d..... | 80 |
| 204252 | 10441 | Presser Bar Lifter..... | 20 |
| 200550c | 10441 | Presser Bar Lifter Hinge Screw..... | 08 |

| No. | Plate | Name | Each |
|---------|-------|---|------|
| 204253 | 10441 | Presser Bar Lifting Bracket with 200086c | 40 |
| 200086c | 10441 | Presser Bar Lifting Bracket Pinch Screw | 03 |
| 204254 | 10441 | Presser Bar Lifting Bracket Position Guide with 200336..... | 30 |
| 200336 | 10441 | Presser Bar Lifting Bracket Position Guide Screw..... | 04 |
| 200362c | 10441 | Presser Bar Lifting Bracket Position Guide Set Screw..... | 03 |
| 203257 | 11010 | Presser Bar Packing Washer (felt) per 100..... | 25 |
| 204255 | 10441 | Presser Bar Spring (regular)..... | 10 |
| 200491b | 10441 | Presser Bar Thumb Screw (pressure regulating) | 25 |
| 203404 | 11303 | Presser Foot..... | |
| 200074d | 10441 | Presser Foot Screw..... | |
| 203405 | 11303 | Ruffling Blade..... | |
| 202610 | 11305 | Ruffling Blade Clamp..... | |
| 200174d | 11204 | Ruffling Blade Clamp Screw..... | |
| 203332 | 11305 | Ruffling Blade Driving Eccentric..... | 1 25 |
| 203333 | 11305 | Ruffling Blade Driving Eccentric Arm Cap | |
| 200582 | 11305 | Ruffling Blade Driving Eccentric Arm Cap Screw..... | |
| 203334 | 11305 | Ruffling Blade Driving Eccentric Con- nection | |
| 200074d | 10441 | Ruffling Blade Driving Eccentric Con- nection Pinch Screw..... | |
| 200101d | 11305 | Ruffling Blade Driving Eccentric Con- nection Stop Screw..... | |
| 200382c | 11305 | Ruffling Blade Driving Eccentric Set Screw | |
| 203335 | 11305 | Ruffling Blade Driving Eccentric Stop Washer | |
| 200582 | 11305 | Ruffling Blade Driving Eccentric Stop Washer Screw | 02 |
| 203336 | 11306 | Ruffling Blade Driving Lever..... | 1 10 |
| 203337 | 11304 | Ruffling Blade Driving Lever 203336 with 200101d, 203338 and 203339..... | 1 25 |
| 203338 | 11306 | Ruffling Blade Driving Lever Shaft..... | 15 |
| 202574 | 11306 | Ruffling Blade Driving Lever Shaft Collar with 200380c..... | 15 |
| 200380c | 11202 | Ruffling Blade Driving Lever Shaft Collar Set Screw..... | 02 |
| 203339 | 11306 | Ruffling Blade Driving Lever Shaft Posi- tion Pin..... | 02 |
| 202668 | 11306 | Ruffling Blade Driving Lever Slide Block | 15 |
| 202597 | 11306 | Ruffling Blade Lever with 202610 and two 200174d | 1 25 |

| No. | Plate | Name | Each |
|---------|-------|--|------|
| *203340 | 11202 | Ruffling Blade Lever Bracket (adjustable) | 25 |
| 203341 | 11306 | Ruffling Blade Lever Bracket (adjustable) 203340 with 202599b..... | 50 |
| 203342 | 11306 | Ruffling Blade Lever Bracket Crank with two each 200098b, 200382c and 202600 | 75 |
| 200382c | 11305 | Ruffling Blade Lever Bracket Crank Set Screw | 02 |
| 200098b | 10438 | Ruffling Blade Lever Bracket Screw..... | 03 |
| 202600 | 11202 | Ruffling Blade Lever Bracket Screw Washer | 01 |
| 200289 | 11202 | Ruffling Blade Lever Hinge Screw..... | 05 |
| 201537 | 11202 | Ruffling Blade Lever Hinge Screw Nut.. | 03 |
| 202598 | 11305 | Ruffling Blade Lever Spring..... | 05 |
| *200771 | — | Ruffling Blade Lever Spring Stud..... | — |
| 202599b | 11305 | Ruffling Blade Lever Spring Stud Bracket with 200771..... | 25 |
| 201566b | 11305 | Ruffling Blade Lever Spring Thumb Nut | 05 |
| 202603 | 11305 | Ruffling Blade Lever Spring Thumb Nut Washer | 01 |
| 202603 | 11305 | Ruffling Blade Lever Spring Washer.... | 01 |
| 202605b | 11306 | Ruffling Blade Lifting Lever..... | 25 |
| 200168c | 11306 | Ruffling Blade Lifting Lever Set Screw | 02 |
| 202606 | 11303 | Ruffling Blade Lifting Lever Stud (adjustable) | 45 |
| 200072c | 11040 | Ruffling Blade Lifting Lever Pinch Screw | 03 |
| 202607 | 11307 | Ruffling Blade Regulating Lever with two 200382c | 1 50 |
| 202608 | 11303 | Ruffling Blade Regulating Lever Index Slide | 25 |
| 203343 | 11303 | Ruffling Blade Regulating Lever Index Slide Stop..... | 25 |
| 200157b | 11204 | Ruffling Blade Regulating Lever Index Slide Stop Screw..... | 05 |
| 203349 | 11307 | Ruffling Blade Regulating Lever Index Slide Stop Screw Washer..... | 03 |
| 200382c | 11305 | Ruffling Blade Regulating Lever Set Screw | 02 |
| 203345 | 11307 | Ruffling Blade Regulating Lever Shaft .. | 25 |
| 201600b | 11307 | Ruffling Blade Regulating Lever Wing Nut | 20 |
| 202609 | 11307 | Ruffling Blade Regulating Lever Wing Nut Stud Slide..... | 35 |
| 203344 | 11307 | Ruffling Blade Regulating Lever Washer | 03 |
| 203346 | 11301 | Ruffling Bracket..... | 2 25 |
| 200033c | 11307 | Ruffling Bracket Position Screw..... | 05 |
| 200537c | 11307 | Ruffling Bracket Screw..... | 10 |
| 203407 | 11303 | Ruffling Separating Blade..... | 75 |
| 200157b | 11204 | Ruffling Separating Blade Screw..... | 05 |

| No. | Plate | Name | Each |
|---------|-------|---|------|
| 202068 | 10710 | Spool Holder Base with 200079..... | 15 |
| 204551 | — | Spool Holder Base Bracket (for two spools) | 15 |
| 200257b | 11032 | Spool Holder Base Bracket Screw..... | 08 |
| 200575 | 10710 | Spool Holder Base Screw..... | 05 |
| 204296 | 10710 | Spool Holder Base Wire..... | 10 |
| 200079 | 10710 | Spool Holder Base Wire Hinge Screw... | 02 |
| 204297 | — | Spool Holder complete, Nos. 202068 and 204296 | 25 |
| 204552 | 11301 | Spool Holder Base complete, Nos. 204551, two each 200575 and 204297..... | 75 |
| 203268 | 11031 | Take up Cam (formerly "V3") with 200335c, 200383c, 200430c, 200658c and 201519c | 1 50 |
| 202325 | 11031 | Take-up Cam Friction Washer..... | 1 50 |
| 200430c | 11031 | Take-up Cam Position Screw..... | 1 50 |
| 200383c | 10435 | Take-up Cam Position Screw Check Screw | 1 50 |
| 200335c | 10434 | Take-up Cam Set Screw..... | 1 50 |
| 204553 | — | Take-up Lever (formerly "O3") with 204265 | 1 50 |
| 204263 | 11031 | Take-up Lever Bearing with 204264.... | 1 50 |
| 204264 | 11031 | Take-up Lever Bearing Position Pin.... | 1 50 |
| 200042c | 11031 | Take-up Lever Bearing Screw..... | 1 50 |
| 204265 | 11031 | Take-up Lever Oil Guard..... | 1 50 |
| 201816 | 11031 | Take-up Lever Roller..... | 1 50 |
| 204554 | 11103 | Take-up Lever (formerly "O3") complete, Nos. 200042c, 201816, 204263 and 204553 | 1 50 |
| 202402 | 10443 | Tension Disc (back or front)..... | 1 50 |
| 202090 | 10443 | Tension Disc Position Pin..... | 1 50 |
| 204555 | 11032 | Tension Release Lever..... | 10 |
| 200309e | 10443 | Tension Release Lever Screw..... | 04 |
| 202075 | 10443 | Tension Release Plunger..... | 03 |
| 204268 | 10443 | Tension Release Slide with 204269..... | 10 |
| 204269 | 10443 | Tension Release Slide Spring..... | 02 |
| 202407 | 10443 | Tension Spring (regular)..... | 05 |
| 200632b | 10443 | Tension Stud | 20 |
| 200385c | 10435 | Tension Stud Set Screw..... | 02 |
| 201572b | 10443 | Tension Thumb Nut..... | 04 |
| 204271 | 10443 | Tension Washer..... | 05 |
| 204272 | 10443 | Tension complete, Nos. 200632b, 201572b, 202075, 202407, 204271 and two 202402.. | 50 |
| 204273 | 10444 | Thread Controller Adjusting Collar with 200684c (for presser bar)..... | 15 |
| 200684c | 10444 | Thread Controller Adjusting Collar Screw | 04 |
| 204274 | 10444 | Thread Controller Plate..... | 12 |
| 200577 | 10444 | Thread Controller Plate Screw..... | 02 |

| No. | Plate | Name | Each |
|---------|-------|---|------|
| 202098 | 10444 | Thread Controller Roller..... | 05 |
| 204275 | 10444 | Thread Controller Roller Guard..... | 10 |
| 202084 | 10444 | Thread Controller Roller Washer..... | 01 |
| 200300 | 10444 | Thread Controller Roller Guard Screw.. | 04 |
| 204276 | 10444 | Thread Controller Spring (regular)..... | 03 |
| 204333 | 10444 | Thread Controller Spring Guard..... | 08 |
| 200581 | 10444 | Thread Controller Spring Guard Screw.. | 02 |
| 204277 | 10444 | Thread Controller Spring Stop..... | 15 |
| 204278 | 10444 | Thread Controller Spring Stop Driving Gear | 10 |
| 200319c | 10444 | Thread Controller Spring Stop Driving Gear Hinge Screw..... | 04 |
| 200135e | 10444 | Thread Controller Spring Stop Screw.... | 03 |
| 204279 | 10444 | Thread Controller Spring Stud with 204925 | 10 |
| 200366c | 10444 | Thread Controller Spring Stud Set Screw | 02 |
| 204925 | 11307 | Thread Controller Spring Stud Washer | 01 |
| 204280 | 10444 | Thread Controller complete, Nos. 200300, 200581, 202084, 202098, 204274 to 204276 and 204333..... | 45 |
| 203314 | 11032 | Thread Guide..... | 05 |
| 204281 | 10444 | Thread Retainer Guide Wire..... | 01 |
| 202091 | 10444 | Thread Retainer Sleeve..... | 05 |
| 202092 | 10444 | Thread Retainer Spring..... | 01 |
| 204058B | 10444 | Thread Retainer Stud..... | 07 |
| 200368c | 10444 | Thread Retainer Stud Set Screw..... | 02 |
| 204059 | — | Thread Retainer complete, Nos. 202091, 202092 and 204058B..... | 15 |
| 211011 | 11358 | Throat Plate (formerly "99 F") 50 needle hole, for needle sizes 3 to 5, made in gauges from $\frac{1}{8}$ in. to $\frac{3}{8}$ in. in steps of $\frac{1}{32}$ in. for 203462 and 211010..... | 1 25 |
| 202064 | 11005 | Throat Plate Position Pin..... | 01 |
| 200577 | 10444 | Throat Plate Screw..... | 02 |



No. 22650 COMBINATION

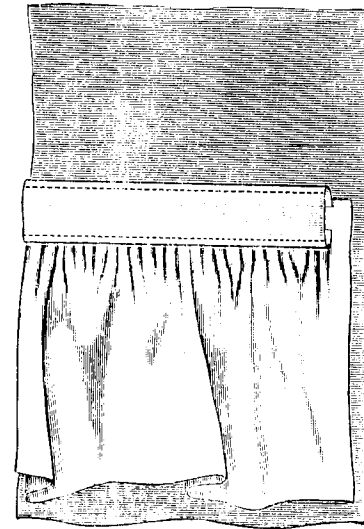
(FORMERLY No. 3)

Folder on Foot. Folds and Guides the Strip and Attaches it Over
the Ruffle for a Heading.

When Ordering, State Gauge Required.

| No. | Plate | Name | Each |
|---------|-------|---|------|
| 211010 | 11355 | Feed Dog (formerly "99") for 211011.... | 60 |
| 226491 | 11500 | Presser Foot and Strip Folder with two 200907B | 2 50 |
| 226495 | 11500 | Presser Foot and Strip Folder 226491 with 226496, 226497 and 226499..... | 3 75 |
| 226496 | 11500 | Ruffle Guide (adjustable)..... | 25 |
| 226497 | 11500 | Ruffle Guide Bracket with four 200174b | 75 |
| 200907B | 11204 | Ruffle Guide Bracket Screw..... | 02 |
| 200174b | 11204 | Ruffle Guide Screw..... | 02 |
| 226498 | 11500 | Ruffling Blade..... | 50 |
| 202610 | 11305 | Ruffling Blade Clamp..... | 02 |
| 200174b | 11204 | Ruffling Blade Clamp Screw..... | 02 |
| 202597 | 11306 | Ruffling Blade Lever with 202610 and two 200174b | 1 25 |
| *203340 | 11202 | Ruffling Blade Lever Bracket (adjust- able) | 25 |
| 203341 | 11306 | Ruffling Blade Lever Bracket 203340 with 202599B | 50 |

| No. | Plate | Name | Each |
|---------|-------|---|------|
| 202098 | 10444 | Thread Controller Roller..... | 05 |
| 204275 | 10444 | Thread Controller Roller Guard..... | 10 |
| 202084 | 10444 | Thread Controller Roller Guard Washer | 01 |
| 200300 | 10444 | Thread Controller Roller Guard Screw.. | 04 |
| 204276 | 10444 | Thread Controller Spring (regular)..... | 03 |
| 204333 | 10444 | Thread Controller Spring Guard..... | 08 |
| 200581 | 10444 | Thread Controller Spring Guard Screw.. | 02 |
| 204277 | 10444 | Thread Controller Spring Stop..... | 15 |
| 204278 | 10444 | Thread Controller Spring Stop Driving Gear | 10 |
| 200319c | 10444 | Thread Controller Spring Stop Driving Gear Hinge Screw..... | 04 |
| 200135E | 10444 | Thread Controller Spring Stop Screw.... | 03 |
| 204279 | 10444 | Thread Controller Spring Stud with 204925 | 10 |
| 200366c | 10444 | Thread Controller Spring Stud Set Screw | 02 |
| 204925 | 11307 | Thread Controller Spring Stud Washer | 01 |
| 204280 | 10444 | Thread Controller complete, Nos. 200300, 200581, 202084, 202098, 204274 to 204276 and 204333..... | 45 |
| 203314 | 11032 | Thread Guide..... | 05 |
| 204281 | 10444 | Thread Retainer Guide Wire..... | 01 |
| 202091 | 10444 | Thread Retainer Sleeve..... | 05 |
| 202092 | 10444 | Thread Retainer Spring..... | 01 |
| 204058R | 10444 | Thread Retainer Stud..... | 07 |
| 200368c | 10444 | Thread Retainer Stud Set Screw..... | 02 |
| 204059 | — | Thread Retainer complete, Nos. 202091, 202092 and 204058R..... | 15 |
| 211011 | 11358 | Throat Plate (formerly "99 F") 50 needle hole, for needle sizes 3 to 5, made in gauges from $\frac{1}{8}$ in. to $\frac{3}{8}$ in. in steps of $\frac{1}{16}$ in. for 203462 and 211010..... | 1 25 |
| 202064 | 11005 | Throat Plate Position Pin..... | 01 |
| 200577 | 10444 | Throat Plate Screw..... | 02 |



No. 226500 COMBINATION

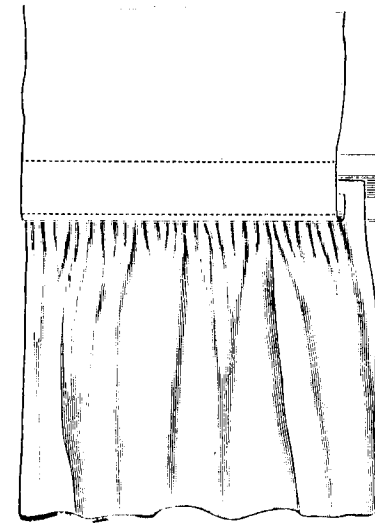
(FORMERLY No. 3)

Folder on Foot. Folds and Guides the Strip and Attaches it Over
the Ruffle for a Heading.

When Ordering, State Gauge Required.

| No. | Plate | Name | Each |
|---------|-------|---|------|
| 211010 | 11355 | Feed Dog (formerly "99") for 211011.... | 60 |
| 226494 | 11500 | Presser Foot and Strip Folder with two 200907R | 2 50 |
| 226495 | 11500 | Presser Foot and Strip Folder 226494 with 226496, 226497 and 226499..... | 3 75 |
| 226496 | 11500 | Ruffle Guide (adjustable)..... | 25 |
| 226497 | 11500 | Ruffle Guide Bracket with four 200174b | 75 |
| 200907R | 11204 | Ruffle Guide Bracket Screw..... | 02 |
| 200174b | 11204 | Ruffle Guide Screw..... | 02 |
| 226498 | 11500 | Ruffling Blade..... | 50 |
| 202610 | 11305 | Ruffling Blade Clamp..... | 02 |
| 200174b | 11204 | Ruffling Blade Clamp Screw..... | 02 |
| 202597 | 11306 | Ruffling Blade Lever with 202610 and two 200174b | 1 25 |
| *203340 | 11202 | Ruffling Blade Lever Bracket (adjust- able) | 25 |
| 203341 | 11306 | Ruffling Blade Lever Bracket 203340 with 202599R | 50 |

| No. | Plate | Name | Each |
|---------|-------|--|------|
| 203342 | 11306 | Ruffling Blade Lever Bracket Crank with two each 200098B, 200382c and 202600.. | 75 |
| 200382B | 11305 | Ruffling Blade Lever Bracket Crank Set Screw | 02 |
| 202600 | 11202 | Ruffling Blade Lever Bracket Screw Washer | 01 |
| 200289 | 11202 | Ruffling Blade Lever Hinge Screw..... | 05 |
| 201537 | 11202 | Ruffling Blade Lever Hinge Screw Nut.. | 03 |
| 202598 | 11305 | Ruffling Blade Lever Spring..... | 05 |
| *200771 | — | Ruffling Blade Lever Spring Stud..... | — |
| 202599B | 11305 | Ruffling Blade Lever Spring Stud Bracket with 200771..... | 25 |
| 201566B | 11305 | Ruffling Blade Lever Spring Thumb Nut | 05 |
| 202603 | 11305 | Ruffling Blade Lever Spring Thumb Nut Washer | 01 |
| 202603 | 11305 | Ruffling Blade Lever Spring Washer.... | 01 |
| 202605B | 11306 | Ruffling Blade Lifting Lever..... | 25 |
| 200168c | 11306 | Ruffling Blade Lifting Lever Set Screw.. | 02 |
| 202606 | 11303 | Ruffling Blade Lifting Lever Stud (adjustable) with 200072c and 200168c..... | 45 |
| 226340 | 11202 | Ruffling Blade Lifting Lever Stud 202606 with 202605B..... | 70 |
| 200072c | 11010 | Ruffling Blade Lifting Lever Stud Pinch Screw | 03 |
| 226499 | 11505 | Ruffling Separating Blade..... | 35 |
| 200174D | 11204 | Ruffling Separating Blade Screw..... | 02 |
| 211011 | 11358 | Throat Plate (formerly "99-F") 50 needle hole, for needle sizes 3 to 5, made in gauges $\frac{1}{4}$, $\frac{3}{8}$, $\frac{1}{2}$, $\frac{5}{8}$ and $\frac{3}{4}$ in., for 203462 and 211010..... | 1 25 |
| 226500 | — | Ruffling Combination No. 3 complete.... | 5 00 |



No. 226508 COMBINATION

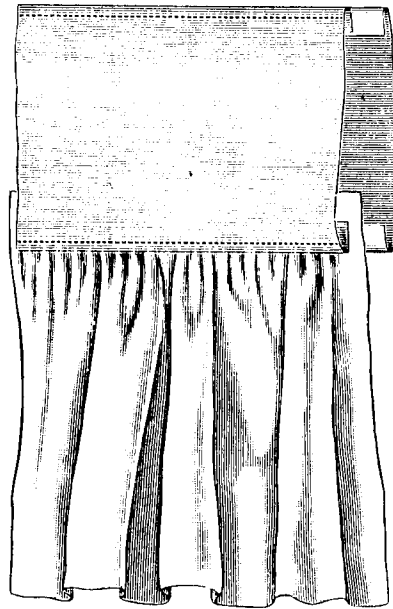
(FORMERLY No. 4)

Foldes the Strip, Folds the Edge of Material, Makes and Attaches the Ruffle Between the Folded Edge of Material on Top and the Folded Strip Underneath.

When Ordering, State Gauge Required.

| No. | Plate | Name | Each |
|---------|-------|---|------|
| 211010 | 11355 | Feed Dog (formerly "99") for 211011.... | 60 |
| 226501 | 11501 | Folder (plate) (strip) with two 200169.. | 2 50 |
| 200157B | 11204 | Folder (plate) Screw..... | 05 |
| 226502 | 11501 | Guide (on shank) with two 200174b.... | 1 75 |
| 200169 | 11204 | Guide Screw..... | 04 |
| 226503 | 11501 | Presser Foot with two 200183b..... | 1 25 |
| 226504 | 11501 | Presser Foot 226503 with 226505..... | 2 50 |
| 226505 | 11502 | Presser Foot Folder on Shank..... | 1 50 |
| 200183B | 11221 | Presser Foot Folder Screw..... | 02 |
| 226506 | 11502 | Ruffling Blade..... | 50 |
| 226507 | 11502 | Ruffling Separating Blade..... | 25 |
| 200174D | 11204 | Ruffling Separating Blade Screw..... | 02 |
| 211011 | 11358 | Throat Plate (formerly "99-F") 50 needle hole, for needle sizes 3 to 5, made in gauges $\frac{1}{4}$, $\frac{3}{8}$, $\frac{1}{2}$, $\frac{5}{8}$ and $\frac{3}{4}$ inch, for 203462 and 211010..... | 1 25 |
| 226508 | — | Ruffling Combination No. 4 complete.... | 5 00 |

From the library of: Diamond Needle Corp



No. 226516 COMBINATION

FORMERLY No 7.

Has Top and Bottom Folders, Folds the Four Edges in, Forming a Band, and Guides and Ruffles a Garment on the Right.

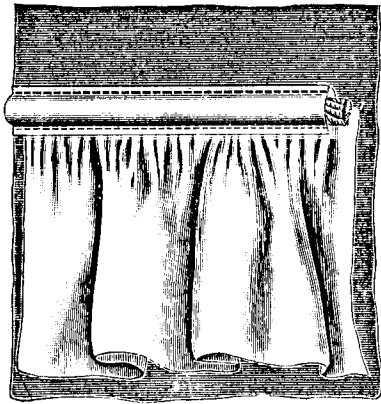
When Ordering, State Gauge Required.

| No. | Plate | Name | Each |
|---------|-------|--|-------|
| 211017 | 11357 | Feed Dog for 211015 and 211016..... | \$ 85 |
| 226509 | 11503 | Folder Plate (strip) with two 200169..... | 3 00 |
| 200157B | 11204 | Folder Plate Screw..... | 05 |
| 226510 | 11503 | Guide (on shank) with two 200174b..... | 2 00 |
| 200169 | 11204 | Guide Screw..... | 04 |
| 226511 | 11503 | Presser Foot (strip folder)..... | 3 00 |
| 226512 | 11503 | Ruffling Blade..... | 75 |
| 202610 | 11305 | Ruffling Blade Clamp..... | 02 |
| 200174b | 11204 | Ruffling Blade Clamp Screw..... | 02 |
| 202597 | 11306 | Ruffling Blade Lever with 202610 and two 200174b | 1 25 |
| 226404 | 11213 | Ruffling Blade Lever Bracket (adjust- able) | 50 |
| 226415 | 11216 | Ruffling Blade Lever Bracket 226404 with 200289, 201537, 201566b, 202597, 202598 and two 202603..... | 1 85 |

No. 226516 Combination

25

| No. | Plate | Name | Each |
|---------|-------|--|------|
| 226513 | 11502 | Ruffling Blade Lever Bracket Crank with two each 200098B, 200382c and 202600 | 75 |
| 200382c | 11305 | Ruffling Blade Lever Bracket Crank Set Screw | 02 |
| 200098B | 10438 | Ruffling Blade Lever Bracket Screw.... | 03 |
| 202600 | 11202 | Ruffling Blade Lever Bracket Screw Washer | 01 |
| 200289 | 11202 | Ruffling Blade Lever Hinge Screw..... | 05 |
| 201537 | 11202 | Ruffling Blade Lever Hinge Screw Nut.. | 03 |
| 202598 | 11305 | Ruffling Blade Lever Spring..... | 05 |
| 202599B | 11305 | Ruffling Blade Lever Spring Stud Bracket | 25 |
| 226514 | 11502 | Ruffling Blade Lifting Lever..... | 25 |
| 226515 | 11503 | Ruffling Separating Blade..... | 50 |
| 211015 | 11357 | Throat Plate (formerly "9-F") 50 needle hole, for needle sizes 3 to 5, made in gauges 1, 1 $\frac{1}{2}$, 1 $\frac{3}{8}$, 1 $\frac{1}{4}$, and 1 $\frac{1}{8}$ inch, for 203462 and 211017..... | 1 50 |
| 211016 | 11357 | Throat Plate, (formerly "9-F") 46 needle hole, for needle sizes 5 to 7, made in gauges 1, 1 $\frac{1}{2}$, 1 $\frac{3}{8}$, 1 $\frac{1}{4}$ and 1 $\frac{1}{8}$ inch for 203462 and 211017..... | 1 50 |
| 226516 | --- | Ruffling Combination No. 7 complete... 13 | 50 |



No. 226523 COMBINATION

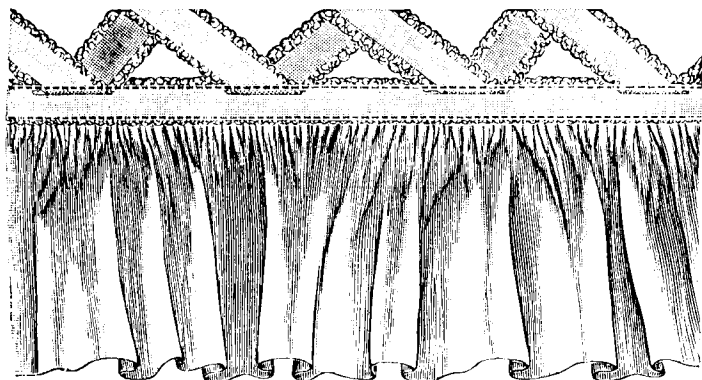
(FORMERLY No. 8)

Folds the Strip Over a Cord, Makes and Guides a Ruffle and Attaches to the Face of the Material.

When Ordering, State Gauge Required.

| No. | Plate | Name | Each |
|---------|-------|--|------|
| 211010 | 11355 | Feed Dog (formerly "99") for 211011.... | 60 |
| 226518 | 11504 | Presser Foot (cord guide and strip folder) with two 200164B..... | 3 50 |
| 226517 | 11504 | Presser Foot 226518 with 226519, 226520 and 226522..... | 5 00 |
| 226519 | 11504 | Ruffle Guide (adjustable)..... | 25 |
| 226520 | 11504 | Ruffle Guide Bracket with four 200178D.. | 1 00 |
| 200164B | 11208 | Ruffle Guide Bracket Screw..... | 02 |
| 200178D | 11203 | Ruffle Guide Screw..... | 02 |
| 226521 | 11504 | Ruffling Blade..... | 50 |
| 202610 | 11305 | Ruffling Blade Clamp..... | 02 |
| 200174D | 11204 | Ruffling Blade Clamp Screw..... | 02 |
| 202597 | 11306 | Ruffling Blade Lever with 202610 and two 200174D | 1 25 |
| 203341 | 11306 | Ruffling Blade Lever Bracket (adjustable) with 202599B..... | 50 |
| 203342 | 11306 | Ruffling Blade Lever Bracket Crank with two each 200098B, 200382c and 202600.. | 75 |
| 200382c | 11305 | Ruffling Blade Lever Bracket Crank Set Screw | 02 |
| 200098B | 10438 | Ruffling Blade Lever Bracket Screw.... | 03 |
| 202600 | 11202 | Ruffling Blade Lever Bracket Screw Washer | 01 |

| No. | Plate | Name | Each |
|---------|-------|--|------|
| 200289 | 11202 | Ruffling Blade Lever Hinge Screw..... | 05 |
| 201537 | 11202 | Ruffling Blade Lever Hinge Screw Nut.. | 03 |
| 202598 | 11305 | Ruffling Blade Lever Spring..... | 05 |
| 202599B | 11305 | Ruffling Blade Lever Spring Stud Bracket | 25 |
| 202605B | 11306 | Ruffling Blade Lifting Lever..... | 25 |
| 266522 | 11504 | Ruffling Separating Blade..... | 35 |
| 200178D | 11203 | Ruffling Separating Blade Screw..... | 02 |
| 211011 | 11358 | Throat Plate (formerly "99-F") 50 needle hole, for needle sizes 3 to 5, made in gauges $\frac{7}{8}$, $\frac{3}{4}$, $\frac{1}{2}$, $\frac{3}{16}$, $\frac{1}{8}$, $\frac{1}{16}$ and $\frac{1}{32}$ inch, for 203462 and 211010..... | 1 25 |
| 226523 | — | Ruffling Combination No. 8 complete.... | 5 50 |

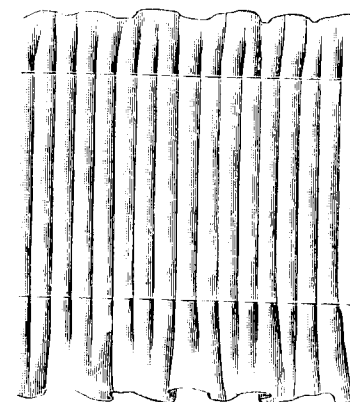


No. 226369 COMBINATION

(FORMERLY No. 9)

For Lace Curtain Work. Hems and Ruffles the Curtain, Making a Finished Heading, and at the Same Time Guides and Stitches Lace or Other Trimming on the Top.

| No. | Plate | Name | Each |
|--------|-------|--|------|
| 211002 | 11350 | Feed Dog (formerly "123") for 211001.... | 75 |
| 226364 | 11208 | Hemmer on Shank, turns the hem underneath | 2 25 |
| 200169 | 11204 | Hemmer Screw..... | 04 |
| 226365 | 11205 | Presser Foot with Lace Guide..... | 2 00 |
| 226366 | 11209 | Ruffling Blade..... | 35 |
| 226367 | 11208 | Ruffling Separating Blade on Plate, with two 200169..... | 75 |
| 226368 | 11205 | Ruffling Separating Blade 226367 with 226364 | 3 00 |
| 211001 | 11350 | Throat Plate, (formerly "123-F") 50 needle hole, for needle sizes 3 to 5, for 203253 and 211002..... | 1 00 |
| 226369 | — | Ruffling Combination No. 9 complete... | 4 50 |



No. 226528 COMBINATION

(FORMERLY No. 11)

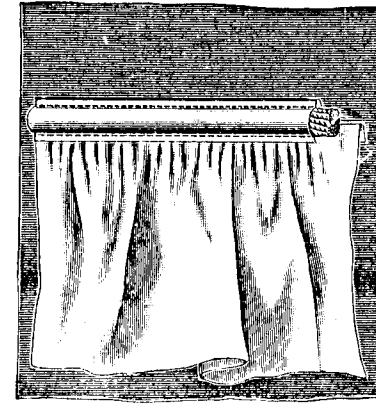
For Plain Ruffling and Shirring

When Ordering, State Gauge Required.

| No. | Plate | Name | Each |
|---------|-------|--|------|
| 211017 | 11357 | Feed Dog for 211015 and 211016..... | 85 |
| 226524 | 11503 | Presser Foot..... | 1 50 |
| 226525 | 11503 | Ruffling Blade..... | 50 |
| 202610 | 11305 | Ruffling Blade Clamp..... | 02 |
| 200174b | 11204 | Ruffling Blade Clamp Screw..... | 02 |
| 202597 | 11306 | Ruffling Blade Lever with 202610 and two 200174b..... | 25 |
| 226404 | 11213 | Ruffling Blade Lever Bracket (adjustable) with 202599b..... | 50 |
| 226415 | 11216 | Ruffling Blade Lever Bracket 226404 with 200289, 201537, 201566b, 202597, 202598 and two 202603..... | 1 85 |
| 226513 | 11502 | Ruffling Blade Lever Bracket Crank with two each 200098b, 200382c and 202600 | 75 |
| 200382c | 11305 | Ruffling Blade Lever Bracket Crank Set Screw | 02 |
| 200098b | 10138 | Ruffling Blade Lever Bracket Screw.... | 03 |
| 202600 | 11202 | Ruffling Blade Lever Bracket Screw Washer | 01 |
| 200289 | 11202 | Ruffling Blade Lever Hinge Screw..... | 05 |
| 201537 | 11202 | Ruffling Blade Lever Hinge Screw Nut.. | 03 |
| 202598 | 11305 | Ruffling Blade Lever Spring..... | 05 |
| 202599b | 11305 | Ruffling Blade Lever Spring Stud Bracket | 25 |
| 226514 | 11502 | Ruffling Blade Lifting Lever..... | 25 |

From the library of: Diamond Needle Corp

| No. | Plate | Name | Each |
|---------|-------|--|------|
| 226526 | 11503 | Ruffling Blade Reinforcement..... | 10 |
| 226527 | 11503 | Ruffling Separating Blade (on shank)... | 05 |
| 200157B | 11204 | Ruffling Separating Blade Screw..... | 05 |
| 211015 | 11357 | Throat Plate (formerly "9-F") 50 needle hole, for needle sizes 3 to 5, made in gauges 1, 1 $\frac{1}{32}$, 1 $\frac{1}{16}$, 1 $\frac{1}{8}$, 1 $\frac{3}{16}$ and 1 $\frac{1}{4}$ inch, for 203462 and 211017..... | 1 50 |
| 211016 | 11357 | Throat Plate (formerly "9-F") 46 needle hole, for needle sizes 5 to 7, made in gauges 1, 1 $\frac{1}{32}$, 1 $\frac{1}{16}$, 1 $\frac{1}{8}$ and 1 $\frac{1}{4}$ inch, for 203462 and 211017..... | 1 50 |
| 226528 | --- | Ruffling Combination No. 11 complete.. | 5 50 |



No. 226536 COMBINATION

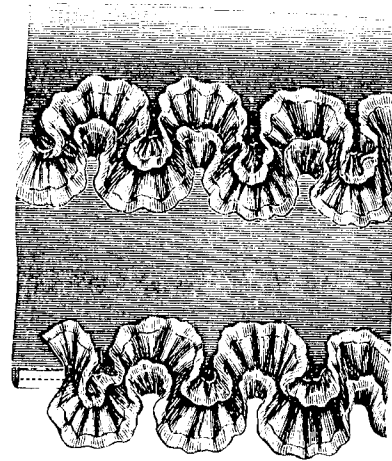
(FORMERLY No. 13)

Produces Work Similar to Combination No. 8, Except that it
Folds Down the Edge of the Ruffle to Face the Material.

When Ordering, State Gauge Required.

| No. | Plate | Name | Each |
|---------|-------|--|------|
| 211010 | 11355 | Feed Dog (formerly "99") for 211011.... | 60 |
| 226529 | 11505 | Presser Foot (cord guide and strip folder) with two 200164..... | 50 |
| 226530 | 11207 | Presser Foot 226529 with 226531, 226532 and 226535..... | 75 |
| 226531 | 11505 | Ruffle Folder (adjustable)..... | 00 |
| 226532 | 11505 | Ruffle Folder Bracket with four 200178D | 75 |
| 200178D | 11203 | Ruffle Folder Bracket Screw..... | 02 |
| 200178D | 11203 | Ruffle Folder Screw..... | 02 |
| 226534 | 11505 | Ruffling Blade..... | 50 |
| 202610 | 11305 | Ruffling Blade Clamp..... | 02 |
| 200174D | 11204 | Ruffling Blade Clamp Screw..... | 02 |
| 202597 | 11306 | Ruffling Blade Lever with 202610 and two 200174D | 1 25 |
| 203341 | 11306 | Ruffling Blade Lever Bracket (adjustable) with 202599B..... | 50 |
| 203342 | 11306 | Ruffling Blade Lever Bracket Crank with two each 200098B, 200382C and 202600 | 75 |
| 200382C | 11305 | Ruffling Blade Lever Bracket Crank Set Screw | 02 |
| 200098B | 10436 | Ruffling Blade Lever Bracket Screw.... | 03 |
| 202600 | 11202 | Ruffling Blade Lever Bracket Screw Washer | 01 |
| 200289 | 11202 | Ruffling Blade Lever Hinge Screw..... | 05 |

| No. | Plate | Name | Each |
|---------|-------|---|------|
| 201537 | 11202 | Ruffling Blade Lever Hinge Screw Nut.. | 03 |
| 202598 | 11305 | Ruffling Blade Lever Spring..... | 05 |
| 202599B | 11305 | Ruffling Blade Lever Spring Stud Bracket | 25 |
| 202605B | 11306 | Ruffling Blade Lifting Lever..... | 25 |
| 226535 | 11505 | Ruffling Separating Blade..... | 50 |
| 200178D | 11203 | Ruffling Separating Blade Screw..... | 02 |
| 211011 | 11358 | Throat Plate (formerly "99-F") 50 needle hole, for needle sizes 3 to 5, made in gauges $\frac{3}{8}$, $\frac{5}{16}$, $\frac{3}{16}$, $\frac{1}{4}$ and $\frac{5}{8}$ inch, for 203462 and 211010..... | 1 25 |
| 226536 | ---- | Ruffling Combination No. 13 complete.. | 4 50 |



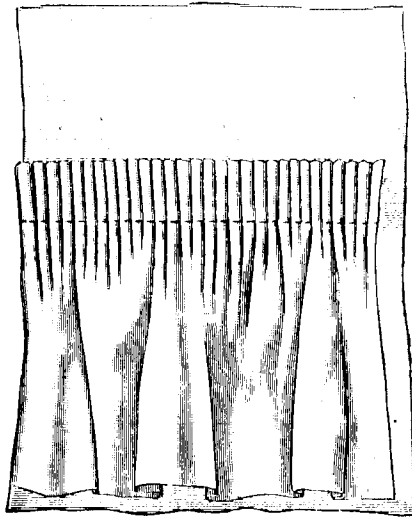
No. 226377 COMBINATION

(FORMERLY No. 17)

For Ruffling a Strip on to the Edge of a Garment for a Trimming. Hems the Edge of the Garment, Guides a Strip, Which Has Been Previously Hemmed on Both Edges, on to the Hem, Ruffles the Strip at the Center and Stitches it at One Operation.

| No. | Plate | Name | Each |
|---------|-------|---|------|
| 211002 | 11350 | Feed Dog (formerly "123") for 211001.. | 75 |
| 226370 | 11206 | Hemmer on Shank, for hemming the edge of a garment..... | 1 75 |
| 226371 | 11208 | Presser Foot with two 200164B..... | 1 00 |
| 226372 | 11206 | Presser Foot 226371, with 226375..... | 2 50 |
| 226373 | 11208 | Ruffle Guide (adjustable) for strips $\frac{3}{4}$ in. to $1\frac{1}{2}$ inch wide..... | 50 |
| 226374 | 11208 | Ruffle Guide Bracket with four 200175.. | 1 00 |
| 226375 | ---- | Ruffle Guide Bracket 226374 with 226373 and 226376..... | 1 75 |
| 200164B | 11208 | Ruffle Guide Bracket Screw..... | 02 |
| 200175 | 11202 | Ruffle Guide Screw..... | 02 |
| 203331 | 11305 | Ruffling Blade..... | 35 |
| 226376 | 11208 | Ruffling Separating Blade..... | 25 |
| 200175 | 11202 | Ruffling Separating Blade Screw..... | 02 |
| 211001 | 11350 | Throat Plate (formerly "123-F") 50 needle hole, for needle sizes 3 to 5, for 203253 and 211002..... | 1 00 |
| 226377 | ---- | Ruffling Combination No. 17 complete.. | 4 00 |

From the library of: Diamond Needle Corp



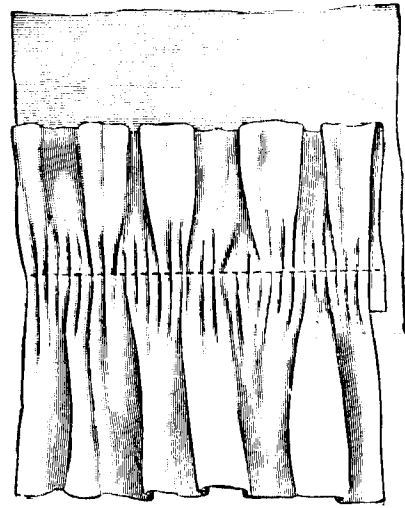
No. 226386 COMBINATION

(FORMERLY No. 25.)

Makes and Attaches a Plain Ruffle to the Face of the Material.
It Has a Right Hand and a Left Hand Guide for the
Ruffle. Either May Be Used.

| No. | Plate | Name | Each |
|--------|-------|--|------|
| 211002 | 11350 | Feed Dog (formerly "123") for 211001.... | 75 |
| 226378 | 11210 | Presser Foot with 200164B..... | 75 |
| 226379 | 11207 | Presser Foot 226378 with 225847..... | 2 00 |
| 226380 | — | Presser Foot 226379 with 226385..... | 3 00 |
| 226366 | 11209 | Ruffling Blade..... | 35 |
| 225856 | 11210 | Ruffling Separating Blade for 225847.... | 25 |
| 226382 | 11210 | Ruffling Separating Blade for 226385.... | 25 |
| 226383 | 11210 | Ruffling Separating Blade Bracket with two 200175, for guiding the ruffle in from the right..... | 1 00 |
| 225847 | — | Ruffling Separating Blade Bracket 226383 with 225856..... | 1 25 |
| 226384 | 11210 | Ruffling Separating Blade Bracket with two 200175, for guiding the ruffle in from the left..... | 1 00 |

| No. | Plate | Name | Each |
|---------|-------|--|------|
| 226385 | 11207 | Ruffling Separating Blade Bracket 226384 with 226382..... | 1 25 |
| 200164B | 11208 | Ruffling Separating Blade Bracket Screw | 02 |
| 200175 | 11202 | Ruffling Separating Blade Screw..... | 02 |
| 211001 | 11350 | Throat Plate, (formerly "123-F") 50 needle hole, for needle sizes 3 to 5, for 203253 and 211002..... | 1 00 |
| 226386 | — | Ruffling Combination No. 25 complete... | 4 00 |

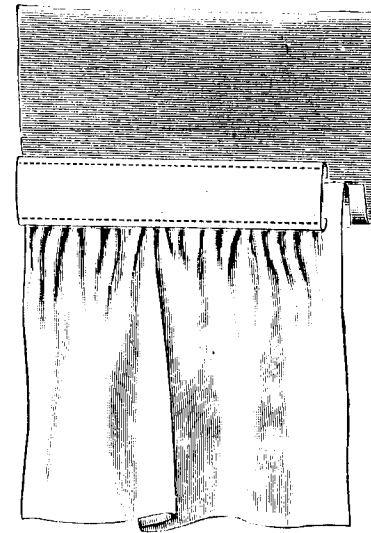


No. 226392 COMBINATION

(FORMERLY No. 26.)

For Making, Folding and Attaching a Ruffle Having a Wide Heading to the Face of Material.

| No. | Plate | Name | Each |
|---------------------------------------|-------|---|------|
| 211002 | 11350 | Feed Dog (formerly "123") for 211001.. | 75 |
| 226387 | 11210 | Folder on shank, with two 200179, folds the ruffle from the right for a heading | 4 75 |
| Note: State width of Folder required. | | | |
| 226388 | 11209 | Folder on Shank 226387 with 226391.... | 5 00 |
| 200169 | 11204 | Folder Screw..... | 02 |
| 203330 | 11303 | Presser Foot..... | 84 |
| 226366 | 11209 | Ruffling Blade..... | 35 |
| 226389 | 11209 | Guide on Base Plate with two 200169... | 1 50 |
| 226390 | — | Guide on Base Plate 226389 with 226388.. | 6 5- |
| 226391 | 11210 | Ruffling Separating Blade..... | 25 |
| 200179 | 11208 | Ruffling Separating Blade Screw..... | 0- |
| 211001 | 11350 | Throat Plate (formerly "123-F") 50 needle hole, for needle sizes 3 to 5, for 203253 and 211002..... | 1 0- |
| 226392 | — | Ruffling Combination No. 26 complete... | 8 5- |



No. 226551 COMBINATION

(FORMERLY No. 28.)

Folds the Edge of the Material, Guides a Strip Already Folded, Folds and Makes the Ruffle and Attaches All to Edge of the Material.

When Ordering, State Gauge Required.

| No. | Plate | Name | Each |
|---------|-------|---|------|
| 226537 | 11055 | Attachment Arm Switch (to the right) with 226455 and two 200157B..... | 2 00 |
| 226538 | 11506 | Attachment Arm Switch Bracket with 226398, two 228032 and three 200272.. | 1 50 |
| 226545 | — | Attachment Arm Switch Bracket 226538 with 226399, 226537, 226539 and 226540 | 5 30 |
| 200911D | 11213 | Attachment Arm Switch Bracket Screw | 05 |
| 226540 | 11507 | Attachment Arm Switch Latch..... | 75 |
| 200272B | 11213 | Attachment Arm Switch Latch Hinge Screw | 08 |
| 226398 | 11213 | Attachment Arm Switch Latch Hinge Screw Washer..... | 01 |
| 226399 | 11213 | Attachment Arm Switch Latch Spring... | 05 |

From the library of: Diamond Needle Corp

| No. | Plate | Name | Each |
|---------|-------|--|------|
| 200272B | 11213 | Attachment Arm Switch Screw..... | 08 |
| 228032 | 11213 | Attachment Arm Switch Screw Washer | 01 |
| 211010 | 11355 | Feed Dog (formerly "99") for 211008.... | 60 |
| 226548 | 11508 | Folder (on shank) (lower)..... | 1 50 |
| 226549 | 11508 | Folder (on shank) (upper)..... | 2 00 |
| 226547 | 11508 | Presser Foot (strip guide)..... | 1 75 |
| 226506 | 11502 | Ruffling Blade..... | 50 |
| 202610 | 11305 | Ruffling Blade Clamp..... | 02 |
| 200174D | 11204 | Ruffling Blade Clamp Screw..... | 02 |
| 202597 | 11306 | Ruffling Blade Lever with 202610 and two 200174D..... | 1 25 |
| 203340 | 11202 | Ruffling Blade Lever Bracket (adjust- able) | 25 |
| 203341 | 11306 | Ruffling Blade Lever Bracket 203340 with 202599B | 50 |
| 203342 | 11306 | Ruffling Blade Lever Bracket Crank with two each 200098A, 200382c and 202600 | 75 |
| 200382c | 11305 | Ruffling Blade Lever Bracket Crank Set Screw | 02 |
| 200098B | 10438 | Ruffling Blade Lever Bracket Screw.... | 03 |
| 202600 | 11202 | Ruffling Blade Lever Bracket Screw Washer | 01 |
| 200289 | 11202 | Ruffling Blade Lever Hinge Screw..... | 05 |
| 201537 | 11202 | Ruffling Blade Lever Hinge Screw Nut.. | 03 |
| 202598 | 11305 | Ruffling Blade Lever Spring..... | 05 |
| *200771 | — | Ruffling Blade Lever Spring Stud..... | — |
| 202599B | 11305 | Ruffling Blade Lever Spring Stud Bracket with 200771..... | 25 |
| 201566B | 11305 | Ruffling Blade Lever Spring Thumb Nut | 05 |
| 202603 | 11305 | Ruffling Blade Lever Spring Thumb Nut Washer | 01 |
| 202603 | 11305 | Ruffling Blade Lever Spring Washer.... | 01 |
| 202605B | 11306 | Ruffling Blade Lifting Lever..... | 25 |
| 200168c | 11306 | Ruffling Blade Lifting Lever Set Screw.. | 02 |
| 202606 | 11303 | Ruffling Blade Lifting Lever Stud(adjust- able) with 200072c and 200168c..... | 45 |
| 226340 | 11202 | Ruffling Blade Lifting Lever Stud 202606 with 202605B..... | 70 |
| 200072c | 11010 | Ruffling Blade Lifting Lever Stud Pinch Screw | 03 |

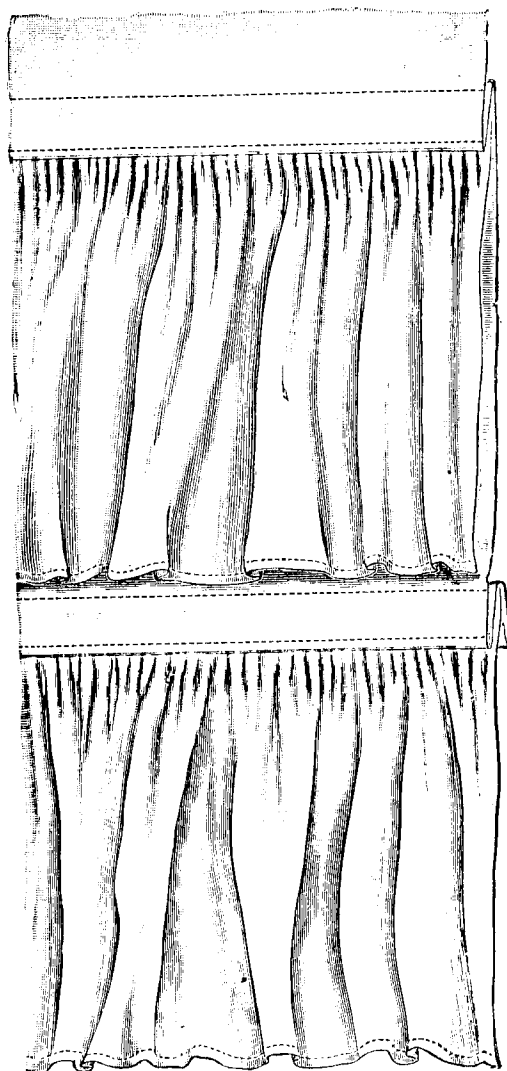
| No. | Plate | Name | Each |
|---------|-------|--|-------|
| 226550 | 11508 | Ruffling Separating Blade..... | 25 |
| 200174D | 11204 | Ruffling Separating Blade Screw..... | 02 |
| 211008 | 11355 | Throat Plate (formerly "99-A") 50 needle hole, for needle sizes 3 to 5, made in gauges $\frac{1}{8}$, $\frac{5}{32}$, $\frac{3}{16}$, $\frac{7}{32}$, $\frac{1}{4}$, $\frac{9}{32}$, $\frac{5}{16}$, $\frac{11}{32}$ and $\frac{3}{8}$ inch, for 203462 and 211010.. | 1 50 |
| 226544 | 11507 | Throat Plate Bolster..... | 25 |
| 200157B | 11204 | Throat Plate Bolster Screw..... | 05 |
| 200567 | 11507 | Throat Plate Screw..... | 05 |
| 226551 | — | Ruffling Combination No. 28 complete.. | 11 00 |

No. 226569 COMBINATION

(FORMERLY No. 33.)

For Making and Attaching Two or More Ruffles to a Skirt or to Similar Work. This Combination May Be Used on the Body Of the Material or on Its Edge. When Working on the Face of the Material it Makes a Fold in the Body of the Material and Guides the Ruffle Into It Making a Finished Heading. When Working on the Edge of the Material It Lays a Plait in the Material and Folds the Edge In, Guides the Edge of the Ruffle Into the Plait Making a Finished Heading.

When Ordering, State Gauge Required.



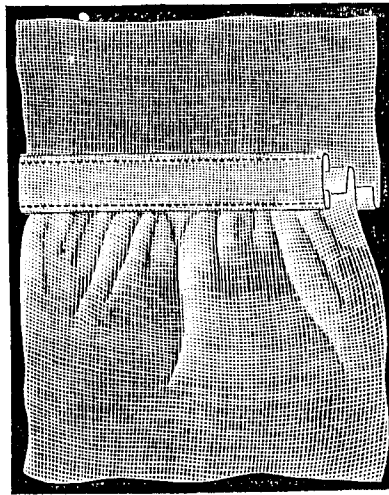
Specimen of Work Done on No. 226569 Combination.

| No. | Plate | Name | Each |
|---------|-------|--|------|
| 226393 | 11214 | Attachment Arm Switch to the right with two 200187..... | 1 25 |
| 226394 | 11214 | Attachment Arm Switch 226393 with 226397 and 226399..... | 2 15 |
| 226395 | 11214 | Attachment Arm Switch Bracket with 200272b, 228032 and two 200911..... | 1 25 |
| 226396 | 11211 | Attachment Arm Switch Bracket 226395 with 226394..... | 3 35 |
| 200272b | 11213 | Attachment Arm Switch Bracket Hinge Screw | 08 |
| 228032 | 11213 | Attachment Arm Switch Bracket Hinge Screw Washer..... | 01 |
| 226397 | 11213 | Attachment Arm Switch Latch with 200272b and 226398..... | 85 |
| 200272b | 11213 | Attachment Arm Switch Hinge Screw... | 08 |
| 226398 | 11213 | Attachment Arm Switch Hinge Screw Washer | 01 |
| 226399 | 11213 | Attachment Arm Switch Bracket Latch Spring | 05 |
| 200911 | 11213 | Attachment Arm Switch Bracket Screw | 05 |
| 226419 | 11217 | Bed Switch Locking Plate with two 200173 | 75 |
| 226559 | 11511 | Bed Switch Locking Plate Folder (on shank) | 1 75 |
| 226560 | 11511 | Bed Switch Guide (on shank)..... | 75 |
| 226416 | 11217 | Bed Switch with two 200173..... | 60 |
| 200305 | 11204 | Bed Switch Hinge Screw..... | 04 |
| 200175b | 11204 | Bed Switch Locking Plate Screw..... | 05 |
| 200173 | 11215 | Bed Switch Locking Plate Folder Screw | 04 |
| 226562 | 11224 | Bed Switch Locking Plate 226419 with 226416, 226559 and 226560..... | 3 75 |

From the library of: Diamond Needle Corp

| No. | Plate | Name | Each |
|---------|-------|---|------|
| 211010 | 11355 | Feed Dog (formerly "99") for 211009.... | 60 |
| 226561 | 11511 | Guide and Separating Blade (on shank) | 1 00 |
| 226563 | 11511 | Guide and Separating Blade Bracket (intermediate) with two 200183..... | 60 |
| 226564 | 11224 | Guide and Separating Blade Bracket 226563 with 226561..... | 1 60 |
| 200187 | 11213 | Guide and Separating Blade Bracket Screw | 04 |
| 202090 | 10443 | Presser Foot Hinge Pin..... | 01 |
| 226565 | — | Presser Foot Plate..... | 1 25 |
| 226566 | 11512 | Presser Foot Plate Spring..... | 25 |
| 200174D | 11204 | Presser Foot Plate Spring Screw..... | 02 |
| 226567 | 11512 | Presser Foot complete, Nos. 200174D, 202090, 226565 and 226566..... | 2 25 |
| 226568 | 11512 | Ruffling Blade..... | 50 |
| 202610 | 11305 | Ruffling Blade Clamp..... | 02 |
| 200174D | 11204 | Ruffling Blade Clamp Screw..... | 02 |
| 202597 | 11306 | Ruffling Blade Lever with 202610 and two 200174D | 1 25 |
| 202837 | 11218 | Ruffling Blade Lever Bracket with 202599B and two 202602..... | 1 75 |
| 202602 | 11215 | Ruffling Blade Lever Bracket Pin..... | 05 |
| *202973 | — | Ruffling Blade Lever Position Collar.... | — |
| *202974 | — | Ruffling Blade Lever Position Collar Position Pin..... | — |
| 226407 | 11215 | Ruffling Blade Lever Bracket Shaft with 200101D, 202973 and 202974..... | 1 25 |
| 226429 | 11211 | Ruffling Blade Lever Bracket Shaft 226407 with 200289B, 201537, 201566B, 202597, 202598, 202613, 202837 and two 202603 | 4 75 |
| 202613 | 11213 | Ruffling Blade Lever Bracket Spring.... | 03 |
| 200101B | 11305 | Ruffling Blade Lever Bracket Spring Screw | 04 |
| 200289B | 11202 | Ruffling Blade Lever Hinge Screw..... | 05 |
| 201537 | 11202 | Ruffling Blade Lever Hinge Screw Nut.. | 03 |
| 202598 | 11305 | Ruffling Blade Lever Spring..... | 05 |
| *200771 | — | Ruffling Blade Lever Spring Stud..... | — |
| 202599B | 11305 | Ruffling Blade Lever Spring Stud Bracket with 200771..... | 25 |
| 201566B | 11305 | Ruffling Blade Lever Spring Thumb Nut | 05 |
| 202603 | 11305 | Ruffling Blade Lever Spring Thumb Nut Washer | 01 |
| 202603 | 11305 | Ruffling Blade Lever Spring Washer.... | 01 |
| 226410 | 11211 | Switching Lever with 200043C, 200162, 200284 and 200909E..... | 1 60 |
| 226411 | 11211 | Switching Lever 226410 with 203935, 226348 and 226413..... | 3 00 |
| 226431 | — | Switching Lever 226411 with 226354..... | 4 00 |

| No. | Plate | Name | Each |
|---------|-------|---|------|
| 226347 | 11203 | Switching Lever Bell Crank..... | 50 |
| 226348 | 11206 | Switching Lever Bell Crank 226347 with 200659C and 201528C..... | 60 |
| 200909E | 11203 | Switching Lever Bell Crank Hinge Screw | 08 |
| 202668 | 11306 | Switching Lever Bell Crank Slide Block | 15 |
| 200659C | 11203 | Switching Lever Bell Crank Slide Block Screw Stud..... | 05 |
| 201528C | 11203 | Switching Lever Bell Crank Slide Block Screw Stud Nut..... | 01 |
| 202101 | 11201 | Switching Lever Bell Crank Slide Block Screw Stud Washer..... | 01 |
| 226413 | 11215 | Switching Lever Latch..... | 50 |
| 200284B | 11204 | Switching Lever Latch Hinge Screw.... | 05 |
| 203935 | 11215 | Switching Lever Latch Spring..... | 02 |
| 202027 | 11215 | Switching Lever Latch Spring Pin..... | 01 |
| 200162 | 11203 | Switching Lever Latch Stop Screw..... | 04 |
| 200043C | 10436 | Switching Lever Pinch Screw..... | 04 |
| 226353 | 11211 | Switching Lever Shaft..... | 35 |
| 226354 | 11211 | Switching Lever Shaft 226353 with 226355 and 226356..... | 00 |
| 202305C | 10436 | Switching Lever Shaft Center..... | 06 |
| 200043C | 10436 | Switching Lever Shaft Center Set Screw | 04 |
| 226355 | 11211 | Switching Lever Shaft Spring..... | 30 |
| 226356 | 11204 | Switching Lever Shaft Spring Collar with 200363C | 25 |
| 200363C | 11204 | Switching Lever Shaft Spring Collar Set Screw | 03 |
| 211009 | 11355 | Throat Plate (formerly "99-F-1") 50 needle, hole, for needle sizes 3 to 5, made in gauges from $\frac{1}{8}$ to $\frac{5}{8}$ in. in steps of $\frac{1}{32}$ in., for 203462 and 211010..... | 1 25 |
| 226569 | — | Ruffling Combination No. 33 complete... 19 | 00 |



No. 226616 COMBINATION

(FORMERLY No. 35.)

For Curtain Manufacture. Folds the Strip, Folds the Edges of the Curtain and the Ruffle. Has Stops for Instant Change to Scant or to Full Ruffling.

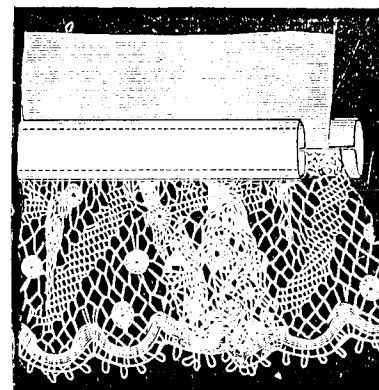
When Ordering, State Gauge Required.

| No. | Plate | Name | Each |
|---------|-------|---|------|
| 211010 | 11355 | Feed Dog (formerly "99") for 211011..... | 60 |
| 226604 | 11518 | Folder on Shank (lower)..... | 1 50 |
| 200174D | 11204 | Folder (lower) Screw..... | 02 |
| 226605 | 11518 | Folder on Shank (upper) with two 200174D | 2 00 |
| 200173 | 11215 | Folder (upper) Screw..... | 04 |
| 226606 | 11519 | Folder Base Plate with two each 200173 and 200174D..... | 1 00 |
| 225708 | 11226 | Folder Base Plate Spring..... | 10 |
| 200246B | 11226 | Folder Base Plate Hinge Screw..... | 08 |
| 200483B | 11514 | Folder Base Plate Thumb Screw..... | 06 |
| 226607 | 11519 | Folder Base Plate 226606 with 200246B, 200483B, 225708, 226604, 226605 and 226608 | 4 50 |
| 226617 | 11519 | Guide (for operators use in turning corner) | 25 |
| 226609 | 11520 | Presser Foot (strip folder)..... | 2 50 |
| 226608 | 11515 | Ruffling Separating Blade..... | 25 |
| 226506 | 11502 | Ruffling Blade..... | 50 |
| 202610 | 11305 | Ruffling Blade Clamp..... | 02 |
| 200174D | 11204 | Ruffling Blade Clamp Screw..... | 02 |

| No. | Plate | Name | Each |
|---------|-------|--|------|
| 202668 | 11306 | Ruffling Blade Driving Lever Slide Block | 15 |
| 202597 | 11306 | Ruffling Blade Lever with 202610 and two 200174D | 1 25 |
| *203340 | 11202 | Ruffling Blade Lever Bracket (adjustable) | 25 |
| 203341 | 11306 | Ruffling Blade Lever Bracket (adjustable) 203340 with 202599B..... | 50 |
| 203342 | 11306 | Ruffling Blade Lever Bracket Crank with two each 200098B, 200382C and 202600.. | 75 |
| 200382C | 11305 | Ruffling Blade Lever Bracket Crank Set Screw | 02 |
| 200098B | 10138 | Ruffling Blade Lever Bracket Screw.... | 03 |
| 202600 | 11202 | Ruffling Blade Lever Bracket Screw Washer | 01 |
| 200289 | 11202 | Ruffling Blade Lever Hinge Screw..... | 05 |
| 201537 | 11202 | Ruffling Blade Lever Hinge Screw Nut.. | 03 |
| 202598 | 11305 | Ruffling Blade Lever Spring..... | 05 |
| *200771 | --- | Ruffling Blade Lever Spring Stud..... | 01 |
| 202599B | 11305 | Ruffling Blade Lever Spring Stud Bracket with 200771..... | 25 |
| 201566B | 11305 | Ruffling Blade Lever Spring Thumb Nut | 05 |
| 202603 | 11305 | Ruffling Blade Lever Spring Thumb Nut Washer | 01 |
| 202603 | 11305 | Ruffling Blade Lever Spring Washer.... | 01 |
| 202605B | 11306 | Ruffling Blade Lifting Lever..... | 25 |
| 200168C | 11306 | Ruffling Blade Lifting Lever Set Screw.. | 02 |
| 202606 | 11303 | Ruffling Blade Lifting Lever Stud (adjustable) | 45 |
| 200072C | 11010 | Ruffling Blade Lifting Lever Pinch Screw | 03 |
| 226610 | 11520 | Ruffling Blade Regulating Lever with two each 200183D and 200382C..... | 1 50 |
| 226611 | 11520 | Ruffle Regulating Lever with 200179D (for making a full ruffle at the corner) | 50 |
| 226612 | 11520 | Ruffle Regulating Lever Spring..... | 25 |
| 226613 | 11520 | Ruffle Regulating Lever Stop..... | 25 |
| 200179D | 11208 | Ruffle Regulating Lever Spring Screw... | 02 |
| 200183D | 11221 | Ruffle Regulating Lever Stop Screw.... | 02 |
| 226614 | 11521 | Ruffle Regulating Lever 226611 with 226612 | 75 |
| 226410 | 11211 | Switching Lever with 200043C, 200162, 200284 and 200909E..... | 1 60 |
| 226615 | 11211 | Switching Lever 226410 with 226348, 202668, 202104 and 226614..... | 3 25 |
| 226791 | --- | Switching Lever 226615 with 226354..... | 4 25 |
| 226347 | 11203 | Switching Lever Bell Crank..... | 50 |
| 226348 | 11206 | Switching Lever Bell Crank 226347 with 200659C and 201528D..... | 60 |
| 200909C | 11203 | Switching Lever Bell Crank Hinge Screw | 08 |

From the library of Damarcus Needle Co.

| No. | Plate | Name | Each |
|---------|-------|--|-------|
| 202668 | 11306 | Switching Lever Bell Crank Slide Block | 15 |
| 200659c | 11203 | Switching Lever Bell Crank Slide Block Screw Stud..... | 05 |
| 201528c | 11203 | Switching Lever Bell Crank Slide Block Screw Stud Nut..... | 04 |
| 202104 | 11204 | Switching Lever Bell Crank Slide Block Screw Stud Washer..... | 01 |
| 200284B | 11204 | Switching Lever Latch Hinge Screw.... | 05 |
| 200162D | 11203 | Switching Lever Latch Stop Screw..... | 04 |
| 200043c | 10436 | Switching Lever Pinch Screw..... | 04 |
| 226353 | 11211 | Switching Lever Shaft..... | 35 |
| 226354 | 11211 | Switching Lever Shaft 226353 with 226355 and 226356..... | 1 00 |
| 202305c | 10436 | Switching Lever Shaft Center..... | 06 |
| 200043c | 10436 | Switching Lever Shaft Center Set Screw | 04 |
| 226355 | 11211 | Switching Lever Shaft Spring..... | 30 |
| 226356 | 11204 | Switching Lever Shaft Spring Collar with 200363c..... | 25 |
| 200363c | 11204 | Switching Lever Shaft Spring Set Screw | 03 |
| 211011 | 11358 | Throat Plate (formerly "99-F") 50 needle hole, for needle sizes 3 to 5, made in gauges $\frac{1}{8}$, $\frac{3}{16}$, $\frac{1}{4}$, $\frac{5}{16}$ and $\frac{3}{8}$ inch, for 203462 and 211010..... | 1 25 |
| 226616 | — | Ruffling Combination No. 35 complete... | 13 50 |



No. 226557 COMBINATION

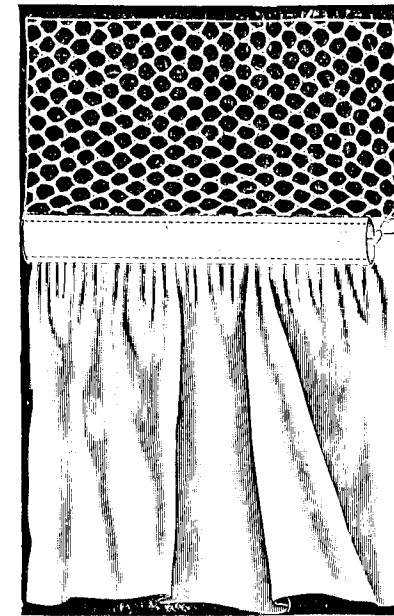
(FORMERLY No. 37.)

For Sewing Lace in Corset Cover Arm Holes. It Folds the Upper
and Under Strips and Guides the Material and Lace
Between the Strips.

When Ordering, State Gauge Required.

| No. | Plate | Name | Each |
|---------|-------|--|------|
| 226537 | 11506 | Attachment Arm Switch (to the right) with 226455 and two 200157B..... | 2 00 |
| 226538 | 11506 | Attachment Arm Switch Bracket with 226398, two 228032 and three 200272... | 1 50 |
| 226545 | — | Attachment Arm Switch Bracket 226538 with 226399, 226537, 226539 and 226540 | 5 30 |
| 226540 | 11507 | Attachment Arm Switch Bracket Latch.. | 75 |
| 200272B | 11213 | Attachment Arm Switch Bracket Latch Hinge Screw..... | 08 |
| 226398 | 11213 | Attachment Arm Switch Bracket Latch Hinge Screw Washer..... | 01 |
| 226399 | 11213 | Attachment Arm Switch Bracket Latch Spring..... | 05 |
| 200911D | 11213 | Attachment Arm Switch Bracket Screw | 05 |
| 200272B | 11213 | Attachment Arm Switch Screw..... | 08 |
| 228032 | 11213 | Attachment Arm Switch Screw Washer | 01 |
| 211010 | 11355 | Feed Dog (formerly "99") for 211011.... | 60 |
| 226552 | 11509 | Folder (on shank) for folding the under strip..... | 2 50 |
| 200157 | 11204 | Folder Screw..... | 05 |
| 226553 | 11509 | Guide (upper)..... | 50 |
| 226554 | 11509 | Guide (lower)..... | 50 |

| No. | Plate | Name | Each |
|---------|-------|---|-------|
| 226539 | 11506 | Guide Bracket (intermediate) with two two 200175d and four 200174..... | 1 00 |
| 200174d | 11204 | Guide Screw..... | 02 |
| 226555 | 11509 | Presser Foot (strip folder)..... | 2 50 |
| 226506 | 11502 | Ruffling Blade..... | 50 |
| 202610 | 11305 | Ruffling Blade Clamp..... | 02 |
| 200174d | 11204 | Ruffling Blade Clamp Screw..... | 02 |
| 202597 | 11306 | Ruffling Blade Lever with 202610 and two 200174d..... | 1 25 |
| *203340 | 11202 | Ruffling Blade Lever Bracket (adjustable)..... | 25 |
| 203341 | 11306 | Ruffling Blade Lever Bracket (adjustable) with 202599b..... | 50 |
| 203342 | 11306 | Ruffling Blade Lever Bracket Crank with two each 200098b, 200382c and 202600..... | 75 |
| 200382c | 11305 | Ruffling Blade Lever Crank Set Screw..... | 02 |
| 200098B | 10438 | Ruffling Blade Lever Bracket Screw..... | 03 |
| 202600 | 11202 | Ruffling Blade Lever Bracket Screw Washer..... | 01 |
| 200289 | 11202 | Ruffling Blade Lever Hinge Screw..... | 05 |
| 201537 | 11202 | Ruffling Blade Lever Hinge Screw Nut..... | 03 |
| 202598 | 11305 | Ruffling Blade Lever Spring..... | 05 |
| *200771 | — | Ruffling Blade Lever Spring Stud..... | — |
| 202599B | 11305 | Ruffling Blade Lever Spring Stud Bracket with 200771..... | 25 |
| 201566B | 11305 | Ruffling Blade Lever Spring Thumb Nut..... | 05 |
| 202603 | 11305 | Ruffling Blade Lever Spring Thumb Nut Washer..... | 01 |
| 202603 | 11305 | Ruffling Blade Lever Spring Washer..... | 01 |
| 202605B | 11306 | Ruffling Blade Lifting Lever..... | 25 |
| 200168c | 11306 | Ruffling Blade Lifting Lever Set Screw..... | 02 |
| 202606 | 11303 | Ruffling Blade Lifting Lever Stud (adjustable) with 200072c and 200168c..... | 45 |
| 226340 | 11202 | Ruffling Blade Lifting Lever Stud 202606 with 202605b..... | 70 |
| 200072c | 11010 | Ruffling Blade Lifting Lever Stud Pinch Screw..... | 03 |
| 226556 | 11509 | Ruffling Separating Blade..... | 35 |
| 200174d | 11204 | Ruffling Separating Blade Screw..... | 02 |
| 211011 | 11358 | Throat Plate (formerly "99-F") 50 needle hole, for needle sizes 3 to 5, made in gauges 1, 2, 3, 4, 5 and 3/4 inch, for 203462 and 211010..... | 1 25 |
| 226557 | — | Ruffling Combination No. 37 complete..... | 12 00 |



No. 226578 COMBINATION

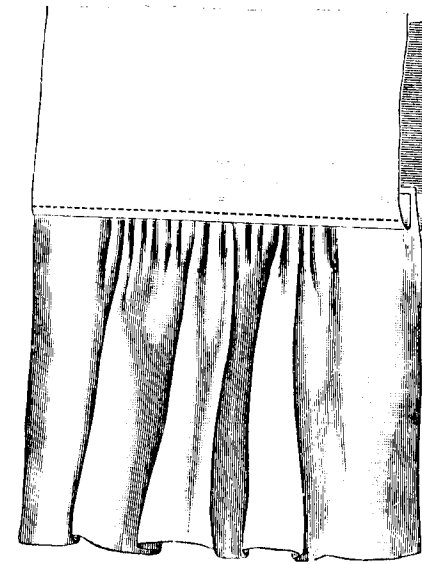
(FORMERLY No. 40.)

For Curtain Manufacture. It Folds the Edge of the Ruffle, Folds Both Edges of the Strip and Guides in Edge of Lace.

When Ordering, State Gauge Required.

| No. | Plate | Name | Each |
|---------|-------|---|------|
| 211010 | 11355 | Feed Dog (formerly "99") for 211011..... | 60 |
| 226570 | 11512 | Folder (plate) with two 200173..... | 2 00 |
| 226571 | 11512 | Folder (plate) 226570 with 226576, 226577 and two 200174..... | 3 00 |
| 200157 | 11204 | Folder (plate) Screw..... | 05 |
| 226572 | 11513 | Guide (on shank)..... | 1 50 |
| 200183 | 11221 | Guide Screw..... | 02 |
| 226573 | 11513 | Presser Foot with two 200183..... | 2 50 |
| 226574 | 11513 | Presser Foot 226573 with 226572..... | 4 00 |
| 226575 | 11513 | Ruffling Blade..... | 50 |
| 202610 | 11305 | Ruffling Blade Clamp..... | 02 |
| 200174d | 11204 | Ruffling Blade Clamp Screw..... | 02 |
| 202668 | 11306 | Ruffling Blade Driving Lever Slide Block..... | 15 |
| 202597 | 11306 | Ruffling Blade Lever with 202610 and two 200174d..... | 1 25 |

| No. | Plate | Name | Each |
|---------|-------|---|-------|
| *203340 | 11202 | Ruffling Blade Lever Bracket (adjustable) | 25 |
| 203341 | 11306 | Ruffling Blade Lever Bracket (adjustable) 203340 with 202599B..... | 50 |
| 203342 | 11306 | Ruffling Blade Lever Bracket Crank with two each 200098B, 200382C and 202600 | 75 |
| 200382C | 11305 | Ruffling Blade Lever Bracket Crank Set Screw | 02 |
| 200098B | 10438 | Ruffling Blade Lever Bracket Screw.... | 03 |
| 202600 | 11202 | Ruffling Blade Lever Bracket Screw Washer | 01 |
| 200289 | 11202 | Ruffling Blade Lever Hinge Screw..... | 05 |
| 201537 | 11202 | Ruffling Blade Lever Hinge Screw Nut.. | 03 |
| 202598 | 11305 | Ruffling Blade Lever Spring..... | 05 |
| *200771 | — | Ruffling Blade Lever Spring Stud..... | — |
| 202599B | 11305 | Ruffling Blade Lever Spring Stud Bracket with 200771..... | 25 |
| 201566B | 11305 | Ruffling Blade Lever Spring Thumb Nut | 05 |
| 202603 | 11305 | Ruffling Blade Lever Spring Thumb Nut Washer | 01 |
| 202603 | 11305 | Ruffling Blade Lever Spring Washer.... | 01 |
| 202605B | 11306 | Ruffling Blade Lifting Lever..... | 25 |
| 200168C | 11305 | Ruffling Blade Lifting Lever Set Screw.. | 02 |
| 202606 | 11303 | Ruffling Blade Lifting Lever Stud (adjustable) | 45 |
| 200072C | 11010 | Ruffling Blade Lifting Lever Pinch Screw | 03 |
| 202607 | 11307 | Ruffling Blade Regulating Lever with two 200382C | 1 50 |
| 202608 | 11303 | Ruffling Blade Regulating Lever Index Slide | 25 |
| 203343 | 11303 | Ruffling Blade Regulating Lever Index Slide Stop..... | 25 |
| 200157B | 11204 | Ruffling Blade Regulating Lever Index Slide Stop Screw..... | 05 |
| 203349 | 11307 | Ruffling Blade Regulating Lever Index Slide Stop Screw Washer..... | 03 |
| 226576 | 11513 | Ruffling Separating Blade..... | 50 |
| 200174D | 11204 | Ruffling Separating Blade Screw..... | 02 |
| 226577 | 11513 | Ruffling Separating Blade Bracket with two 200174D..... | 50 |
| 200173 | 11215 | Ruffling Separating Blade Bracket Screw | 01 |
| 211011 | 11358 | Throat Plate (formerly "99-F") 50 needle hole, for needle sizes 3 to 5, made in gauges $\frac{1}{8}$, $\frac{3}{16}$, $\frac{1}{4}$, $\frac{5}{16}$ and $\frac{3}{8}$ inch, for 203462 and 211010..... | 1 25 |
| 226578 | — | Ruffling Combination No. 40 complete.. | 10 00 |



No. 226362 COMBINATION

(FORMERLY No. 41)

For Shirt Yoke Work. Folds Both Edges of the Yoke and Guides the Body of the Shirt Between Them. The Amount of Fullness May be Varied as Desired.

| No. | Plate | Name | Each |
|---------|-------|---|------|
| 211006 | 11350 | Feed Dog (formerly "26-F") for 211003.. | 75 |
| 226322 | 11510 | Folder (lower) on Shank..... | 1 50 |
| 226323 | 11510 | Folder and Guide (upper) on Shank.... | 2 00 |
| 226324 | 11510 | Folder Plate with four 200169E..... | 1 00 |
| 226325 | 11510 | Folder Plate 226324 with 226322 and 226323 | 4 50 |
| 200169E | 11204 | Folder Plate Screw..... | 04 |
| 200157B | 11204 | Folder Screw..... | 05 |
| 226326 | 11219 | Presser Foot (compound) Hinged, Nos. 200126C, 200178D, 202062, 202994, 203021, 226327 and 226328..... | 2 50 |
| 226327 | 11203 | Presser Foot Auxiliary Ruffling Foot.... | 50 |
| 200126C | 11203 | Presser Foot Auxiliary Ruffling Foot Screw | 02 |
| 226328 | 11203 | Presser Foot Auxiliary Ruffling Foot Spring | 10 |
| 200178D | 11203 | Presser Foot Auxiliary Ruffling Foot Spring Screw..... | 02 |

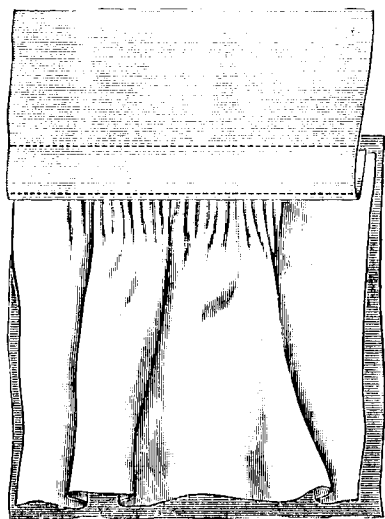
No. 226362 Combination

| No. | Plate | Name | Each |
|---------|-------|--|------|
| 202062 | 11203 | Presser Foot Hinge Pin..... | 01 |
| 203021 | 11203 | Presser Foot Plate..... | 1 15 |
| 202994 | 11203 | Presser Foot Shank..... | 1 00 |
| 226329 | 11202 | Ruffling Blade..... | 35 |
| 226330 | 11202 | Ruffling Blade Clamp..... | 05 |
| 200175 | 11202 | Ruffling Blade Clamp Screw..... | 02 |
| 226331 | 11202 | Ruffling Blade Lever with 226330 and two 200175..... | 2 00 |
| *203340 | 11202 | Ruffling Blade Lever Bracket (adjustable)..... | 25 |
| 226332 | 11216 | Ruffling Blade Lever Bracket (adjustable) 203340 with 200113c, 200289b, 201537, 206042, 226331 and 226334..... | 2 50 |
| 203342 | 11306 | Ruffling Blade Lever Bracket Crank with two each 200098A, 200382c and 202600..... | 75 |
| 200382c | 11305 | Ruffling Blade Lever Bracket Crank Set Screw..... | 02 |
| 200098A | 10438 | Ruffling Blade Lever Bracket Screw..... | 03 |
| 202600 | 11202 | Ruffling Blade Lever Bracket Screw Washer..... | 01 |
| 200289B | 11202 | Ruffling Blade Lever Hinge Screw..... | 05 |
| 201537 | 11202 | Ruffling Blade Lever Hinge Screw Nut.. | 03 |
| 206042 | 11202 | Ruffling Blade Lever Spring..... | 03 |
| 226334 | 11202 | Ruffling Blade Lever Spring Bracket.... | 25 |
| 200113c | 10436 | Ruffling Blade Lever Spring Bracket Screw..... | 03 |
| 226335 | 11201 | Ruffling Blade Lifting Lever..... | 75 |
| 226359 | 11201 | Ruffling Blade Lifting Lever 226335 with 226336 and two 200907b..... | 1 00 |
| 226336 | 11204 | Ruffling Blade Lifting Lever Extension..... | 25 |
| 200907B | 11204 | Ruffling Blade Lifting Lever Extension Screw..... | 02 |
| 200284b | 11204 | Ruffling Blade Lifting Lever Hinge Screw..... | 05 |
| 202104 | 11204 | Ruffling Blade Lifting Lever Hinge Screw Washer..... | 01 |
| 226337 | 11204 | Ruffling Blade Lifting Lever Position Stop..... | 15 |
| 200174b | 11204 | Ruffling Blade Lifting Lever Position Stop Screw..... | 02 |
| 226338 | 11204 | Ruffling Blade Lifting Pin..... | 02 |
| 226339 | 11202 | Ruffling Blade Regulating Lever with two 200382c..... | 1 75 |
| 200382 | 11305 | Ruffling Blade Regulating Lever Set Screw..... | 02 |
| 226341 | 11223 | Ruffling Blade Regulating Lever Shaft.. | 25 |
| 226360 | 11211 | Ruffling Blade Regulating Lever Shaft 226341 with 202574, 203342 and 226332..... | 3 75 |
| 202574 | 11306 | Ruffling Blade Regulating Lever Shaft Collar with 200380c..... | 15 |

No. 226362 Combination

| No. | Plate | Name | Each |
|---------|-------|--|-------|
| 200380c | 11202 | Ruffling Blade Regulating Lever Shaft Collar Set Screw..... | 02 |
| 203343 | 11204 | Ruffling Blade Regulating Lever Slide Stop Block..... | 25 |
| 200092B | 11204 | Ruffling Blade Regulating Lever Slide Stop Block Screw..... | 03 |
| 203349 | 11307 | Ruffling Blade Regulating Lever Slide Stop Block Screw Washer..... | 03 |
| 226345 | 11211 | Switching Lever with 200043c, 200284b, 200907E, 200909E, 226338 and three 200162b..... | 1 60 |
| 226346 | 11211 | Switching Lever 226345 with 202600, 226348 to 226352..... | 3 75 |
| 226357 | --- | Switching Lever 226346 with 226354.... | 4 |
| 226347 | 11203 | Switching Lever Bell Crank..... | 04 |
| 226348 | 11206 | Switching Lever Bell Crank 226347 with 200659c and 201528b..... | 04 |
| 200909E | 11203 | Switching Lever Bell Crank Hinge Screw..... | 03 |
| 226349 | 11203 | Switching Lever Bell Crank Slide Block..... | 04 |
| 200659 | 11203 | Switching Lever Bell Crank Slide Block Screw Stud..... | 04 |
| 201528b | 11203 | Switching Lever Bell Crank Slide Block Screw Stud Nut..... | 04 |
| 202600 | 11202 | Switching Lever Bell Crank Slide Block Screw Stud Washer..... | 04 |
| 226350 | 11201 | Switching Lever Handle..... | 04 |
| 200162b | 11203 | Switching Lever Handle Screw..... | 04 |
| 226351 | 11201 | Switching Lever Latch..... | 04 |
| 200284b | 11204 | Switching Lever Latch Hinge Screw..... | 04 |
| 226352 | 11203 | Switching Lever Latch Spring..... | 04 |
| 200907E | 11204 | Switching Lever Latch Spring Screw.... | 04 |
| 200162b | 11203 | Switching Lever Latch Stop Screw..... | 04 |
| 200043c | 10436 | Switching Lever Pinch Screw..... | 04 |
| 226353 | 11211 | Switching Lever Shaft..... | 35 |
| 226354 | 11211 | Switching Lever Shaft 226353 with 226355 and 226356..... | 1 00 |
| 202305c | 10436 | Switching Lever Shaft Center..... | 06 |
| 200043c | 10436 | Switching Lever Shaft Center Set Screw..... | 04 |
| 226355 | 11211 | Switching Lever Shaft Spring..... | 30 |
| 226355 | 11211 | Switching Lever Shaft Spring Collar with 200363c..... | 25 |
| 200363c | 11204 | Switching Lever Shaft Spring Collar Set Screw..... | 03 |
| 211003 | 11350 | Throat Plate (formerly "21-12-F") 50 hole, for needle sizes 3 to 5, for 203253 and 211006..... | 1 00 |
| 226362 | --- | Ruffling Combination No. 41 complete... | 16 00 |

From the library of Diarrhonesville (2014)



No. 226587 COMBINATION

(FORMERLY No. 42.)

For Making Shirt Yokes. Folds in the Edge of the Outer Yoke, Inserting the Body of the Shirt, Forming the Yoke and Stitching it to the Inside Yoke at One Operation. The Inside Yoke is Then Turned Up So That It Shows Stitching on the Outside Only, the Inside Rows of Stitching Being Covered.

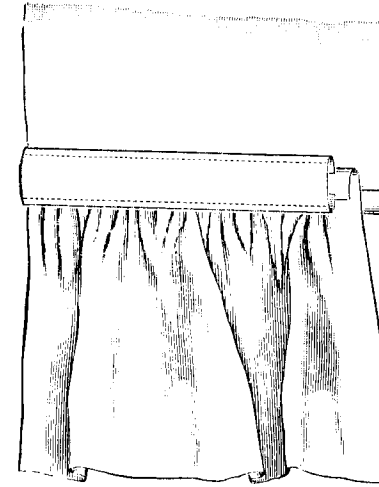
When Ordering, State Gauge Required.

| No. | Plate | Name | Each |
|---------|-------|--|------|
| 211020 | 11354 | Feed Dog for 211019..... | 75 |
| 226579 | 11514 | Folder and Guide (on shank)..... | 4 00 |
| 200157B | 11204 | Folder Screw..... | 05 |
| 226580 | 11514 | Presser Foot Compound Hinged complete, Nos. 200126E, 200178D, 226581, 226582 and 226585..... | 3 00 |
| 226581 | 11514 | Presser Foot Auxiliary Ruffling Foot.... | 75 |
| 200126D | 11203 | Presser Foot Auxiliary Ruffling Foot Screw | 02 |
| 226582 | 11514 | Presser Foot Auxiliary Ruffling Foot Spring | 10 |
| 200178D | 11203 | Presser Foot Auxiliary Ruffling Foot Spring Screw..... | 01 |
| 202090 | 10443 | Presser Foot Hinge Pin..... | 07 |
| *226584 | — | Presser Foot Plate..... | — |
| *226583 | — | Presser Foot Shank..... | — |

| No. | Plate | Name | Each |
|---------|-------|---|------|
| 226585 | 11514 | Presser Foot Shank 226583 with 202090 and 226584..... | 2 25 |
| 226586 | 11514 | Ruffling Blade..... | 50 |
| 226330 | 11202 | Ruffling Blade Clamp..... | 05 |
| 200175 | 11202 | Ruffling Blade Clamp Screw..... | 02 |
| 226331 | 11202 | Ruffling Blade Lever with 226330 and two 200175..... | 2 00 |
| 203340 | 11202 | Ruffling Blade Lever Bracket (adjustable) | 25 |
| 226332 | 11261 | Ruffling Blade Lever Bracket (adjustable) 203340 with 200113c, 200289B, 201537, 206042, 226331 and 226334.... | 2 50 |
| 203342 | 11306 | Ruffling Blade Lever Bracket Crank with two each 200098B, 200382c and 202600.. | 75 |
| 200382c | 11305 | Ruffling Blade Lever Bracket Crank Set Screw | 02 |
| 200098B | 10438 | Ruffling Blade Lever Bracket Screw.... | 03 |
| 202600 | 11202 | Ruffling Blade Lever Bracket Screw Washer | 01 |
| 200289B | 11202 | Ruffling Blade Lever Hinge Screw..... | 05 |
| 201537 | 11202 | Ruffling Blade Lever Hinge Screw Nut.. | 03 |
| 206042 | 11202 | Ruffling Blade Lever Spring..... | 03 |
| 226334 | 11202 | Ruffling Blade Lever Spring Bracket.... | 25 |
| 200113c | 10436 | Ruffling Blade Lever Spring Bracket Screw | 03 |
| 226335 | 11201 | Ruffling Blade Lifting Lever..... | 75 |
| 226359 | 11201 | Ruffling Blade Lifting Lever 226355 with 226336 and two 200907B..... | 1 00 |
| 226336 | 11204 | Ruffling Blade Lifting Lever Extension.. | 25 |
| 200907B | 11204 | Ruffling Blade Lifting Lever Extension Screw | 02 |
| 200284D | 11204 | Ruffling Blade Lifting Lever Hinge Screw | 05 |
| 202104 | 11204 | Ruffling Blade Lifting Lever Hinge Screw Washer | 01 |
| 226337 | 11204 | Ruffling Blade Lifting Lever Position Stop | 15 |
| 200174D | 11204 | Ruffling Blade Lifting Lever Position Stop Screw | 02 |
| 226338 | 11204 | Ruffling Blade Lifting Pin..... | 02 |
| 226339 | 11202 | Ruffling Blade Regulating Lever with two 200382c | 1 75 |
| 200382c | 11305 | Ruffling Blade Regulating Lever Set Screw | 02 |
| 226341 | 11223 | Ruffling Blade Regulating Lever Shaft.. | 25 |
| 226360 | 11211 | Ruffling Blade Regulating Lever Shaft 226341 with 202574, 202342 and 226332.. | 3 75 |
| 202574 | 11306 | Ruffling Blade Regulating Lever Shaft Collar with 200380c..... | 15 |
| 200380c | 11202 | Ruffling Blade Regulating Lever Shaft Collar Set Screw..... | 02 |

From the library of: Diamond Needle Corp

| No. | Plate | Name | Each |
|---------|-------|---|-------|
| 203343 | 11204 | Ruffling Blade Regulating Lever Slide Stop Block..... | 25 |
| 200092B | 11204 | Ruffling Blade Regulating Lever Slide Stop Block Screw..... | 03 |
| 203349 | 11307 | Ruffling Blade Regulating Lever Slide Stop Block Screw Washer..... | 03 |
| 226345 | 11211 | Switching Lever with 200043c, 200284d, 200907E, 200909E, 226338 and three 200162b | 1 60 |
| 226346 | 11211 | Switching Lever 226345 with 202600 and 226348 to 226352..... | 3 75 |
| 226357 | — | Switching Lever 226346 with 226354.... | 4 75 |
| 226347 | 11203 | Switching Lever Bell Crank..... | 50 |
| 226348 | 11206 | Switching Lever Bell Crank 226347 with 200659c and 201528b..... | 60 |
| 200909E | 11203 | Switching Lever Bell Crank Hinge Screw | 08 |
| 226349 | 11203 | Switching Lever Bell Crank Slide Block | 25 |
| 200659c | 11203 | Switching Lever Bell Crank Slide Block Screw Stud..... | 05 |
| 201528b | 11203 | Switching Lever Bell Crank Slide Block Screw Stud Nut..... | 04 |
| 202600 | 11202 | Switching Lever Bell Crank Slide Block Screw Stud Washer..... | 01 |
| 226350 | 11201 | Switching Lever Handle..... | 75 |
| 200162b | 11203 | Switching Lever Handle Screw..... | 04 |
| 226351 | 11201 | Switching Lever Latch..... | 75 |
| 200284d | 11204 | Switching Lever Latch Hinge Screw.... | 05 |
| 226352 | 11203 | Switching Lever Latch Spring..... | 05 |
| 200907E | 11204 | Switching Lever Latch Spring Screw.... | 02 |
| 200162b | 11203 | Switching Lever Latch Stop Screw..... | 04 |
| 200043c | 10436 | Switching Lever Pinch Screw..... | 04 |
| 226353 | 11211 | Switching Lever Shaft..... | 35 |
| 226354 | 11211 | Switching Lever Shaft 226353 with 226355 and 226356..... | 1 00 |
| 202305c | 10436 | Switching Lever Shaft Center..... | 06 |
| 200043c | 10436 | Switching Lever Shaft Center Set Screw | 04 |
| 226355 | 11211 | Switching Lever Shaft Spring..... | 30 |
| 226356 | 11204 | Switching Lever Shaft Spring Collar with 200363c..... | 25 |
| 200363c | 11204 | Switching Lever Shaft Spring Collar Set Screw | 03 |
| 211019 | 11354 | Throat Plate (formerly "29-F") 50 needle hole, for needle sizes 3 to 5, made in gauges from $\frac{1}{4}$ to $\frac{3}{8}$ in. in steps of $\frac{1}{32}$ in., for 203462 and 211020..... | 1 25 |
| 226587 | — | Ruffling Combination No. 42 complete.. | 15 00 |



No. 226590 COMBINATION

(FORMERLY No. 43.)

For Skirt Work. Has Strip Guide, Two Folders and Switching Device. Folds the Edge of the Skirt Up, Folds the Edge of the Ruffle Down and Guides a Strip Over Them.

When Ordering, State Gauge Required.

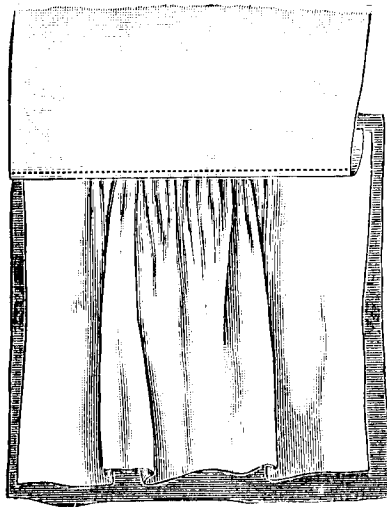
| No. | Plate | Name | Each |
|---------|-------|--|------|
| 226393 | 11214 | Attachment Arm Switch (to the right) with two 200187b..... | 1 25 |
| 226394 | 11214 | Attachment Arm Switch 226393 with 226397 and 226399..... | 2 15 |
| 226395 | 11214 | Attachment Arm Switch Bracket with 200272b, 228032 and two 200911..... | 1 25 |
| 226396 | 11211 | Attachment Arm Switch Bracket 226395 with 226394..... | 3 35 |
| 200272B | 11213 | Attachment Arm Switch Bracket Hinge Screw | 08 |
| 228032 | 11213 | Attachment Arm Switch Bracket Hinge Screw Washer | 01 |
| 200911 | 11213 | Attachment Arm Switch Bracket Screw | 05 |
| 226397 | 11213 | Attachment Arm Switch Latch with 200272b and 226398..... | 85 |
| 200272B | 11213 | Attachment Arm Switch Latch Hinge Screw | 08 |
| 226398 | 11213 | Attachment Arm Switch Latch Hinge Screw Washer..... | 01 |
| 226399 | 11213 | Attachment Arm Switch Latch Spring... | 05 |

From the library of: Diamond Needle Corp

| No. | Plate | Name | Each |
|---------|-------|--|------|
| 211010 | 11355 | Feed Dog (formerly "99") for 211011.... | 60 |
| 226588 | 11515 | Folder and Separating Blade (on shank) | 2 50 |
| 200157B | 11204 | Folder and Separating Blade Screw.... | 05 |
| 226589 | 11516 | Folder (on shank) upper..... | 2 00 |
| 200187B | 11213 | Folder Screw..... | 04 |
| 226542 | 11507 | Presser Foot (strip folder)..... | 2 50 |
| 226506 | 11502 | Ruffling Blade..... | 50 |
| 202610 | 11305 | Ruffling Blade Clamp..... | 02 |
| 200174b | 11204 | Ruffling Blade Clamp Screw..... | 02 |
| 202597 | 11306 | Ruffling Blade Lever with 202610 and two 200174b..... | 1 25 |
| *226403 | --- | Ruffling Blade Lever Bracket (adjust- able) | 25 |
| 226404 | 11213 | Ruffling Blade Lever Bracket (adjust- able) 226403 with 202599b..... | 50 |
| 226415 | 11216 | Ruffling Blade Lever Bracket 226404 with 200289, 201537, 201566b, 202597, 202598 and two 202603..... | 1 85 |
| 226405 | 11213 | Ruffling Blade Lever Bracket Crank with two each 200098b, 202600 and 202602.. | 1 00 |
| 226406 | 11211 | Ruffling Blade Lever Bracket Crank 226405 with 202613 and 226407..... | 2 25 |
| 202602 | 11215 | Ruffling Blade Lever Bracket Crank Position Pin..... | 05 |
| 202613 | 11213 | Ruffling Blade Lever Bracket Crank Spring | 03 |
| 200101b | 11305 | Ruffling Blade Lever Bracket Crank Spring Screw..... | 04 |
| *202973 | --- | Ruffling Blade Lever Bracket Position Collar | — |
| *202974 | --- | Ruffling Blade Lever Bracket Position Collar Position Pin..... | — |
| 200098b | 10438 | Ruffling Blade Lever Bracket Screw.... | 03 |
| 202600 | 11202 | Ruffling Blade Lever Bracket Screw Washer | 01 |
| 226407 | 11215 | Ruffling Blade Lever Bracket Shaft with 200101b, 202973 and 202974..... | 1 25 |
| 226408 | 11211 | Ruffling Blade Lever Bracket Shaft with 226406 and 226415..... | 4 00 |
| 200289 | 11202 | Ruffling Blade Lever Hinge Screw..... | 05 |
| 201537 | 11202 | Ruffling Blade Lever Hinge Screw Nut.. | 03 |
| 202598 | 11305 | Ruffling Blade Lever Spring..... | 05 |
| *200771 | --- | Ruffling Blade Lever Spring Stud..... | — |
| 202599b | 11305 | Ruffling Blade Lever Spring Stud Bracket with 200771..... | 25 |
| 201566b | 11305 | Ruffling Blade Lever Spring Thumb Nut | 05 |
| 202603 | 11305 | Ruffling Blade Lever Spring Thumb Nut Washer | 01 |
| 202603 | 11305 | Ruffling Blade Lever Spring Washer.... | 01 |
| 226409 | 11213 | Stop Block..... | 35 |

| No. | Plate | Name | Each |
|---------|-------|---|-------|
| 226410 | 11211 | Switching Lever with 200043c, 200162, 200284 and 200909e..... | 1 60 |
| 226411 | 11211 | Switching Lever 226410 with 203935, 226412 and 226413..... | 3 00 |
| 226431 | --- | Switching Lever 226411 with 226354.... | 4 00 |
| 226347 | 11203 | Switching Lever Bell Crank..... | 50 |
| 226348 | 11206 | Switching Lever Bell Crank 226347 with 200659c and 201528b..... | 60 |
| 200909e | 11203 | Switching Lever Bell Crank Hinge Screw | 08 |
| 202668 | 11306 | Switching Lever Bell Crank Slide Block | 15 |
| 200659c | 11203 | Switching Lever Bell Crank Slide Block Screw Stud..... | 05 |
| 201528c | 11203 | Switching Lever Bell Crank Slide Block Screw Stud Nut..... | 04 |
| 202104 | 11204 | Switching Lever Bell Crank Slide Block Screw Stud Washer..... | 04 |
| 226413 | 11215 | Switching Lever Latch..... | 50 |
| 200284b | 11204 | Switching Lever Latch Hinge Screw.... | 05 |
| 203935 | 11215 | Switching Lever Latch Spring..... | 02 |
| 202027 | 11215 | Switching Lever Latch Spring Pin..... | 01 |
| 200162b | 11203 | Switching Lever Latch Stop Screw.... | 04 |
| 200043c | 10436 | Switching Lever Pinch Screw..... | 04 |
| 226353 | 11211 | Switching Lever Shaft..... | 25 |
| 226354 | 11211 | Switching Lever Shaft 226353 with 226355 and 226356..... | 00 |
| 202305c | 10436 | Switching Lever Shaft Center..... | 06 |
| 200043c | 10436 | Switching Lever Shaft Center Set Screw | 04 |
| 226355 | 11211 | Switching Lever Shaft Spring..... | 30 |
| 226356 | 11204 | Switching Lever Shaft Spring Collar with 200363c | 25 |
| 200363c | 11204 | Switching Lever Shaft Spring Collar Set Screw | 03 |
| 211011 | 11358 | Throat Plate (formerly "99-F") 50 needle hole, for needle sizes 3 to 5, made in gauges 1, 2, 3, 4 and 5 inch, for 203462 and 211010..... | 1 25 |
| 226590 | --- | Ruffling Combination No. 43 complete... | 16 00 |

From the library of: Diamond Needle Corp



No. 226363 COMBINATION

(FORMERLY No. 44.)

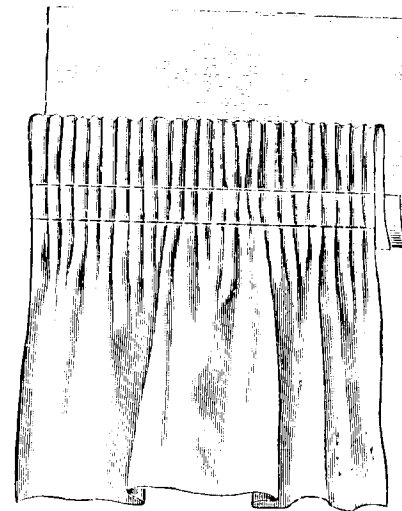
For Shirt Yoke Work. Folds in the Edge of the Outer Yoke Inserting the Body of the Shirt and Stitching it to the Inside At One Operation. The Inside Yoke is Then Turned Up So That It Shows Yoke Stitching on the Outside Only, the Inside Row of Stitching Being Covered.

| No. | Plate | Name | Each |
|---------|-------|--|------|
| 211006 | 11350 | Feed Dog (formerly "26 F") for 211003... | 75 |
| 226361 | 11205 | Folder and Guide (on shank)..... | 4 00 |
| 200157B | 11204 | Folder Screw..... | 05 |
| 226326 | 11219 | Presser Foot (compound) hinged, complete, Nos. 200126c, 202062, 202994, 203021, 226327, 226328 and two 200178D | 2 50 |
| 226327 | 11203 | Presser Foot Auxiliary Ruffling Foot.... | 50 |
| 200126c | 11203 | Presser Foot Auxiliary Ruffling Foot Screw | 02 |
| 226328 | 11203 | Presser Foot Auxiliary Ruffling Foot Spring | 10 |
| 200178D | 11203 | Presser Foot Auxiliary Ruffling Foot Spring Screw..... | 02 |
| 202062 | 11203 | Presser Foot Hinge Pin..... | 01 |
| 203021 | 11203 | Presser Foot Plate..... | 1 15 |
| 202994 | 11203 | Presser Foot Shank..... | 1 00 |
| 226329 | 11202 | Ruffling Blade..... | 35 |
| 226330 | 11202 | Ruffling Blade Clamp..... | 05 |
| 200175 | 11202 | Ruffling Blade Clamp Screw..... | 02 |

| No. | Plate | Name | Each |
|---------|-------|--|------|
| 226331 | 11202 | Ruffling Blade Lever with 226330 and two 200175 | 2 00 |
| *203340 | 11202 | Ruffling Blade Lever Bracket (adjustable) | 25 |
| 226332 | 11216 | Ruffling Blade Lever Bracket (adjustable) 203340 with 200113c, 200289B, 201537, 206042, 226331 and 226334..... | 2 50 |
| 203342 | 11306 | Ruffling Blade Lever Bracket Crank with two each 200098B, 200382c and 202600.. | 75 |
| 200382c | 11305 | Ruffling Blade Lever Bracket Crank Set Screw | 02 |
| 200098B | 10438 | Ruffling Blade Lever Bracket Screw... | 03 |
| 202600 | 11202 | Ruffling Blade Lever Bracket Screw Washer | 01 |
| 200289B | 11202 | Ruffling Blade Lever Hinge Screw..... | 05 |
| 201537 | 11202 | Ruffling Blade Lever Hinge Screw Nut.. | 03 |
| 206042 | 11202 | Ruffling Blade Lever Spring..... | 03 |
| 226334 | 11202 | Ruffling Blade Lever Spring Bracket.... | 25 |
| 200113c | 10436 | Ruffling Blade Lever Spring Bracket Screw | 03 |
| 226335 | 11201 | Ruffling Blade Lifting Lever..... | 01 |
| 226359 | 11201 | Ruffling Blade Lifting Lever 226335 with 226336 and two 200907B..... | 1 00 |
| 226336 | 11204 | Ruffling Blade Lifting Lever Extension.. | 25 |
| 200907B | 11204 | Ruffling Blade Lifting Lever Extension Screw | 02 |
| 200284D | 11201 | Ruffling Blade Lifting Lever Hinge Screw | 05 |
| 202104 | 11204 | Ruffling Blade Lifting Lever Hinge Screw Washer | 01 |
| 226337 | 11204 | Ruffling Blade Lifting Lever Position Stop | 15 |
| 200174D | 11204 | Ruffling Blade Lifting Lever Position Stop Screw | 02 |
| 226338 | 11204 | Ruffling Blade Lifting Pin..... | 02 |
| 226339 | 11202 | Ruffling Blade Regulating Lever with two 200382c | 1 75 |
| 200382c | 11305 | Ruffling Blade Regulating Lever Set Screw | 02 |
| 226341 | 11223 | Ruffling Blade Regulating Lever Shaft, in place of 203345..... | 25 |
| 226360 | 11211 | Ruffling Blade Regulating Lever Shaft 226341 with 202574, 202342 and 226332 | 3 75 |
| 202574 | 11306 | Ruffling Blade Regulating Lever Shaft Collar with 200380c..... | 15 |
| 200380c | 11202 | Ruffling Blade Regulating Lever Shaft Collar Set Screw..... | 02 |
| 203343 | 11204 | Ruffling Blade Regulating Lever Slide Stop Block..... | 25 |
| 200092B | 11204 | Ruffling Blade Regulating Lever Slide Stop Block Screw..... | 03 |

From the library of: 18 months level 03

| No. | Plate | Name | Each |
|---------|-------|---|-------|
| 203349 | 11307 | Ruffling Blade Regulating Lever Slide Stop Block Screw Washer..... | 03 |
| 226345 | 11211 | Switching Lever with 200043c, 200284b, 200907e, 200909e, 226338 and three 200162b | 1 60 |
| 226346 | 11211 | Switching Lever 226345 with 202600 and 226348 to 226352 | 3 75 |
| 226357 | --- | Switching Lever 226346 with 226354..... | 4 75 |
| 226347 | 11203 | Switching Lever Bell Crank..... | 50 |
| 226348 | 11206 | Switching Lever Bell Crank 226347 with 200659c and 201528b..... | 60 |
| 200909e | 11203 | Switching Lever Bell Crank Hinge Screw | 08 |
| 226349 | 11203 | Switching Lever Bell Crank Slide Block | 25 |
| 200659c | 11203 | Switching Lever Bell Crank Slide Block Screw Stud..... | 05 |
| 201528b | 11203 | Switching Lever Bell Crank Slide Block Screw Stud Nut..... | 04 |
| 202600 | 11202 | Switching Lever Bell Crank Slide Block Screw Stud Washer..... | 01 |
| 226350 | 11201 | Switching Lever Handle..... | 75 |
| 200162b | 11203 | Switching Lever Handle Screw..... | 04 |
| 226351 | 11201 | Switching Lever Latch..... | 75 |
| 200284b | 11204 | Switching Lever Latch Hinge Screw.... | 05 |
| 226352 | 11203 | Switching Lever Latch Spring..... | 05 |
| 200907e | 11204 | Switching Lever Latch Spring Screw.... | 02 |
| 200162b | 11203 | Switching Lever Latch Stop Screw.... | 04 |
| 200043c | 10436 | Switching Lever Pinch Screw..... | 04 |
| 226353 | 11211 | Switching Lever Shaft..... | 35 |
| 226354 | 11211 | Switching Lever Shaft 226353 with 226355 and 226356..... | 1 00 |
| 202305e | 10436 | Switching Lever Shaft Center..... | 06 |
| 200043c | 10436 | Switching Lever Shaft Center Set Screw | 01 |
| 226355 | 11211 | Switching Lever Shaft Spring..... | 30 |
| 226356 | 11204 | Switching Lever Shaft Spring Collar with 200363c..... | 25 |
| 200363c | 11204 | Switching Lever Shaft Spring Collar Set Screw | 03 |
| 211003 | 11350 | Throat Plate (formerly "21-12-R") 50 needle hole, for needle sizes 3 to 5, for 203253 and 211006..... | 1 00 |
| 226363 | --- | Ruffling Combination No. 44 complete.... | 14 00 |



No. 226596 COMBINATION

(FORMERLY No. 45.)

For Making Wrappers and Similar Work. It Folds up the Edge of the Material and Folds Down the Ruffle for a Wide Heading.

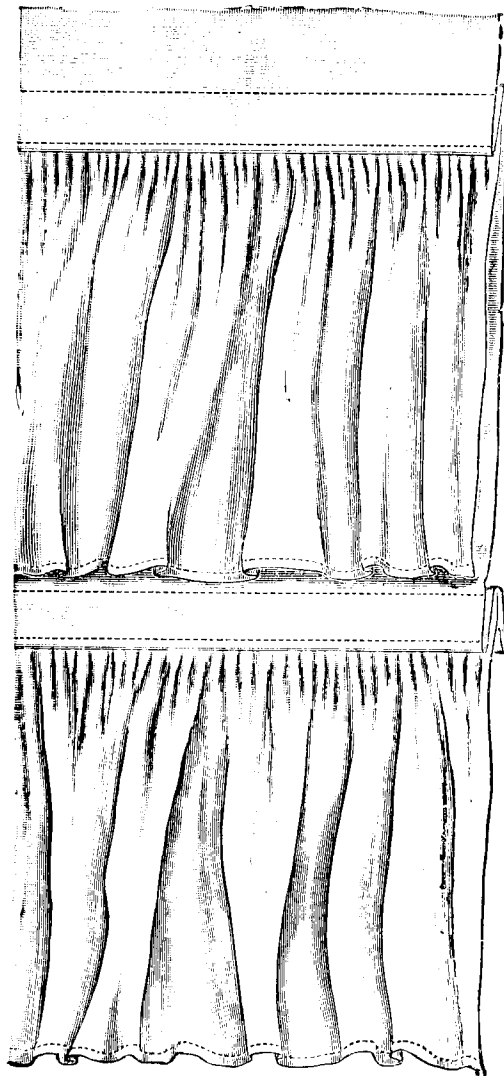
When Ordering, State Gauge Required.

| No. | Plate | Name | Each |
|---------|-------|---|------|
| 226393 | 11214 | Attachment Arm Switch (to the right) with two 200187b..... | 1 50 |
| 226394 | 11214 | Attachment Arm Switch 226393 with 226397 and 226399..... | 2 15 |
| 226591 | 11516 | Attachment Arm Switch Bracket with 200272b, 200566, 200911 and 228032.... | 1 35 |
| 226592 | 11516 | Attachment Arm Switch Bracket 226591 with 226394..... | 3 50 |
| 200272b | 11213 | Attachment Arm Switch Bracket Hinge Screw | 08 |
| 228032 | 11213 | Attachment Arm Switch Bracket Hinge Screw Washer..... | 01 |
| 226397 | 11213 | Attachment Arm Switch Latch with 200272b and 226398..... | 85 |
| 200272b | 11213 | Attachment Arm Switch Latch Hinge Screw | 08 |
| 226398 | 11213 | Attachment Arm Switch Latch Hinge Screw Washer..... | 01 |
| 226399 | 11213 | Attachment Arm Switch Bracket Latch Spring | 05 |

From the library of Diamond Needle Corp

| No. | Plate | Name | Each |
|---------|-------|--|------|
| 200911 | 11213 | Attachment Arm Switch Bracket Screw | 05 |
| 200566 | 11512 | Attachment Arm Switch Bracket Screw | 06 |
| 211010 | 11355 | Feed Dog (formerly "99") for 211011.... | 60 |
| 226593 | 11515 | Folder and Separating Blade (on shank) | 2 75 |
| 200157B | 11204 | Folder and Separating Blade Screw.... | 05 |
| 226594 | 11516 | Folder (on shank) (upper)..... | 2 00 |
| 200187B | 11213 | Folder Screw..... | 04 |
| 203404 | 11303 | Presser Foot..... | 1 00 |
| 226595 | 11515 | Ruffling Blade..... | 50 |
| 202610 | 11305 | Ruffling Blade Clamp..... | 02 |
| 200174D | 11204 | Ruffling Blade Clamp Screw..... | 02 |
| 202597 | 11306 | Ruffling Blade Lever with 202610 and two 200174D..... | 1 25 |
| 226403 | --- | Ruffling Blade Lever Bracket (adjustable) | 25 |
| 226404 | 11213 | Ruffling Blade Lever Bracket (adjust- able) 226403 with 202599B..... | 50 |
| 226415 | 11216 | Ruffling Blade Lever Bracket 226404 with 200289, 201537, 201566B, 202597, 202598 and two 202603..... | 1 85 |
| 226405 | 11213 | Ruffling Blade Lever Bracket Crank with two each 200098B, 202600 and 202602.. | 1 00 |
| 226406 | 11211 | Ruffling Blade Lever Bracket Crank 226405 with 202613 and 226407..... | 2 25 |
| 202602 | 11215 | Ruffling Blade Lever Bracket Crank Posi- tion Pin..... | 05 |
| 202613 | 11213 | Ruffling Blade Lever Bracket Crank Spring..... | 03 |
| 200101D | 11305 | Ruffling Blade Lever Bracket Crank Spring Screw..... | 04 |
| *202973 | --- | Ruffling Blade Lever Bracket Position Collar..... | -- |
| *202974 | --- | Ruffling Blade Lever Bracket Position Collar Position Pin..... | -- |
| 200098B | 10438 | Ruffling Blade Lever Bracket Screw.... | 03 |
| 202600 | 11202 | Ruffling Blade Lever Bracket Screw Washer..... | 01 |
| 226407 | 11215 | Ruffling Blade Lever Bracket Shaft with 200101D, 202973 and 202974..... | 1 25 |
| 226408 | 11211 | Ruffling Blade Lever Bracket Shaft with 226406 and 226115..... | 4 00 |
| 200289 | 11202 | Ruffling Blade Lever Hinge Screw..... | 05 |
| 201537 | 11202 | Ruffling Blade Lever Hinge Screw Nut.. | 03 |
| 202598 | 11305 | Ruffling Blade Lever Spring..... | 05 |
| *200771 | --- | Ruffling Blade Lever Spring Stud..... | -- |
| 202599B | 11305 | Ruffling Blade Lever Spring Stud Bracket with 200771..... | 25 |
| 201566B | 11305 | Ruffling Blade Lever Spring Thumb Nut | 05 |
| 202603 | 11305 | Ruffling Blade Lever Spring Thumb Nut Washer..... | 01 |
| 202603 | 11305 | Ruffling Blade Lever Spring Washer.... | 01 |

| No. | Plate | Name | Each |
|---------|-------|---|-------|
| 226409 | 11213 | Stop Block..... | 35 |
| 226410 | 11211 | Switching Lever with 200043C, 200162, 200284 and 200909C..... | 1 60 |
| 226411 | 11211 | Switching Lever 226410 with 203935, 226412 and 226413..... | 3 00 |
| 226431 | --- | Switching Lever 226411 with 226354.... | 4 00 |
| 226347 | 11203 | Switching Lever Bell Crank..... | 50 |
| 226348 | 11206 | Switching Lever Bell Crank 226347 with 200659C and 201528B..... | 60 |
| 200909C | 11203 | Switching Lever Bell Crank Hinge Screw | 08 |
| 202668 | 11306 | Switching Lever Bell Crank Slide Block | 15 |
| 200659C | 11203 | Switching Lever Bell Crank Slide Block Screw Stud..... | 05 |
| 201528C | 11203 | Switching Lever Bell Crank Slide Block Screw Stud Nut..... | 04 |
| 202104 | 11204 | Switching Lever Bell Crank Slide Block Screw Stud Washer..... | 01 |
| 226413 | 11215 | Switching Lever Latch..... | 50 |
| 200284B | 11204 | Switching Lever Latch Hinge Screw.... | 05 |
| 203935 | 11215 | Switching Lever Latch Spring..... | 02 |
| 202027 | 11215 | Switching Lever Latch Spring Pin..... | 01 |
| 200162D | 11203 | Switching Lever Latch Stop Screw.... | 04 |
| 200043C | 10436 | Switching Lever Pinch Screw..... | 04 |
| 226353 | 11211 | Switching Lever Shaft..... | 35 |
| 226354 | 11211 | Switching Lever Shaft 226353 with 226355 and 226356..... | 1 00 |
| 202305C | 10436 | Switching Lever Shaft Center..... | 06 |
| 200043C | 10436 | Switching Lever Shaft Center Set Screw | 04 |
| 226355 | 11211 | Switching Lever Shaft Spring..... | 30 |
| 226356 | 11204 | Switching Lever Shaft Spring Collar with 200363C..... | 25 |
| 200363C | 11204 | Switching Lever Shaft Spring Collar Set Screw..... | 03 |
| 211011 | 11358 | Throat Plate (formerly "99-F") 50 needle hole, for needle sizes 3 to 5, made in gauges 1, $\frac{3}{8}$, $\frac{1}{2}$, $\frac{5}{8}$ and $\frac{3}{4}$ inch, for 203462 and 211010..... | 1 25 |
| 226596 | --- | Ruffling Combination No. 45 complete... | 14 00 |



Specimen of Work Done on 226599 Combination.

No. 226599 COMBINATION

(FORMERLY No. 47.)

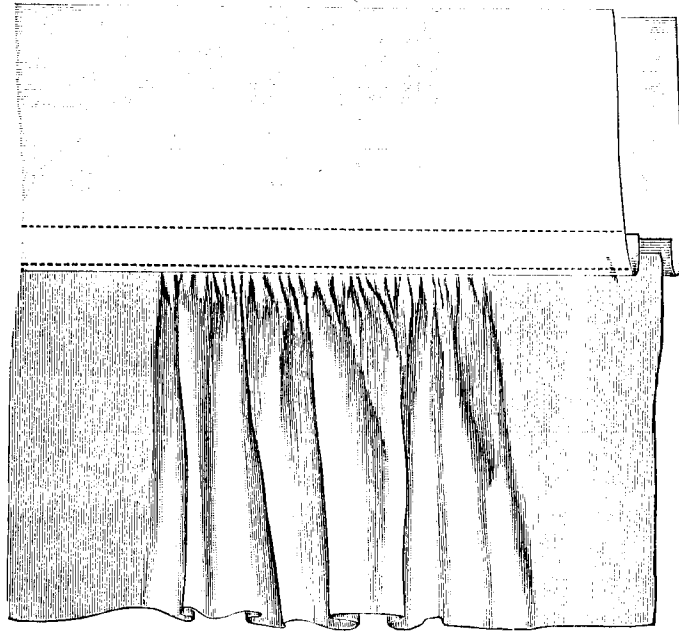
Produces Work Similar to That Done with Combination No. 33.
This Combination Has Shorter Guides, Having Greater
Clearance for Seams to Pass Through and is Better
Adapted for Circular or Tubular Work than No. 33.

When Ordering, State Gauge Required.

| No. | Plate | Name | Each |
|---------|-------|--|------|
| 226393 | 11214 | Attachment Arm Switch (to the right) with two 200187b..... | 1 25 |
| 226394 | 11214 | Attachment Arm Switch 226393 with 226397 and 226399..... | 2 15 |
| 226432 | 11214 | Attachment Arm Switch Bracket with 200272b, 228032 and two 200911..... | 1 25 |
| 200911 | 11213 | Attachment Arm Switch Bracket Screw | 25 |
| 226433 | 11214 | Attachment Arm Switch Bracket 226432 and 226394..... | 3 25 |
| 200272b | 11213 | Attachment Arm Switch Hinge Screw... | 25 |
| 228032 | 11213 | Attachment Arm Switch Hinge Screw Washer | 25 |
| 226397 | 11213 | Attachment Arm Switch Latch with 200272b and 226398..... | 25 |
| 200272b | 11213 | Attachment Arm Switch Latch Hinge Screw | 25 |
| 228032 | 11213 | Attachment Arm Switch Latch Hinge Screw Washer..... | 25 |
| 226399 | 11213 | Attachment Arm Switch Latch Spring.. | 05 |
| 226416 | 11217 | Bed Switch with two 200173..... | 60 |
| 226598 | 11516 | Bed Switch Folder (plate) 226419 with 226416, 226421 and 226597..... | 3 75 |
| 226597 | 11517 | Bed Switch Guide (on shank)..... | 75 |
| 200173 | 11215 | Bed Switch Guide Screw..... | 04 |
| 200305 | 11204 | Bed Switch Hinge Screw..... | 04 |
| 226419 | 11217 | Bed Switch Locking Plate with two 200173 | 75 |
| 226421 | 11217 | Bed Switch Locking Plate Hemmer (on shank) | 1 50 |
| 200157b | 11204 | Bed Switch Locking Plate Hemmer Screw | 04 |
| 200157b | 11204 | Bed Switch Locking Plate Screw..... | 05 |
| 211030 | 11356 | Feed Dog (formerly "134") for 211028 and 211029 | 75 |

| No. | Plate | Name | Each |
|---------|-------|---|------|
| 226422 | 11215 | Guide and Separating Blade (on shank) | 1 00 |
| 226423 | 11215 | Guide and Separating Blade Bracket (intermediate) with two 200173..... | 60 |
| 226424 | 11212 | Guide and Separating Blade Bracket 226423 with 226422..... | 1 60 |
| 200187 | 11213 | Guide and Separating Blade Bracket Screw | 04 |
| 200173 | 11215 | Guide and Separating Blade Screw..... | 04 |
| 202090 | 10443 | Presser Foot Hinge Pin..... | 01 |
| 226565 | — | Presser Foot Plate..... | 1 25 |
| 226566 | 11512 | Presser Foot Plate Spring..... | 25 |
| 200174D | 11204 | Presser Foot Plate Spring Screw..... | 02 |
| 202932 | — | Presser Foot Shank..... | 75 |
| 226567 | 11512 | Presser Foot complete, Nos. 200174D, 202090, 202932, 226465 and 226566..... | 2 25 |
| 226568 | 11512 | Ruffling Blade..... | 50 |
| 202610 | 11305 | Ruffling Blade Clamp..... | 02 |
| 200174D | 11204 | Ruffling Blade Clamp Screw..... | 02 |
| 202597 | 11306 | Ruffling Blade Lever with 202610 and two 200174D..... | 1 25 |
| 202837 | 11218 | Ruffling Blade Lever Bracket with 202599B and two 202602..... | 1 75 |
| 202602 | 11215 | Ruffling Blade Lever Bracket Pin..... | 05 |
| *202973 | — | Ruffling Blade Lever Bracket Position Collar | — |
| *202974 | — | Ruffling Blade Lever Bracket Position Collar Position Pin..... | — |
| 226407 | 11215 | Ruffling Blade Lever Bracket Shaft with 200101D, 202973 and 202974..... | 1 25 |
| 226429 | 11211 | Ruffling Blade Lever Bracket Shaft 226407 with 200289B, 201537, 201566B, 202597, 202598, 202613, 202837 and two 202603..... | 4 75 |
| 202613 | 11213 | Ruffling Blade Lever Bracket Spring.... | 02 |
| 200101B | 11305 | Ruffling Blade Lever Bracket Screw.... | 04 |
| 200289B | 11202 | Ruffling Blade Lever Hinge Screw..... | 05 |
| 201537 | 11202 | Ruffling Blade Lever Hinge Screw Nut.. | 02 |
| 202598 | 11305 | Ruffling Blade Lever Spring..... | 05 |
| *200771 | — | Ruffling Blade Lever Spring Stud..... | — |
| 202599B | 11305 | Ruffling Blade Lever Spring Stud Bracket with 200771..... | 25 |
| 201566B | 11305 | Ruffling Blade Lever Spring Thumb Nut | 05 |
| 202603 | 11305 | Ruffling Blade Lever Spring Thumb Nut Washer | 01 |
| 202603 | 11305 | Ruffling Blade Lever Spring Washer.... | 01 |
| 226410 | 11211 | Switching Lever with 200043c, 200162, 200284 and 200909E..... | 1 60 |
| 226411 | 11211 | Switching Lever 226410 with 203935, 226348 and 226413..... | 3 00 |
| 226431 | — | Switching Lever 226411 with 226354..... | 4 0 |

| No. | Plate | Name | Each |
|---------|-------|--|-------|
| 226347 | 11203 | Switching Lever Bell Crank..... | 50 |
| 226348 | 11206 | Switching Lever Bell Crank 226347 with 200659c and 201528c..... | 60 |
| 200909E | 11203 | Switching Lever Bell Crank Hinge Screw | 08 |
| 202668 | 11306 | Switching Lever Bell Crank Slide Block | 15 |
| 200659c | 11203 | Switching Lever Bell Crank Slide Block Screw Stud..... | 05 |
| 201528c | 11203 | Switching Lever Bell Crank Slide Block Screw Stud Nut..... | 04 |
| 202104 | 11204 | Switching Lever Bell Crank Slide Block Screw Stud Washer..... | 01 |
| 226413 | 11215 | Switching Lever Latch..... | 50 |
| 200284B | 11204 | Switching Lever Latch Hinge Screw.... | 05 |
| 203935 | 11215 | Switching Lever Latch Spring..... | 02 |
| 202027 | 11215 | Switching Lever Latch Spring Pin.... | 01 |
| 200162 | 11203 | Switching Lever Latch Stop Screw..... | 04 |
| 200043c | 10436 | Switching Lever Pinch Screw..... | 04 |
| 226353 | 11211 | Switching Lever Shaft..... | 35 |
| 226354 | 11211 | Switching Lever Shaft 226353 with 226355 and 226356..... | 1 00 |
| 202305c | 10436 | Switching Lever Shaft Center..... | 06 |
| 200043c | 10436 | Switching Lever Shaft Center Set Screw | 04 |
| 226355 | 11211 | Switching Lever Shaft Spring..... | 30 |
| 226356 | 11204 | Switching Lever Shaft Spring Collar with 200363c | 25 |
| 200363c | 11204 | Switching Lever Shaft Spring Collar Set Screw | 03 |
| 211028 | 11356 | Throat Plate (formerly "134") 50 needle hole, for needle sizes 3 to 5, made in gauges $\frac{1}{8}$, $\frac{3}{16}$, $\frac{1}{4}$, $\frac{5}{16}$, $\frac{3}{8}$, $\frac{1}{2}$ and $\frac{5}{8}$ inch, for 203462 and 211030..... | 1 25 |
| 211029 | 11356 | Throat Plate (formerly "134") 46 needle hole, for needle sizes 5 to 7, made in gauges $\frac{1}{8}$, $\frac{3}{16}$, $\frac{1}{4}$, $\frac{5}{16}$, $\frac{3}{8}$, $\frac{1}{2}$ and $\frac{5}{8}$ inch, for 203462 and 211030..... | 1 25 |
| 226599 | — | Ruffling Combination No. 47 complete.. | 18 50 |



No. 226603 COMBINATION

(FORMERLY No. 48.)

For Making Shirt Yokes in a Manner Similar to Combination No.

41, But Using Two Needles Instead of One.

When Ordering, State Gauge Required.

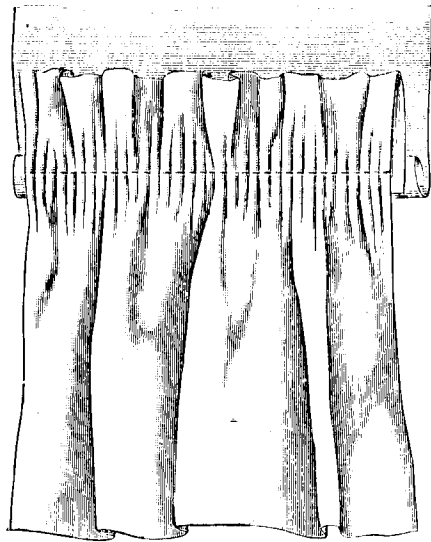
| No. | Plate | Name | Each |
|---------|-------|---|------|
| 211020 | 11354 | Feed Dog for 211019..... | 75 |
| 226600 | 11517 | Folder (lower) on shank..... | 1 50 |
| 226601 | 11517 | Folder and Guide (upper) on shank..... | 2 50 |
| 226579 | 11514 | Folder and Guide (on shank)..... | 4 06 |
| 200173 | 11215 | Folder and Guide Screw..... | 01 |
| 226324 | 11510 | Folder Plate with four 200173..... | 1 00 |
| 226602 | 11518 | Folder Plate 226324 with 226600 and 226601 | 4 00 |
| 200157B | 11204 | Folder Plate Screw..... | 05 |
| 226581 | 11514 | Presser Foot Auxiliary Ruffling Foot.... | 75 |
| 200126c | 11203 | Presser Foot Auxiliary Ruffling Foot Screw | 01 |

| No. | Plate | Name | Each |
|---------|-------|---|------|
| 226582 | 11514 | Presser Foot Auxiliary Ruffling Foot Spring | 10 |
| 200178D | 11203 | Presser Foot Auxiliary Ruffling Foot Spring Screw..... | 02 |
| 202090 | 10413 | Presser Foot Hinge Pin..... | 01 |
| *226584 | — | Presser Foot Plate..... | 1 25 |
| *226583 | — | Presser Foot Shank..... | 1 00 |
| 226585 | 11514 | Presser Foot Shank 226583 with 202090 and 226584..... | 2 25 |
| 226580 | 11514 | Presser Foot Compound Hinged complete, Nos. 200126c, 200178D, 226581, 226582 and 226585..... | 3 00 |
| 226586 | 11514 | Ruffling Blade..... | 50 |
| 226330 | 11202 | Ruffling Blade Clamp..... | 05 |
| 200175 | 11202 | Ruffling Blade Clamp Screw..... | 02 |
| 226331 | 11202 | Ruffling Blade Lever with 226330 and two 200175 | 2 00 |
| *203340 | 11202 | Ruffling Blade Lever Bracket (adjust- able) | 25 |
| 226332 | 11216 | Ruffling Blade Lever Bracket (adjust- able) 203340 with 200113c, 200289B, 201537, 206042, 226331 and 226334.... | 2 50 |
| 203342 | 11306 | Ruffling Blade Lever Bracket Crank with two each 200098B, 200382c and 202600.. | 75 |
| 200382c | 11305 | Ruffling Blade Lever Bracket Crank Set Screw | 02 |
| 200098B | 10438 | Ruffling Blade Lever Bracket Screw.... | 03 |
| 202600 | 11202 | Ruffling Blade Lever Bracket Screw Washer | 01 |
| 200289B | 11202 | Ruffling Blade Lever Hinge Screw..... | 05 |
| 201537 | 11202 | Ruffling Blade Lever Hinge Screw Nut.. | 03 |
| 206042 | 11202 | Ruffling Blade Lever Spring..... | 03 |
| 226334 | 11202 | Ruffling Blade Lever Spring Bracket.... | 25 |
| 200113c | 10436 | Ruffling Blade Lever Spring Bracket Screw | 03 |
| 226335 | 11201 | Ruffling Blade Lifting Lever..... | 75 |
| 226359 | 11201 | Ruffling Blade Lifting Lever 226355 with 226336 and two 200907B..... | 1 00 |
| 226336 | 11204 | Ruffling Blade Lifting Lever Extension.. | 25 |
| 200907B | 11204 | Ruffling Blade Lifting Lever Extension Screw | 02 |
| 200284D | 11204 | Ruffling Blade Lifting Lever Hinge Screw | 05 |
| 202104 | 11204 | Ruffling Blade Lifting Lever Hinge Screw Washer | 01 |
| 226337 | 11204 | Ruffling Blade Lifting Lever Position Stop | 15 |
| 200174D | 11204 | Ruffling Blade Lifting Lever Position Stop Screw..... | 02 |
| 226338 | 11204 | Ruffling Blade Lifting Pin..... | 02 |

From the library of: Diamond Needle Corp.

| No. | Plate | Name | Each |
|---------|-------|---|------|
| 226339 | 11202 | Ruffling Blade Regulating Lever with two 200382c, in place of 202607..... | 1 75 |
| 200382c | 11305 | Ruffling Blade Regulating Lever Set Screw | 02 |
| 226341 | 11223 | Ruffling Blade Regulating Lever Shaft, in place of 203345..... | 25 |
| 226360 | 11211 | Ruffling Blade Regulating Lever Shaft 226341 with 202574, 202342 and 226332.. | 3 75 |
| 202574 | 11306 | Ruffling Blade Regulating Lever Shaft Collar with 200380c..... | 15 |
| 200380c | 11202 | Ruffling Blade Regulating Lever Shaft Collar Set Screw..... | 02 |
| 203343 | 11204 | Ruffling Blade Regulating Lever Slide Stop Block..... | 25 |
| 200092b | 11204 | Ruffling Blade Regulating Lever Slide Stop Block Screw..... | 03 |
| 203349 | 11307 | Ruffling Blade Regulating Lever Slide Stop Block Screw Washer..... | 03 |
| 226345 | 11211 | Switching Lever with 200043c, 200284d, 200907e, 200909e, 226338 and three 200162d | 1 60 |
| 226346 | 11211 | Switching Lever 226345 with 202600 and 226348 to 226352..... | 3 75 |
| 226357 | — | Switching Lever 226346 with 226354..... | 4 75 |
| 226347 | 11203 | Switching Lever Bell Crank | 50 |
| 226348 | 11206 | Switching Lever Bell Crank 226317 with 200659c and 201528d..... | 60 |
| 200909e | 11203 | Switching Lever Bell Crank Hinge Screw | 08 |
| 226349 | 11203 | Switching Lever Bell Crank Slide Block | 25 |
| 200659c | 11203 | Switching Lever Bell Crank Slide Block Screw Stud..... | 05 |
| 201528d | 11203 | Switching Lever Bell Crank Slide Block Screw Stud Nut..... | 04 |
| 202600 | 11202 | Switching Lever Bell Crank Slide Block Screw Stud Washer..... | 01 |
| 226350 | 11201 | Switching Lever Handle..... | 75 |
| 200162d | 11203 | Switching Lever Handle Screw..... | 04 |
| 226351 | 11201 | Switching Lever Latch..... | 75 |
| 200284d | 11204 | Switching Lever Latch Hinge Screw.... | 05 |
| 226352 | 11203 | Switching Lever Latch Spring..... | 05 |
| 200907e | 11204 | Switching Lever Latch Spring Screw.... | 02 |
| 200162d | 11203 | Switching Lever Latch Stop Screw.... | 04 |
| 200043c | 10436 | Switching Lever Pinch Screw..... | 04 |
| 226353 | 11211 | Switching Lever Shaft..... | 35 |
| 226354 | 11211 | Switching Lever Shaft 226353 with 226355 and 226356..... | 1 00 |

| No. | Plate | Name | Each |
|---------|-------|---|-------|
| 202305c | 10436 | Switching Lever Shaft Center..... | 06 |
| 200043c | 10436 | Switching Lever Shaft Center Set Screw | 04 |
| 226355 | 11211 | Switching Lever Shaft Spring..... | 30 |
| 226356 | 11204 | Switching Lever Shaft Spring Collar with 200363c | 25 |
| 200363c | 11204 | Switching Lever Shaft Collar Set Screw | 03 |
| 211019 | 11351 | Throat Plate (formerly "29-F") 50 needle hole, for needle sizes 3 to 5, made in gauges from $\frac{3}{16}$ in. to $\frac{5}{16}$ in. in steps of $\frac{1}{16}$ in., for 203462 and 211020..... | 1 25 |
| 226603 | — | Ruffling Combination No. 48 complete... | 15 00 |



No. 226414 COMBINATION

(FORMERLY No. 50)

FOR WRAPPER WORK

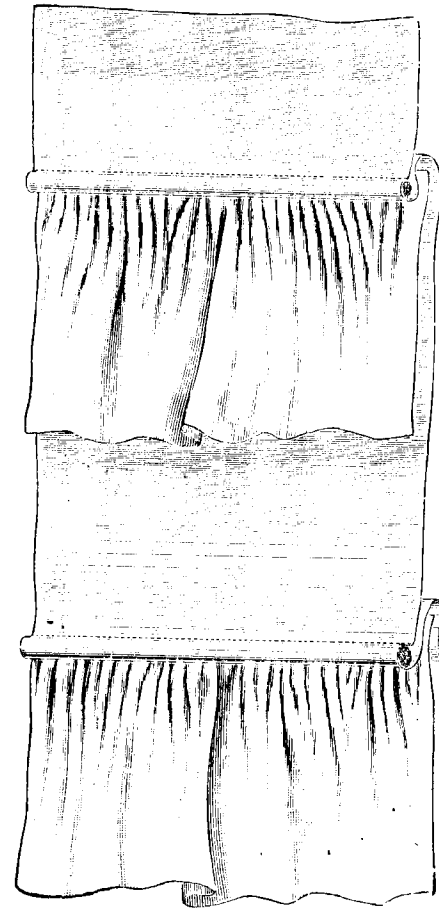
Folds Up the Edge of the Material and Folds Down the Ruffle for a Wide Heading.

| No. | Plate | Name | Each |
|---------|-------|--|------|
| 226393 | 11214 | Attachment Arm Switch (to the right) with two 200187B..... | 1 25 |
| 226394 | 11214 | Attachment Arm Switch with 226393, 226397 and 226399..... | 2 15 |
| 226395 | 11214 | Attachment Arm Switch Bracket with 200272B, 228032 and two 200911..... | 1 25 |
| 226396 | 11211 | Attachment Arm Switch Bracket 226395 with 226394..... | 3 35 |
| 200911 | 11213 | Attachment Arm Switch Bracket Screw.. | 05 |
| 200272B | 11213 | Attachment Arm Switch Hinge Screw... | 08 |
| 228032 | 11213 | Attachment Arm Switch Hinge Screw Washer | 01 |
| 226397 | 11213 | Attachment Arm Switch Latch with 200272B and 226398..... | 85 |
| 200272B | 11213 | Attachment Arm Switch Latch Hinge Screw | 08 |
| 226398 | 11213 | Attachment Arm Switch Latch Hinge Screw Washer | 01 |

| No. | Plate | Name | Each |
|---------|-------|---|------|
| 226399 | 11213 | Attachment Arm Switch Latch Spring.. | 05 |
| 211002 | 11350 | Feed Dog (formerly "123") for 211001... | 75 |
| 226400 | 11212 | Folder (on shank)..... | 2 00 |
| 200187B | 11213 | Folder Screw..... | 04 |
| 226402 | 11213 | Hemmer and Separating Blade on Shank, Hems the under material for a finished heading. The Combination produces a ruffle stitched to a single piece of material with two finished headings | 2 50 |
| 200157B | 11204 | Hemmer and Separating Blade Screw... | 05 |
| 203330 | 11303 | Presser Foot..... | 85 |
| 226366 | 11209 | Ruffling Blade..... | 35 |
| 202610 | 11305 | Ruffling Blade Clamp..... | 02 |
| 200171D | 11204 | Ruffling Blade Clamp Screw..... | 02 |
| 202597 | 11306 | Ruffling Blade Lever with 202610 and two 200194b..... | 25 |
| *226403 | --- | Ruffling Blade Lever Bracket (adjustable) | 25 |
| 226404 | 11213 | Ruffling Blade Lever Bracket (adjustable) 226403 with 202599B..... | 50 |
| 226415 | 11216 | Ruffling Blade Lever Bracket 226404 with 200289, 201537, 201566B, 202597, 202598 and two 202603..... | 85 |
| 226405 | 11213 | Ruffling Blade Lever Bracket Crank with two each 200098A, 202600 and 202602.. | 1 00 |
| 226406 | 11211 | Ruffling Blade Lever Bracket Crank 226405 with 202613 and 226407..... | 2 25 |
| 202602 | 11215 | Ruffling Blade Lever Bracket Crank Position Pin..... | 05 |
| 202613 | 11213 | Ruffling Blade Lever Bracket Crank Spring | 03 |
| 200101D | 11305 | Ruffling Blade Lever Bracket Crank Spring Screw..... | 04 |
| *202973 | --- | Ruffling Blade Lever Bracket Position Collar | --- |
| *202974 | --- | Ruffling Blade Lever Bracket Position Collar Position Pin..... | --- |
| 200098A | 10438 | Ruffling Blade Lever Bracket Screw.... | 03 |
| 202600 | 11202 | Ruffling Blade Lever Bracket Screw Washer | 01 |
| 226407 | 11215 | Ruffling Blade Lever Bracket Shaft with 200101b, 202973 and 202974..... | 1 25 |
| 226408 | 11211 | Ruffling Blade Lever Bracket Shaft with 226406 and 226415..... | 4 00 |
| 200289 | 11202 | Ruffling Blade Lever Hinge Screw..... | 05 |
| 201537 | 11202 | Ruffling Blade Lever Hinge Screw Nut.. | 03 |
| 202598 | 11305 | Ruffling Blade Lever Spring..... | 05 |

From the Library of Diamond Needs Corp

| No. | Plate | Name | Each |
|---------|-------|---|-------|
| *200771 | --- | Ruffling Blade Lever Spring Stud..... | — |
| 202599B | 11305 | Ruffling Blade Lever Spring Stud Bracket with 200771..... | 25 |
| 201566B | 11305 | Ruffling Blade Lever Spring Thumb Nut | 05 |
| 202603 | 11305 | Ruffling Blade Lever Spring Thumb Nut Washer | 01 |
| 202603 | 11305 | Ruffling Blade Lever Spring Washer.... | 01 |
| 226409 | 11213 | Stop Block..... | 35 |
| 226410 | 11211 | Switching Lever with 200043c, 200162, 200284 and 200909c..... | 1 60 |
| 226411 | 11211 | Switching Lever 226410 with 203935, 226348 and 226413..... | 3 00 |
| 226431 | --- | Switching Lever 226411 with 226354.... | 4 00 |
| 226347 | 11203 | Switching Lever Bell Crank | 50 |
| 226348 | 11206 | Switching Lever Bell Crank 226347 with 200659c and 201528b..... | 60 |
| 200909E | 11203 | Switching Lever Bell Crank Hinge Screw | 08 |
| 202668 | 11306 | Switching Lever Bell Crank Slide Block | 15 |
| 200659c | 11203 | Switching Lever Bell Crank Slide Block Screw Stud..... | 05 |
| 201528 | 11203 | Switching Lever Bell Crank Slide Block Screw Stud Nut..... | 04 |
| 202104 | 11204 | Switching Lever Bell Crank Slide Block Screw Stud Washer..... | 01 |
| 226413 | 11215 | Switching Lever Latch..... | 50 |
| 200284B | 11204 | Switching Lever Latch Hinge Screw.... | 05 |
| 203935 | 11215 | Switching Lever Latch Spring | 02 |
| 202027 | 11215 | Switching Lever Latch Spring Pin..... | 01 |
| 200162B | 11203 | Switching Lever Latch Stop Screw..... | 01 |
| 200043c | 10436 | Switching Lever Pinch Screw..... | 04 |
| 226353 | 11211 | Switching Lever Shaft..... | 35 |
| 226354 | 11211 | Switching Lever Shaft 226353 with 226355 and 226356..... | 1 00 |
| 202305c | 10436 | Switching Lever Shaft Center..... | 06 |
| 200043c | 10436 | Switching Lever Shaft Center Set Screw | 04 |
| 226355 | 11211 | Switching Lever Shaft Spring..... | 30 |
| 226356 | 11204 | Switching Lever Shaft Spring Collar with 200363c | 25 |
| 200363c | 11204 | Switching Lever Shaft Spring Collar Set Screw | 03 |
| 211001 | 11350 | Throat Plate (formerly "123-F") 50 needle hole, for needle sizes 3 to 5, for 203253 and 211002..... | 1 00 |
| 226414 | --- | Ruffling Combination No. 50 complete... | 14 00 |



No. 226430 COMBINATION

(FORMERLY NO. 51)

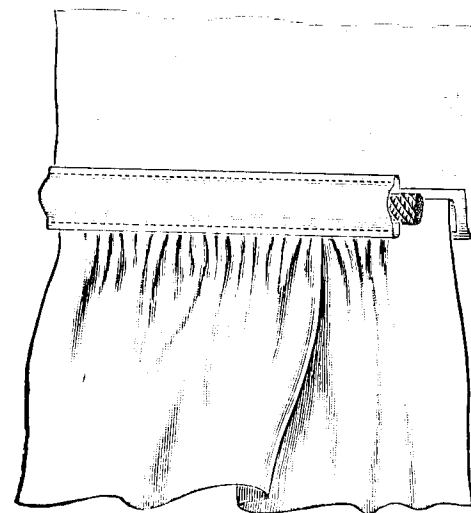
For Skirt and Petticoat Manufacturing. Folds the Edge of the Material and Guides the Strip Between the Folds and Ruffles It. It also Lays a Cord in the Upper Fold. It Has a Switching Device for Throwing the Ruffler and the Folders Out of Action to Finish.

| No. | Plate | Name | Each |
|--------|-------|---|---------|
| 226393 | 11214 | Attachment Arm Switch (to the right) with two 200187B..... | \$ 1 25 |
| 226394 | 11214 | Attachment Arm Switch 226393 with 226397 and 226399..... | 2 15 |

| No. | Plate | Name | Each |
|---------|-------|--|------|
| 226432 | 11214 | Attachment Arm Switch Bracket with 200272B, 228032 and two 200911..... | 1 25 |
| 226433 | 11211 | Attachment Arm Switch Bracket 226432 with 226394..... | 3 35 |
| 200911 | 11213 | Attachment Arm Switch Bracket Screw | 05 |
| 200272B | 11213 | Attachment Arm Switch Hinge Screw.... | 08 |
| 228032 | 11213 | Attachment Arm Switch Hinge Screw Washer | 01 |
| 226397 | 11213 | Attachment Arm Switch Latch with 200272B and 226398..... | 85 |
| 200272B | 11213 | Attachment Arm Switch Latch Hinge Screw | 08 |
| 226398 | 11213 | Attachment Arm Switch Latch Hinge Screw Washer..... | 01 |
| 226399 | 11213 | Attachment Arm Switch Latch Spring.. | 05 |
| 226416 | 11217 | Bed Switch with two 200173..... | 60 |
| 226418 | 11217 | Bed Switch Cord Guide (on shank).... | 1 25 |
| 200173 | 11215 | Bed Switch Cord Guide Screw..... | 04 |
| 200305 | 11204 | Bed Switch Hinge Screw..... | 04 |
| 226419 | 11217 | Bed Switch Locking Plate with two 200173 | 75 |
| 226420 | 11201 | Bed Switch Locking Plate 226419 with 226416, 226418 and 226421..... | 4 00 |
| 226421 | 11217 | Bed Switch Locking Plate Hemmer (on shank) | 1 50 |
| 200173 | 11215 | Bed Switch Locking Plate Hemmer Screw | 04 |
| 200157B | 11204 | Bed Plate Locking Plate Screw..... | 05 |
| 211045 | 11354 | Feed Dog for 211004..... | 75 |
| 226422 | 11215 | Guide and Separating Blade (on shank) | 1 00 |
| 226423 | 11215 | Guide and Separating Blade Bracket (intermediate) with two 200173..... | 60 |
| 226424 | 11212 | Guide and Separating Blade Bracket 226423 with 226422..... | 1 60 |
| 200187 | 11213 | Guide and Separating Blade Bracket Screw | 04 |
| 200173 | 11215 | Guide and Separating Blade Screw..... | 04 |
| 226426 | 11218 | Presser Foot..... | 1 00 |
| 226427 | 11218 | Ruffling Blade..... | 35 |
| 202610 | 11305 | Ruffling Blade Clamp..... | 02 |
| 200174B | 11204 | Ruffling Blade Clamp Screw..... | 02 |
| 202597 | 11306 | Ruffling Blade Lever with 202610 and two 200174B | 1 25 |
| 202837 | 11218 | Ruffling Blade Lever Bracket with 202599B and two 202602..... | 1 75 |
| 202602 | 11215 | Ruffling Blade Lever Bracket Pin..... | 05 |
| *202973 | — | Ruffling Blade Lever Bracket Position Collar | — |

| No. | Plate | Name | Each |
|---------|-------|--|------|
| *202974 | — | Ruffling Blade Lever Bracket Position Collar Position Pin..... | — |
| 226407 | 11215 | Ruffling Blade Lever Bracket Shaft with 200101B, 202973 and 202974..... | 1 25 |
| 226429 | 11211 | Ruffling Blade Lever Bracket Shaft 226407 with 200289B, 201537, 201566B, 202597, 202598, 202613, 202837 and two 202603 | 4 75 |
| 202613 | 11213 | Ruffling Blade Lever Bracket Spring.... | 03 |
| 200101B | 11305 | Ruffling Blade Lever Bracket Spring Screw | 04 |
| 200289B | 11202 | Ruffling Blade Lever Hinge Screw..... | 05 |
| 201537 | 11202 | Ruffling Blade Lever Hinge Screw Nut.. | 03 |
| 202598 | 11305 | Ruffling Blade Lever Spring..... | 05 |
| *200771 | — | Ruffling Blade Lever Spring Stud..... | — |
| 202599B | 11305 | Ruffling Blade Lever Spring Stud Bracket with 200771..... | 1 50 |
| 201566B | 11305 | Ruffling Blade Lever Spring Thumb Nut | 05 |
| 202603 | 11305 | Ruffling Blade Lever Spring Thumb Nut Washer | 04 |
| 202603 | 11305 | Ruffling Blade Lever Spring Washer.... | 04 |
| 226410 | 11211 | Switching Lever with 200043C, 200162, 200284 and 200909E..... | 1 60 |
| 226411 | 11211 | Switching Lever 226410 with 203935, 226348 and 226413..... | 3 60 |
| 226431 | — | Switching Lever 226411 with 226354..... | 4 60 |
| 226347 | 11203 | Switching Lever Bell Crank..... | — |
| 226348 | 11206 | Switching Lever Bell Crank 226347 with 200659C and 201528C..... | 60 |
| 200909E | 11203 | Switching Lever Bell Crank Hinge Screw | 08 |
| 202668 | 11306 | Switching Lever Bell Crank Slide Block | 05 |
| 200659C | 11203 | Switching Lever Bell Crank Slide Block Screw Stud..... | 05 |
| 201528C | 11203 | Switching Lever Bell Crank Slide Block Screw Stud Nut..... | 04 |
| 202104 | 11204 | Switching Lever Bell Crank Slide Block Screw Stud Washer..... | 01 |
| 226413 | 11215 | Switching Lever Latch..... | 50 |
| 200284B | 11204 | Switching Lever Latch Hinge Screw.... | 05 |
| 203935 | 11215 | Switching Lever Latch Spring..... | 02 |
| 202027 | 11215 | Switching Lever Latch Spring Pin..... | 01 |
| 200162 | 11203 | Switching Lever Latch Stop Screw..... | 04 |
| 200043C | 10436 | Switching Lever Pinch Screw..... | 04 |
| 226353 | 11211 | Switching Lever Shaft..... | 35 |
| 226354 | 11211 | Switching Lever Shaft 226353 with 226355 and 226356..... | 1 00 |
| 202305C | 10436 | Switching Lever Shaft Center..... | 06 |
| 200043C | 10436 | Switching Lever Shaft Center Set Screw | 04 |

| No. | Plate | Name | Each |
|---------|-------|--|-------|
| 226355 | 11211 | Switching Lever Shaft Spring..... | 30 |
| 226356 | 11204 | Switching Lever Shaft Spring Collar with 200363c | 25 |
| 200363c | 11204 | Switching Lever Shaft Spring Collar Set Screw | 03 |
| 211004 | 11350 | Throat Plate (formerly "26-1-F") 50 needle hole, for needle sizes 3 to 5, for 203253 and 211006..... | 1 00 |
| 226430 | — | Ruffling Combination No. 51 complete... | 16 50 |



No. 226620 COMBINATION

(FORMERLY No. 55.)

For Skirt Manufacture. Folds the Strip Over the Cord With a
Presser Folder, Folds up the Edge of the Material and
Folds Down the Edge of the Ruffle.

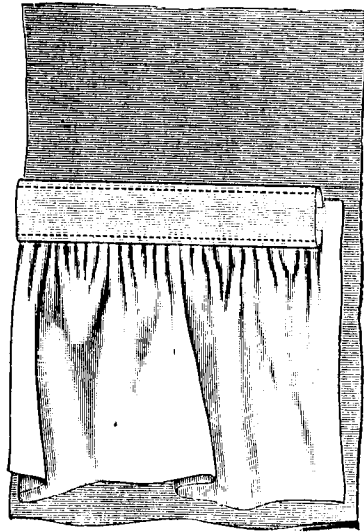
When Ordering, State Gauge Required.

| No. | Plate | Name | Each |
|---------|-------|---|------|
| 226393 | 11214 | Attachment Arm Switch (to the right) with two 200187b..... | 1 25 |
| 226394 | 11214 | Attachment Arm Switch 226393 with 226397 and 226398..... | 2 15 |
| 226395 | 11214 | Attachment Arm Switch Bracket with 200272b, 228032 and two 200911..... | 1 25 |
| 226396 | 11211 | Attachment Arm Switch Bracket 226395 with 226391..... | 3 35 |
| 200911 | 11213 | Attachment Arm Switch Bracket Screw | 05 |
| 200272B | 11213 | Attachment Arm Switch Hinge Screw... | 08 |
| 228032 | 11213 | Attachment Arm Switch Hinge Screw Washer | 01 |
| 226397 | 11213 | Attachment Arm Switch Latch with 200272b and 226398..... | 85 |
| 200272B | 11213 | Attachment Arm Switch Latch Hinge Screw | 08 |
| 226398 | 11213 | Attachment Arm Switch Latch Hinge Screw Washer..... | 01 |

From the library of: Diamond Needle Corp

| No. | Plate | Name | Each |
|---------|-------|--|------|
| 226399 | 11213 | Attachment Arm Switch Latch Spring.. | 05 |
| 211010 | 11355 | Feed Dog (formerly "99") for 211011.... | 60 |
| 226618 | 11516 | Folder (on shank)..... | 2 00 |
| 200187B | 11213 | Folder Screw..... | 04 |
| 226588 | 11515 | Folder and Separating Blade (on shank) | 2 50 |
| 200157B | 11204 | Folder and Separating Blade Screw.... | 05 |
| 226619 | 11521 | Presser Foot (cord guide and strip folder) | 3 00 |
| 226534 | 11505 | Ruffling Blade..... | 50 |
| 202610 | 11305 | Ruffling Blade Clamp..... | 02 |
| 200174D | 11204 | Ruffling Blade Clamp Screw..... | 02 |
| 202597 | 11306 | Ruffling Blade Lever with 202610 and two 200174D..... | 1 25 |
| 202837 | 11218 | Ruffling Blade Lever Bracket with 202599B and two 202602..... | 1 75 |
| 202602 | 11215 | Ruffling Blade Lever Bracket Pin..... | 05 |
| *202973 | — | Ruffling Blade Lever Bracket Position Collar | — |
| *202974 | — | Ruffling Blade Lever Bracket Position Collar Position Pin..... | — |
| 226407 | 11215 | Ruffling Blade Lever Bracket Shaft with 200101D, 202973 and 202974..... | 1 25 |
| 226429 | 11211 | Ruffling Blade Lever Bracket Shaft 226407 with 200289B, 201537, 201566B, 202597, 202598, 202613, 202837 and two 202603..... | 4 75 |
| 202613 | 11213 | Ruffling Blade Lever Bracket Spring.... | 03 |
| 200101B | 11305 | Ruffling Blade Lever Bracket Spring Screw | 04 |
| 200289B | 11202 | Ruffling Blade Lever Hinge Screw..... | 05 |
| 201537 | 11202 | Ruffling Blade Lever Hinge Screw Nut.. | 03 |
| 202598 | 11305 | Ruffling Blade Lever Spring..... | 05 |
| *200771 | — | Ruffling Blade Lever Spring Stud..... | — |
| 202599B | 11305 | Ruffling Blade Lever Spring Stud Bracket with 200771..... | 25 |
| 201566B | 11305 | Ruffling Blade Lever Spring Thumb Nut | 05 |
| 202603 | 11305 | Ruffling Blade Lever Spring Thumb Nut Washer | 01 |
| 202603 | 11305 | Ruffling Blade Lever Spring Washer.... | 01 |
| 226410 | 11211 | Switching Lever with 200043C, 200162, 200284 and 200909E..... | 1 60 |
| 226411 | 11211 | Switching Lever 226410 with 203935, 226348 and 226413..... | 3 00 |
| 226431 | — | Switching Lever 226411 with 226354.... | 4 00 |
| 226347 | 11203 | Switching Lever Bell Crank..... | 50 |
| 226348 | 11206 | Switching Lever Bell Crank 226347 with 200659C and 201528C..... | 60 |
| 200909E | 11203 | Switching Lever Bell Crank Hinge Screw | 05 |
| 202668 | 11306 | Switching Lever Bell Crank Slide Block | 15 |
| 200659C | 11203 | Switching Lever Bell Crank Slide Block Screw Stud..... | 05 |

| No. | Plate | Name | Each |
|---------|-------|--|-------|
| 201528C | 11203 | Switching Lever Bell Crank Slide Block Screw Stud Nut..... | 04 |
| 202104 | 11204 | Switching Lever Bell Crank Slide Block Screw Stud Washer..... | 01 |
| 226413 | 11215 | Switching Lever Latch..... | 50 |
| 200284B | 11204 | Switching Lever Latch Hinge Screw.... | 05 |
| 203935 | 11215 | Switching Lever Latch Spring..... | 02 |
| 202027 | 11215 | Switching Lever Latch Spring Pin..... | 01 |
| 200162 | 11203 | Switching Lever Latch Stop Screw.... | 04 |
| 200043C | 10436 | Switching Lever Pinch Screw..... | 04 |
| 226353 | 11211 | Switching Lever Shaft..... | 35 |
| 226354 | 11211 | Switching Lever Shaft 226353 with 226355 and 226356..... | 1 00 |
| 202305C | 10436 | Switching Lever Shaft Center..... | 06 |
| 200043C | 10436 | Switching Lever Shaft Center Set Screw | 04 |
| 226355 | 11211 | Switching Lever Shaft Spring..... | 30 |
| 226356 | 11204 | Switching Lever Shaft Spring Collar with 200363C..... | 25 |
| 200363C | 11204 | Switching Lever Shaft Spring Collar Set Screw | 03 |
| 211011 | 11358 | Throat Plate (formerly "99-F") 50 needle hole, for needle sizes 3 to 5, made in gauges $\frac{1}{8}$, $\frac{3}{32}$, $\frac{1}{4}$, $\frac{5}{32}$ and $\frac{3}{8}$ inch, for 203462 and 211010..... | 25 |
| 226620 | — | Ruffling Combination No. 55 complete... | 16 00 |



No. 226623 COMBINATION

(FORMERLY No. 57.)

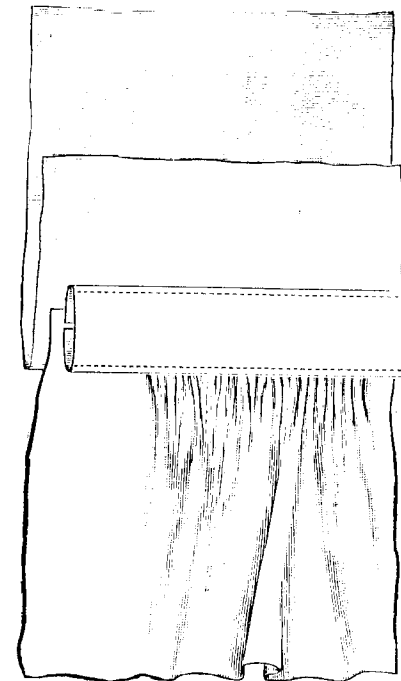
Produces the Same Work as Combination No. 3, Except That It Does Not Fold But Only Guides a Strip Already Folded. When Ordering, State Gauge Required.

| No. | Plate | Name | Each |
|---------|-------|--|------|
| 226537 | 11506 | Attachment Arm Switch (to the right) with two 200157 and 226455..... | 2 00 |
| 200272B | 11213 | Attachment Arm Switch Screw..... | 08 |
| 228032 | 11213 | Attachment Arm Switch Screw Washer.. | 01 |
| 226538 | 11506 | Attachment Arm Switch Bracket with 226398, two 228032 and three 200272b.. | 1 50 |
| 226540 | 11507 | Attachment Arm Switch Latch..... | 70 |
| 200272B | 11213 | Attachment Arm Switch Latch Hinge Screw | 08 |
| 226398 | 11213 | Attachment Arm Switch Latch Hinge Screw Washer..... | 01 |
| 226399 | 11213 | Attachment Arm Switch Latch Spring.. | 05 |
| 200911D | 11213 | Attachment Arm Switch Bracket Screw.. | 05 |
| 211010 | 11355 | Feed Dog (formerly "99") for 211008.... | 60 |
| 226539 | 11506 | Guide and Separating Blade Bracket (intermediate) with two 200175D and four 200174D..... | 1 00 |
| 200157B | 11204 | Guide and Separating Blade Bracket Screw | 05 |

| No. | Plate | Name | Each |
|---------|-------|--|------|
| 226455 | 11221 | Guide and Separating Blade Bracket Screw Clamp Washer..... | 05 |
| 226553 | 11509 | Guide | 50 |
| 200174D | 11204 | Guide Screw..... | 02 |
| 226622 | 11521 | Presser Foot (strip guide)..... | 1 75 |
| 226506 | 11502 | Ruffling Blade..... | 50 |
| 202610 | 11305 | Ruffling Blade Clamp..... | 02 |
| 200174D | 11204 | Ruffling Blade Clamp Screw..... | 02 |
| 202597 | 11306 | Ruffling Blade Lever with 202610 and two 200174D..... | 1 25 |
| *203340 | 11202 | Ruffling Blade Lever Bracket (adjustable) | 25 |
| 203341 | 11306 | Ruffling Blade Lever Bracket (adjustable) 203340 with 202599B..... | 50 |
| 203342 | 11306 | Ruffling Blade Lever Bracket Crank with two each 200098B, 200382C and 202600 | 75 |
| 200382C | 11305 | Ruffling Blade Lever Bracket Crank Set Screw | 02 |
| 200098B | 10138 | Ruffling Blade Lever Bracket Screw.... | 02 |
| 202600 | 11202 | Ruffling Blade Lever Bracket Screw Washer | 01 |
| 200289 | 11202 | Ruffling Blade Lever Hinge Screw..... | 05 |
| 201537 | 11202 | Ruffling Blade Lever Hinge Screw Nut.. | 03 |
| 202598 | 11305 | Ruffling Blade Lever Spring..... | 05 |
| *200771 | --- | Ruffling Blade Lever Spring Stud..... | 05 |
| 202599B | 11305 | Ruffling Blade Lever Spring Stud Bracket with 200771..... | 25 |
| 201566B | 11305 | Ruffling Blade Lever Spring Thumb Nut | 05 |
| 202603 | 11305 | Ruffling Blade Lever Spring Thumb Nut Washer | 01 |
| 202603 | 11305 | Ruffling Blade Lever Spring Washer.... | 01 |
| 226621 | 11521 | Ruffling Separating Blade..... | 35 |
| 202610 | 11305 | Ruffling Separating Blade Clamp..... | 02 |
| 200174D | 11204 | Ruffling Separating Blade Clamp Screw | 02 |
| 226410 | 11211 | Switching Lever with 200043C, 200162, 200284 and 200909E..... | 1 60 |
| 226411 | 11211 | Switching Lever 226410 with 203935 and 226413 | 3 00 |
| 226431 | --- | Switching Lever 226411 with 226354.... | 4 00 |
| 226347 | 11203 | Switching Lever Bell Crank..... | 50 |
| 226348 | 11206 | Switching Lever Bell Crank 226347 with 200659C and 201528D..... | 60 |
| 200909E | 11203 | Switching Lever Bell Crank Hinge Screw | 08 |
| 202668 | 11306 | Switching Lever Bell Crank Slide Block | 15 |
| 200659C | 11203 | Switching Lever Bell Crank Slide Block Screw Stud..... | 05 |
| 201528C | 11203 | Switching Lever Bell Crank Slide Block Screw Stud Nut..... | 04 |
| 202104 | 11204 | Switching Lever Bell Crank Slide Block Screw Stud Washer..... | 01 |

From the library of: Dialectic Needs Corp

| No. | Plate | Name | Each |
|---------|-------|--|-------|
| 226413 | 11215 | Switching Lever Latch..... | 50 |
| 200284B | 11204 | Switching Lever Latch Hinge Screw.... | 05 |
| 203935 | 11215 | Switching Lever Latch Spring..... | 02 |
| 202027 | 11215 | Switching Lever Latch Spring Pin..... | 01 |
| 200162D | 11203 | Switching Lever Latch Stop Screw..... | 04 |
| 200043C | 10436 | Switching Lever Pinch Screw..... | 04 |
| 226353 | 11211 | Switching Lever Shaft..... | 35 |
| 226354 | 11211 | Switching Lever Shaft 226353 with 226355 and 226356..... | 1 00 |
| 202305C | 10436 | Switching Lever Shaft Center..... | 06 |
| 200043C | 10436 | Switching Lever Shaft Center Set Screw | 04 |
| 226355 | 11211 | Switching Lever Shaft Spring..... | 30 |
| 226356 | 11204 | Switching Lever Shaft Spring Collar with 200363C..... | 25 |
| 200363C | 11204 | Switching Lever Shaft Spring Collar Set Screw | 03 |
| 211008 | 11355 | Throat Plate (formerly "99-A") 50 needle hole, for needle sizes 3 to 5, made in gauges $\frac{1}{4}$, $\frac{3}{8}$, $\frac{1}{2}$, $\frac{5}{8}$, $\frac{3}{4}$, $\frac{7}{8}$ inch, for 203462 and 211010..... | 1 50 |
| 226544 | 11507 | Throat Plate Bolster..... | 25 |
| 200157B | 11204 | Throat Plate Bolster Screw..... | 05 |
| 200567 | 11507 | Throat Plate Screw..... | 05 |
| 226623 | — | Ruffling Combination No. 57 complete... | 12 00 |



No. 226631 COMBINATION

(FORMERLY No. 59.)

olds the Material for a Facing, Guides the Ruffle and a Strip
Already Folded.

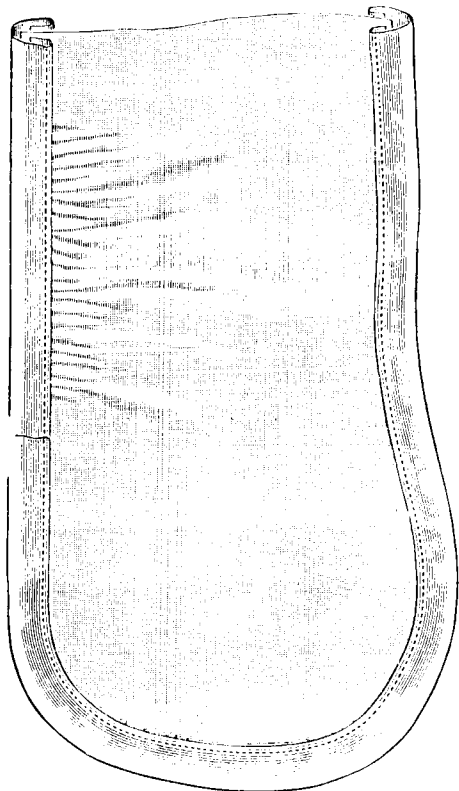
When Ordering, State Gauge Required.

| No. | Plate | Name | Each |
|--------|-------|--|------|
| 11010 | 11355 | Feed Dog (formerly "99") for 211011.... | 60 |
| 26626 | 11523 | Folder (plate) with two 200173..... | 2 50 |
| 26628 | 11523 | Folder (plate) 226626 with 226627 and 226629 | 5 00 |
| 00157B | 11204 | Folder Screw..... | 05 |
| 26627 | 11523 | Guide (on shank) with two 200178 | 1 75 |
| 00173 | 11215 | Guide Screw..... | 04 |
| 26630 | 11524 | Presser Foot (strip guide)..... | 1 75 |
| 26498 | 11500 | Ruffling Blade | 50 |
| 02610 | 11305 | Ruffling Blade Clamp..... | 02 |
| 00174D | 11204 | Ruffling Blade Clamp Screw..... | 02 |
| 02597 | 11306 | Ruffling Blade Lever with 202610 and two 200174D..... | 1 25 |
| 02837 | 11218 | Ruffling Blade Lever Bracket with 202599B and two 202602..... | 1 75 |

| No. | Plate | Name | Each |
|---------|-------|---|------|
| 202602 | 11215 | Ruffling Blade Lever Bracket Pin..... | 05 |
| *202973 | — | Ruffling Blade Lever Bracket Position Collar | -- |
| *202974 | — | Ruffling Blade Lever Bracket Position Collar Position Pin..... | --- |
| 226624 | 11506 | Ruffling Blade Lever Bracket Shaft with 200101b, 202973 and 202974..... | 1 25 |
| 226625 | 11522 | Ruffling Blade Lever Bracket Shaft 226624 with 200289b, 201537, 201566b, 202574, 202597, 202598, 202613, 202837 and two 202603..... | 4 75 |
| 202574 | 11306 | Ruffling Blade Lever Bracket Shaft Collar with 200380c..... | 15 |
| 200380c | 11202 | Ruffling Blade Lever Bracket Shaft Collar Set Screw..... | 02 |
| 202613 | 11213 | Ruffling Blade Lever Bracket Spring.... | 03 |
| 200101b | 11305 | Ruffling Blade Lever Bracket Spring Screw | 04 |
| 200289b | 11202 | Ruffling Blade Lever Hinge Screw..... | 05 |
| 201537 | 11202 | Ruffling Blade Lever Hinge Screw Nut.. | 02 |
| 202598 | 11305 | Ruffling Blade Lever Spring..... | 07 |
| *200771 | — | Ruffling Blade Lever Spring Stud..... | — |
| 202599b | 11305 | Ruffling Blade Lever Spring Stud Bracket with 200771..... | 27 |
| 201566b | 11305 | Ruffling Blade Lever Spring Thumb Nut | 05 |
| 202603 | 11305 | Ruffling Blade Lever Spring Thumb Nut Washer | 01 |
| 202603 | 11305 | Ruffling Blade Lever Spring Washer.... | 01 |
| 226629 | 11521 | Ruffling Separating Blade..... | 21 |
| 200178b | 11203 | Ruffling Separating Blade Screw..... | 01 |
| 226410 | 11211 | Switching Lever with 200043c, 200162, 200284 and 200909e..... | 1 6 |
| 226411 | 11211 | Switching Lever 226410 with 203935, 226348 and 226413..... | 3 0 |
| 226347 | 11203 | Switching Lever Bell Crank..... | 5 |
| 226348 | 11206 | Switching Lever Bell Crank 226347 with 200659c and 201528b..... | 6 |
| 200909e | 11203 | Switching Lever Bell Crank Hinge Screw | 0 |
| 202668 | 11306 | Switching Lever Bell Crank Slide Block | 1 |
| 200659c | 11203 | Switching Lever Bell Crank Slide Block Screw Stud..... | 0 |
| 201528b | 11203 | Switching Lever Bell Crank Slide Block Screw Stud Nut..... | 0 |
| 202104 | 11204 | Switching Lever Bell Crank Slide Block Screw Stud Washer..... | 0 |
| 226413 | 11215 | Switching Lever Latch..... | 5 |
| 200284b | 11204 | Switching Lever Latch Hinge Screw.... | 0 |
| 203935 | 11215 | Switching Lever Latch Spring..... | 0 |
| 202027 | 11215 | Switching Lever Latch Spring Pin..... | 0 |
| 200162 | 11203 | Switching Lever Stop Screw..... | 0 |

| No. | Plate | Name | Each |
|---------|-------|--|-------|
| 200043c | 10436 | Switching Lever Pinch Screw..... | 04 |
| 226353 | 11211 | Switching Lever Shaft..... | 35 |
| 226354 | 11211 | Switching Lever Shaft 226353 with 226355 and 226356..... | 1 00 |
| 202305c | 10436 | Switching Lever Shaft Center..... | 06 |
| 200043c | 10436 | Switching Lever Shaft Center Set Screw | 04 |
| 226355 | 11211 | Switching Lever Shaft Spring..... | 30 |
| 226356 | 11204 | Switching Lever Shaft Spring Collar with 200363c | 25 |
| 200363c | 11204 | Switching Lever Shaft Spring Collar Set Screw | 03 |
| 211011 | 11358 | Throat Plate (formerly "99-F") 50 needle hole, for needle sizes 3 to 5, made in gauges 1, 2, 3, 4 and 5 inch, for 203462 and 211010..... | 1 25 |
| 226631 | — | Ruffling Combination No. 59 complete. | 13 50 |

From the library of: Diamond Needle Corp.



No. 226443 COMBINATION

(FORMERLY No. 60.)

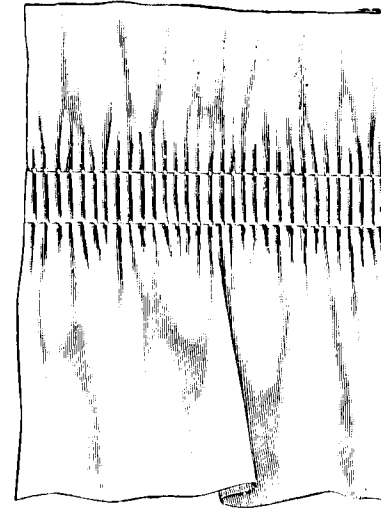
For Binding and Gathering Irregular Shapes. Has a Switching Device for Finishing at the End of the Circuit.

| No. | Plate | Name | Each |
|--|-------|---|------|
| 226434 | 11218 | Binder on shank..... | 1 00 |
| 226435 | 11224 | Binder Swing Bracket complete..... | 1 00 |
| Note: For descriptive items of 226435 see Swing Bracket for Attachments. | | | |
| 211006 | 11350 | Feed Dog (formerly "26-F") for 211005.. | 75 |
| 226437 | 11218 | Presser Foot (hinged)..... | 1 75 |
| 202090 | 10443 | Presser Foot Hinge Pin..... | 01 |
| 226438 | 11218 | Presser Foot Plate..... | 1 50 |
| 202924 | 11218 | Presser Foot Shank..... | 60 |

| No. | Plate | Name | Each |
|---------------------------------------|-------|---|------|
| 226439 | 11221 | Ruffling Blade..... | 35 |
| 202610 | 11305 | Ruffling Blade Clamp..... | 02 |
| 200174d | 11204 | Ruffling Blade Clamp Screw..... | 02 |
| 202597 | 11306 | Ruffling Blade Lever with 202610 and two 200174d..... | 1 25 |
| 202837 | 11218 | Ruffling Blade Lever Bracket with 202599b and two 202602..... | 1 75 |
| 202602 | 11215 | Ruffling Blade Lever Bracket Pin..... | 05 |
| *202973 | — | Ruffling Blade Lever Bracket Position Collar..... | — |
| *202974 | — | Ruffling Blade Lever Bracket Position Collar Position Pin..... | — |
| 226407 | 11215 | Ruffling Blade Lever Bracket Shaft with 200101b, 202973 and 202974..... | 1 25 |
| 226429 | 11211 | Ruffling Blade Lever Bracket Shaft 226407 with 200289b, 201537, 201566b, 202597, 202598, 202613, 202837 and two 202603..... | 4 75 |
| 202613 | 11213 | Ruffling Blade Lever Bracket Spring.... | 03 |
| 200101b | 11305 | Ruffling Blade Lever Bracket Spring Screw..... | 04 |
| 200289b | 11202 | Ruffling Blade Lever Hinge Screw..... | 05 |
| 201537 | 11202 | Ruffling Blade Lever Hinge Screw Nut.. | 03 |
| 202598 | 11305 | Ruffling Blade Lever Spring..... | 05 |
| *200771 | — | Ruffling Blade Lever Spring Stud..... | — |
| 202599b | 11305 | Ruffling Blade Lever Spring Stud Bracket with 200771..... | 25 |
| 201566b | 11305 | Ruffling Blade Lever Spring Thumb Nut | 05 |
| 202603 | 11305 | Ruffling Blade Lever Spring Thumb Nut Washer..... | 01 |
| 202603 | 11305 | Ruffling Blade Lever Spring Washer.... | 01 |
| 226440 | 11221 | Separating Blade on Shank with 200173b | 50 |
| 226441 | 11219 | Separating Blade 226440 with 226442.... | 75 |
| 226442 | 11221 | Separating Blade Ribbon Guide..... | 25 |
| 200183b | 11221 | Separating Blade Ribbon Guide Screw.. | 02 |
| 200157b | 11204 | Separating Blade Screw..... | 05 |
| SWING BRACKET FOR ATTACHMENTS. | | | |
| 226110 | 11220 | Swing Bracket with 200369b and 200855e | 40 |
| 226435 | 11224 | Swing Bracket 226110 with 201563b, 225735, 225925 and two 200157b..... | 1 00 |
| 200369b | 11220 | Swing Bracket Adjusting Screw..... | 06 |
| 225735 | 11220 | Swing Bracket Base..... | 40 |
| 200157b | 11204 | Swing Bracket Base Screw..... | 05 |
| 200157b | 11204 | Swing Bracket Hinge Screw..... | 05 |
| 225925 | 11220 | Swing Bracket Hinge Screw Spring Washer..... | 05 |
| 200855e | 11220 | Swing Bracket Screw Stud..... | 02 |
| 201563b | 11220 | Swing Bracket Screw Stud Thumb Nut | 10 |

From the library of: Diamond Needle Corp

| No. | Plate | Name | Each |
|---------|-------|--|-------|
| 226410 | 11211 | Switching Lever with 200043c, 200162, 200284 and 200909e..... | 1 60 |
| 226411 | 11211 | Switching Lever 226410 with 203935, 226348 and 226413..... | 3 00 |
| 226347 | 11203 | Switching Lever Bell Crank..... | 50 |
| 226348 | 11206 | Switching Lever Bell Crank 226347 with 200659c and 201528b..... | 60 |
| 200909e | 11203 | Switching Lever Bell Crank Hinge Screw | 08 |
| 202668 | 11306 | Switching Lever Bell Crank Slide Block | 15 |
| 200659c | 11203 | Switching Lever Bell Crank Slide Block Screw Stud..... | 05 |
| 201528b | 11203 | Switching Lever Bell Crank Slide Block Screw Stud Nut..... | 04 |
| 202104 | 11204 | Switching Lever Bell Crank Slide Block Screw Stud Washer..... | 01 |
| 226413 | 11215 | Switching Lever Latch..... | 50 |
| 200284b | 11204 | Switching Lever Latch Hinge Screw.... | 05 |
| 203935 | 11215 | Switching Lever Latch Spring..... | 02 |
| 202027 | 11215 | Switching Lever Latch Spring Pin..... | 01 |
| 200162 | 11203 | Switching Lever Stop Screw..... | 04 |
| 200043c | 10436 | Switching Lever Pinch Screw..... | 04 |
| 226353 | 11211 | Switching Lever Shaft..... | 35 |
| 226354 | 11211 | Switching Lever Shaft 226353 with 226355 and 226356..... | 1 00 |
| 202305c | 10436 | Switching Lever Shaft Center..... | 06 |
| 200043c | 10436 | Switching Lever Shaft Center Set Screw | 04 |
| 226355 | 11211 | Switching Lever Shaft Spring..... | 30 |
| 226356 | 11204 | Switching Lever Shaft Spring Collar with 200363c..... | 25 |
| 200363c | 11204 | Switching Lever Shaft Spring Collar Set Screw | 03 |
| 211005 | 11350 | Throat Plate, 50 needle hole, for needle sizes 3 to 5, for 203253 and 211006.... | 1 00 |
| 226443 | — | Ruffling Combination No. 60 complete.... | 10 00 |



No. 22632 COMBINATION

(FORMERLY No. 62.)

Produces a Plain Ruffle. Has a Switching Device That Throws the Ruffling Blade Out of Action to do Plain Sewing.

When Ordering, State Gauge Required.

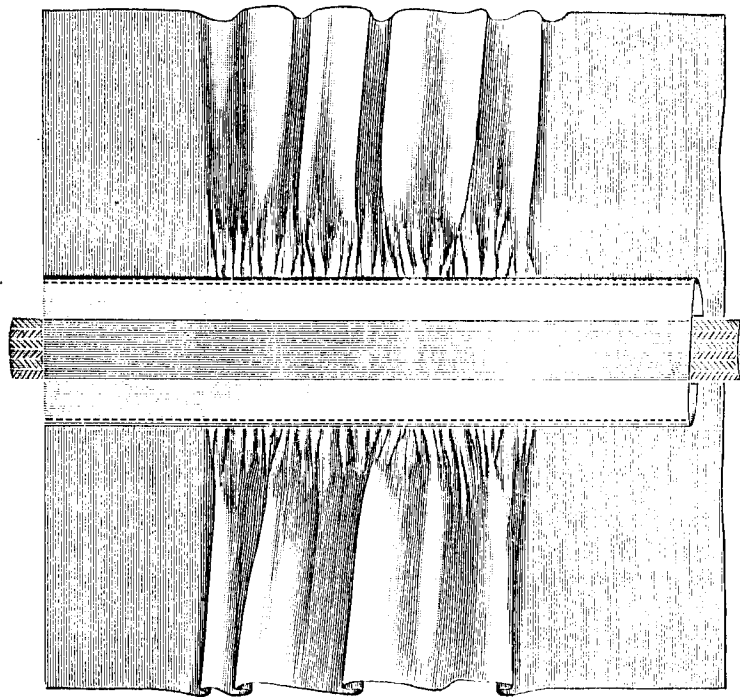
| No. | Plate | Name | Each |
|---------|-------|--|------|
| 211010 | 11355 | Feed Dog (formerly "99") for 211011.... | 60 |
| 203405 | 11303 | Ruffling Blade..... | 50 |
| 202610 | 11305 | Ruffling Blade Clamp..... | 02 |
| 200174b | 11204 | Ruffling Blade Clamp Screw..... | 02 |
| 203336 | 11306 | Ruffling Blade Driving Lever..... | 1 10 |
| 203337 | 11304 | Ruffling Blade Driving Lever 203336 with 200101b, 203338 and 203339..... | 1 25 |
| 203338 | 11306 | Ruffling Blade Driving Lever Shaft..... | 15 |
| 202574 | 11306 | Ruffling Blade Driving Lever Shaft Collar with 200380c..... | 15 |
| 200380c | 11202 | Ruffling Blade Driving Lever Shaft Collar Set Screw..... | 02 |
| 203339 | 11306 | Ruffling Blade Driving Lever Shaft Position Pin..... | 02 |
| 202668 | 11306 | Ruffling Blade Driving Lever Slide Block | 15 |
| 202597 | 11306 | Ruffling Blade Lever with 202610 and two 200174b | 1 25 |
| 203340 | 11202 | Ruffling Blade Lever Bracket (adjustable) | 25 |

From the library of: Diamond Needle Corp

| No. | Plate | Name | Each |
|---------|-------|--|------|
| 203341 | 11306 | Ruffling Blade Lever Bracket (adjustable) 203340 with 202599b..... | 50 |
| 203342 | 11306 | Ruffling Blade Lever Bracket Crank with two each 200098b, 200382c and 202607 | 75 |
| 200382c | 11305 | Ruffling Blade Lever Bracket Crank Set Screw | 02 |
| 200098b | 10438 | Ruffling Blade Lever Bracket Screw..... | 03 |
| 202600 | 11202 | Ruffling Blade Lever Bracket Screw Washer | 01 |
| 200289 | 11202 | Ruffling Blade Lever Hinge Screw..... | 05 |
| 201537 | 11202 | Ruffling Blade Lever Hinge Screw Nut.. | 03 |
| 202598 | 11305 | Ruffling Blade Lever Spring..... | 05 |
| *200771 | — | Ruffling Blade Lever Spring Stud..... | — |
| 202599b | 11305 | Ruffling Blade Lever Spring Stud Bracket with 200771..... | 25 |
| 201566b | 11305 | Ruffling Blade Lever Spring Thumb Nut | 05 |
| 202603 | 11305 | Ruffling Blade Lever Spring Thumb Nut Washer | 01 |
| 202603 | 11305 | Ruffling Blade Lever Spring Washer.... | 01 |
| 202605b | 11306 | Ruffling Blade Lifting Lever..... | 25 |
| 200168c | 11306 | Ruffling Blade Lifting Lever Set Screw | 02 |
| 202606 | 11303 | Ruffling Blade Lifting Lever Stud (adjustable) | 45 |
| 226340 | 11202 | Ruffling Blade Lifting Lever Stud 202606 with 202605b..... | 70 |
| 200072c | 11010 | Ruffling Blade Lifting Lever Pinch Screw | 03 |
| 202607 | 11307 | Ruffling Blade Regulating Lever with two 200382c..... | 1 50 |
| 202608 | 11303 | Ruffling Blade Regulating Lever Index Slide | 25 |
| 200157b | 11204 | Ruffling Blade Regulating Lever Index Slide Stop Screw..... | 05 |
| 203349 | 11307 | Ruffling Blade Regulating Lever Index Slide Stop Screw Washer..... | 03 |
| 200382c | 11305 | Ruffling Blade Regulating Lever Set Screw | 01 |
| 203345 | 11307 | Ruffling Blade Regulating Lever Shaft.. | 25 |
| 201600b | 11307 | Ruffling Blade Regulating Lever Wing Nut | 20 |
| 203344 | 11307 | Ruffling Blade Regulating Lever Washer | 03 |
| 203407 | 11303 | Ruffling Separating Blade..... | 75 |
| 200157b | 11204 | Ruffling Separating Blade Screw..... | 05 |
| 226410 | 11211 | Switching Lever with 200043c, 200162, 200284 and 200909e..... | 1 60 |
| 226411 | 11211 | Switching Lever 226410 with 203935, 226348 and 226413..... | 3 00 |
| 226347 | 11203 | Switching Lever Bell Crank..... | 50 |
| 226348 | 11206 | Switching Lever Bell Crank 226347 with 200659c and 201528b..... | 60 |
| 200909e | 11203 | Switching Lever Bell Crank Hinge Screw | 08 |

| No. | Plate | Name | Each |
|---------|-------|---|------|
| 202668 | 11306 | Switching Lever Bell Crank Slide Block | 15 |
| 200659c | 11203 | Switching Lever Bell Crank Slide Block Screw Stud..... | 05 |
| 201528b | 11203 | Switching Lever Bell Crank Slide Block Screw Stud Nut..... | 04 |
| 202104 | 11204 | Switching Lever Bell Crank Slide Block Screw Stud Washer..... | 01 |
| 226413 | 11215 | Switching Lever Latch..... | 50 |
| 200281b | 11201 | Switching Lever Latch Hinge Screw.... | 05 |
| 203935 | 11215 | Switching Lever Latch Spring Pin..... | 02 |
| 200162 | 11203 | Switching Lever Stop Screw..... | 04 |
| 200043c | 10436 | Switching Lever Pinch Screw..... | 04 |
| 226353 | 11211 | Switching Lever Shaft..... | 35 |
| 226354 | 11211 | Switching Lever Shaft 226353 with 226355 and 226356..... | 00 |
| 202305c | 10436 | Switching Lever Shaft Center..... | 06 |
| 200043c | 10436 | Switching Lever Shaft Center Set Screw | 04 |
| 226355 | 11211 | Switching Lever Shaft Spring..... | 30 |
| 226356 | 11204 | Switching Lever Shaft Spring Collar with 200363c | 25 |
| 200363c | 11204 | Switching Lever Shaft Spring Collar Set Screw | 03 |
| 211011 | 11358 | Throat Plate (formerly "99-F") 50 needle hole, for needle sizes 3 to 5, made in gauges from $\frac{1}{4}$ in. to $\frac{3}{8}$ in. in steps of $\frac{1}{16}$ in., for 203462 and 211010..... | 1 25 |
| 226632 | — | Ruffling Combination No. 62 complete... | 4 50 |

From the library of: Diamond Needle Corp



No. 226636 COMBINATION

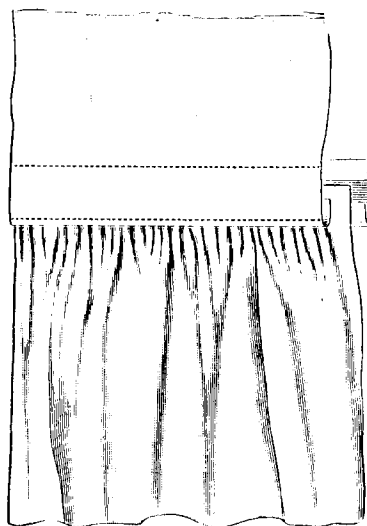
(FORMERLY No. 63.)

Produces the Same Work as Combination No. 38. No. 63 Has a Presser Guide for the Strip and No. 38 Has Not. When Ordering, State Gauge Required.

| No. | Plate | Name | Each |
|---------|-------|--|------|
| 211027 | 11356 | Feed Dog (formerly "44") for 211025 and 211026 | 75 |
| 226633 | 11524 | Presser Foot Strip Guide (and puckering string guide)..... | 2 25 |
| 226634 | 11524 | Ruffling Blade..... | 50 |
| 202610 | 11305 | Ruffling Blade Clamp..... | 02 |
| 200174D | 11204 | Ruffling Blade Clamp Screw..... | 02 |
| 202597 | 11306 | Ruffling Blade Lever with 202610 and two 200174D | 1 25 |
| *203340 | 11202 | Ruffling Blade Lever Bracket (adjustable) | 25 |

| No. | Plate | Name | Each |
|---------|-------|---|------|
| 203341 | 11306 | Ruffling Blade Lever Bracket (adjustable) 203340 with 202599B..... | 50 |
| 203342 | 11306 | Ruffling Blade Lever Bracket Crank with two each 200098B, 200382C and 202600 | 75 |
| 200382C | 11305 | Ruffling Blade Lever Bracket Crank Set Screw | 02 |
| 200098B | 10438 | Ruffling Blade Lever Bracket Screw.... | 03 |
| 202600 | 11202 | Ruffling Blade Lever Bracket Screw Washer | 01 |
| 200289 | 11202 | Ruffling Blade Lever Hinge Screw..... | 05 |
| 201537 | 11202 | Ruffling Blade Lever Hinge Screw Nut.. | 03 |
| 202598 | 11305 | Ruffling Blade Lever Spring..... | 05 |
| *200771 | — | Ruffling Blade Lever Spring Stud..... | — |
| 202599B | 11305 | Ruffling Blade Lever Spring Stud Bracket with 200771..... | 25 |
| 201566B | 11305 | Ruffling Blade Lever Spring Thumb Nut | 05 |
| 202603 | 11305 | Ruffling Blade Lever Spring Thumb Nut Washer | 01 |
| 202603 | 11305 | Ruffling Blade Lever Spring Washer.... | 01 |
| 202605B | 11306 | Ruffling Blade Lifting Lever..... | 2 25 |
| 200168C | 11306 | Ruffling Blade Lifting Lever Set Screw.. | 02 |
| 202606 | 11303 | Ruffling Blade Lifting Lever Stud (adjustable) | 45 |
| 226340 | 11202 | Ruffling Blade Lifting Lever Stud 202606 with 202605B..... | 70 |
| 200072C | 11010 | Ruffling Blade Lifting Lever Pinch Screw | 03 |
| 226635 | 11524 | Ruffling Separating Blade..... | 75 |
| 211025 | 11356 | Throat Plate (formerly "44-F") 50 needle hole, for needle sizes 3 to 5, made in gauges $\frac{1}{8}$, $\frac{3}{16}$, $\frac{1}{4}$ and $\frac{5}{16}$ inch, for 203462 and 211027..... | 1 25 |
| 211026 | 11356 | Throat Plate (formerly "44-F") 46 needle hole, for needle sizes 5 to 7, made in gauges $\frac{1}{8}$, $\frac{3}{16}$, $\frac{1}{4}$ and $\frac{5}{16}$ inch, for 203462 and 211027..... | 1 25 |
| 226636 | — | Ruffling Combination No. 63 complete... | 4 00 |

From the library of: Diamond Needle Corp



No. 226646 COMBINATION

(FORMERLY No. 64.)

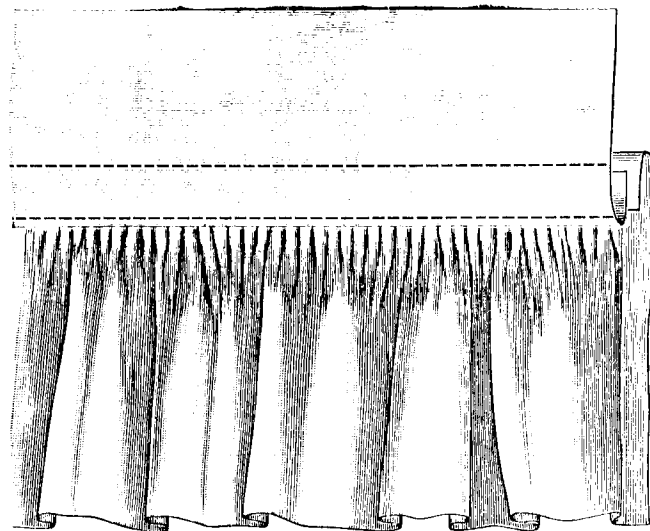
Guides a Folded Strip, Folds the Edge of the Material and Guides the Ruffle.

When Ordering, State Gauge Required.

| No. | Plate | Name | Each |
|---------|-------|--|------|
| 211010 | 11355 | Feed Dog (formerly "99") for 211011.... | 60 |
| 226637 | 11525 | Guide (on shank)..... | 1 25 |
| 226638 | 11525 | Guide Base Plate with two each 200170B and 200174b..... | 75 |
| 200170B | 11514 | Guide Screw..... | 04 |
| 200157B | 11204 | Guide Base Plate Screw..... | 05 |
| 226642 | 11526 | Guide Base Plate 226638 with 226637, and 226639 to 226641..... | 4 50 |
| 226643 | 11526 | Presser Foot with two 200164..... | 1 25 |
| 226644 | 11526 | Presser Foot Folder..... | 2 00 |
| 226645 | 11526 | Presser Foot 226643 with 226644..... | 3 25 |
| 226498 | 11500 | Ruffling Blade..... | 50 |
| 202607 | 11307 | Ruffling Blade Regulating Lever with two 200382c..... | 1 50 |
| 202608 | 11303 | Ruffling Blade Regulating Lever Index Slide..... | 25 |
| 203343 | 11303 | Ruffling Blade Regulating Lever Index Slide Stop..... | 25 |
| 200157B | 11204 | Ruffling Blade Regulating Lever Index Slide Stop Screw..... | 01 |
| 203349 | 11307 | Ruffling Blade Regulating Lever Index Slide Stop Screw Washer..... | 01 |

| No. | Plate | Name | Each |
|---------|-------|---|------|
| 200382c | 11305 | Ruffling Blade Regulating Lever Set Screw..... | 02 |
| 203345 | 11307 | Ruffling Blade Regulating Lever Shaft... | 25 |
| 201600B | 11307 | Ruffling Blade Regulating Lever Wing Nut..... | 20 |
| 202609 | 11307 | Ruffling Blade Regulating Lever Wing Nut Stud Slide..... | 35 |
| 203344 | 11307 | Ruffling Blade Regulating Lever Washer..... | 03 |
| 226640 | 11525 | Ruffling Separating Blade..... | 50 |
| 200174b | 11204 | Ruffling Separating Blade Screw..... | 02 |
| 226641 | 11525 | Ruffling Separating Blade Bracket with two 200174..... | 50 |
| 200170B | 11514 | Ruffling Separating Blade Bracket Screw..... | 04 |
| 226639 | 11525 | Strip Guide (for folded strip)..... | 50 |
| 226410 | 11211 | Switching Lever with 200043c, 200162, 200281 and 200909e..... | 60 |
| 226411 | 11211 | Switching Lever 226410 with 203935, 226348 and 226413..... | 00 |
| 226347 | 11203 | Switching Lever Bell Crank..... | 50 |
| 226348 | 11206 | Switching Lever Bell Crank 226347 with 200659c and 201528D..... | 60 |
| 200909e | 11203 | Switching Lever Bell Crank Hinge Screw..... | 08 |
| 202668 | 11306 | Switching Lever Bell Crank Slide Block..... | 15 |
| 200659c | 11203 | Switching Lever Bell Crank Slide Block Screw Stud..... | 05 |
| 201528D | 11203 | Switching Lever Bell Crank Slide Block Screw Stud Nut..... | 04 |
| 202104 | 11204 | Switching Lever Bell Crank Slide Block Screw Stud Washer..... | 02 |
| 226413 | 11215 | Switching Lever Latch..... | 50 |
| 200284B | 11204 | Switching Lever Latch Hinge Screw.... | 05 |
| 203935 | 11215 | Switching Lever Latch Spring..... | 02 |
| 202027 | 11215 | Switching Lever Latch Spring Pin..... | 01 |
| 200162 | 11203 | Switching Lever Stop Screw..... | 04 |
| 200043c | 10436 | Switching Lever Pinch Screw..... | 04 |
| 226353 | 11211 | Switching Lever Shaft..... | 35 |
| 226354 | 11211 | Switching Lever Shaft 226353 with 226355 and 226356..... | 1 00 |
| 202305c | 10436 | Switching Lever Shaft Center..... | 06 |
| 200043c | 10436 | Switching Lever Shaft Center Set Screw..... | 04 |
| 226355 | 11211 | Switching Lever Shaft Spring..... | 30 |
| 226356 | 11204 | Switching Lever Shaft Spring Collar with 200363c..... | 25 |
| 200363c | 11204 | Switching Lever Shaft Spring Collar Set Screw..... | 03 |
| 211011 | 11358 | Throat Plate (formerly "99-F") 50 needle hole, for needle sizes 3 to 5, made in gauges from $\frac{1}{8}$ in. to $\frac{3}{8}$ in. in steps of $\frac{1}{16}$ in., for 203462 and 211010..... | 1 25 |
| 226646 | --- | Ruffling Combination No. 64 complete... | 8 00 |

From the library of: Diamond Needle Corp



No. 226784 COMBINATION

(FORMERLY No. 65.)

Folds Up the Edge of the Material and Folds Down the Edge of the Ruffle.

When Ordering, State Gauge Required.

| No. | Plate | Name | Each |
|---------|-------|--|------|
| 226393 | 11214 | Attachment Arm Switch (to the right) with two 200187B..... | 1 25 |
| 226394 | 11214 | Attachment Arm Switch 226393 with 226397 and 226399..... | 2 15 |
| 226395 | 11214 | Attachment Arm Switch Bracket with 200272B, 228032 and two 200911..... | 1 25 |
| 226396 | 11211 | Attachment Arm Switch Bracket 226395 with 226394..... | 3 35 |
| 200911 | 11213 | Attachment Arm Switch Bracket Screw | 05 |
| 200272B | 11213 | Attachment Arm Switch Hinge Screw... | 08 |
| 228032 | 11213 | Attachment Arm Switch Hinge Screw Washer | 01 |
| 226397 | 11213 | Attachment Arm Switch Latch with 200272B and 226398..... | 85 |
| 200272B | 11213 | Attachment Arm Switch Latch Hinge Screw | 08 |
| 226398 | 11213 | Attachment Arm Switch Latch Hinge Screw Washer..... | 01 |
| 226399 | 11213 | Attachment Arm Switch Latch Spring.. | 05 |

| No. | Plate | Name | Each |
|---------|-------|--|------|
| 211010 | 11355 | Feed Dog (formerly "99") for 211011 .. | 60 |
| 226781 | 11548 | Folder (on shank)..... | 2 50 |
| 226782 | 11516 | Folder (upper) (on shank)..... | 2 00 |
| 200157B | 11204 | Folder Screw..... | 05 |
| 226724 | 11532 | Presser Foot..... | 1 00 |
| 226506 | 11502 | Ruffling Blade..... | 50 |
| 202610 | 11305 | Ruffling Blade Clamp..... | 02 |
| 200174b | 11204 | Ruffling Blade Clamp Screw..... | 02 |
| 202597 | 11306 | Ruffling Blade Lever with 202610 and two 200174b | 1 25 |
| 202837 | 11218 | Ruffling Blade Lever Bracket with 202599B and two 202602..... | 1 75 |
| 202602 | 11215 | Ruffling Blade Lever Bracket Pin..... | 05 |
| *202973 | ---- | Ruffling Blade Lever Bracket Position Collar | 05 |
| *202974 | ---- | Ruffling Blade Lever Bracket Position Collar Position Pin..... | 05 |
| 226407 | 11215 | Ruffling Blade Lever Bracket Shaft with 200101b, 202973 and 202974..... | 1 25 |
| 226429 | 11211 | Ruffling Blade Lever Bracket Shaft 226407 with 200289B, 201537, 201566B, 202597, 202598, 202613, 202837 and two 202603 | 4 75 |
| 202613 | 11213 | Ruffling Blade Lever Bracket Spring.... | 03 |
| 200101B | 11305 | Ruffling Blade Lever Bracket Spring Screw | 04 |
| 200289B | 11202 | Ruffling Blade Lever Hinge Screw..... | 05 |
| 201537 | 11202 | Ruffling Blade Lever Hinge Screw Nut.. | 03 |
| 202598 | 11305 | Ruffling Blade Lever Spring..... | 05 |
| *200771 | ---- | Ruffling Blade Lever Spring Stud..... | -- |
| 202599B | 11305 | Ruffling Blade Lever Spring Stud Bracket with 200771..... | 25 |
| 201566B | 11305 | Ruffling Blade Lever Spring Thumb Nut | 05 |
| 202603 | 11305 | Ruffling Blade Lever Spring Thumb Nut Washer | 01 |
| 202603 | 11305 | Ruffling Blade Lever Spring Washer.... | 01 |
| 226410 | 11211 | Switching Lever with 200043c, 200162, 200284 and 200909E..... | 1 60 |
| 226411 | 11211 | Switching Lever 226410 with 203935, 226348 and 226413..... | 3 00 |
| 226431 | ---- | Switching Lever 226411 with 226354.... | 4 00 |
| 226347 | 11203 | Switching Lever Bell Crank..... | 50 |
| 226348 | 11206 | Switching Lever Bell Crank 226347 with 200659c and 201528c..... | 60 |
| 200909E | 11203 | Switching Lever Bell Crank Hinge Screw | 08 |

From the library of: Diamond Needle Corp

| No. | Plate | Name | Each |
|---------|-------|--|-------|
| 202668 | 11306 | Switching Lever Bell Crank Slide Block | 15 |
| 200659c | 11203 | Switching Lever Bell Crank Slide Block Screw Stud..... | 05 |
| 201528c | 11203 | Switching Lever Bell Crank Slide Block Screw Stud Nut..... | 04 |
| 202104 | 11204 | Switching Lever Bell Crank Slide Block Screw Stud Washer..... | 01 |
| 226413 | 11215 | Switching Lever Latch..... | 50 |
| 200284B | 11204 | Switching Lever Latch Hinge Screw.... | 02 |
| 203935 | 11215 | Switching Lever Latch Spring..... | 01 |
| 202027 | 11215 | Switching Lever Latch Spring Pin..... | 01 |
| 200162 | 11203 | Switching Lever Latch Stop Screw..... | 04 |
| 200043c | 10436 | Switching Lever Pinch Screw..... | 01 |
| 226353 | 11211 | Switching Lever Shaft..... | 35 |
| 226354 | 11211 | Switching Lever Shaft 226353 with 226355 and 226356..... | 1 00 |
| 202305c | 10436 | Switching Lever Shaft Center..... | 06 |
| 200043c | 10436 | Switching Lever Shaft Center Set Screw | 04 |
| 226355 | 11211 | Switching Lever Shaft Spring..... | 30 |
| 226356 | 11204 | Switching Lever Shaft Spring Collar with 200363c | 25 |
| 200363c | 11204 | Switching Lever Shaft Spring Collar Set Screw | 03 |
| 211011 | 11358 | Throat Plate (formerly "99-F") 50 needle hole, for needle sizes 3 to 5, made in gauges from $\frac{1}{4}$ in. to $\frac{3}{8}$ in. in steps of $\frac{1}{32}$ in., for 203462 and 211010..... | 1 25 |
| 226784 | --- | Ruffling Combination No. 65 complete... | 14 00 |

No. 226655 COMBINATION

(FORMERLY No. 66.)

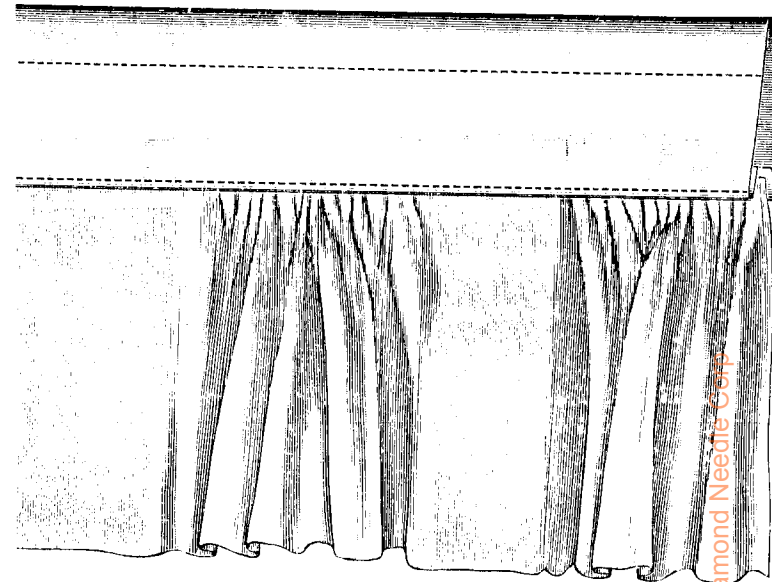
For Corset Cover Work. Folds the Waist Band and Guides the
Puckering Tape Which May be Stitched to the Band,
or Not, as Desired.

When Ordering, State Gauge Required.

| No. | Plate | Name | Each |
|---------|-------|---|-------|
| 211014 | 11356 | Feed Dog (formerly "38") for 211012 and 211013 | 75 |
| 226647 | 11527 | Folder (plate) with two 200173..... | 4 00 |
| 226653 | 11528 | Folder (plate) 226647 with 226648 to 226652 | 15 00 |
| 200157B | 11204 | Folder (plate) Screw..... | 05 |
| 226654 | 11528 | Presser Foot..... | 1 25 |
| 226648 | 11527 | Puckering String Guide with two 200174D | 2 00 |
| 226649 | 11527 | Puckering String Guide Switching Lever | 50 |
| 200174D | 11204 | Puckering String Guide Switching Lever Hinge Screw..... | 02 |
| 200924 | 11541 | Puckering String Guide Switching Lever Screw | 03 |
| 226650 | 11527 | Puckering String Guide Stop..... | 25 |
| 200174D | 11204 | Puckering String Guide Stop Screw..... | 02 |
| 226634 | 11524 | Ruffling Blade..... | 50 |
| 202610 | 11305 | Ruffling Blade Clamp..... | 02 |
| 200174D | 11204 | Ruffling Blade Clamp Screw..... | 02 |
| 202597 | 11306 | Ruffling Blade Lever with 202610 and two 200174D | 1 25 |
| 203340 | 11202 | Ruffling Blade Lever Bracket (adjustable) | 25 |
| 203341 | 11306 | Ruffling Blade Lever Bracket (adjust- able) 203340 with 202599B..... | 50 |
| 03342 | 11306 | Ruffling Blade Lever Bracket Crank with two each 200098B, 200382c and 202600.. | 75 |
| 00382c | 11305 | Ruffling Blade Lever Bracket Crank Set Screw | 02 |
| 00098B | 10138 | Ruffling Blade Lever Bracket Screw..... | 03 |
| 02600 | 11202 | Ruffling Blade Lever Bracket Screw Washer | 01 |
| 00289 | 11202 | Ruffling Blade Lever Hinge Screw..... | 05 |
| 01537 | 11202 | Ruffling Blade Lever Hinge Screw Nut.. | 03 |
| 22598 | 11305 | Ruffling Blade Lever Spring..... | 05 |
| 10771 | --- | Ruffling Blade Lever Spring Stud..... | — |
| 22599B | 11305 | Ruffling Blade Lever Spring Stud Bracket with 200771..... | 25 |
| 21566B | 11305 | Ruffling Blade Lever Spring Thumb Nut | 05 |
| 22603 | 11305 | Ruffling Blade Lever Spring Thumb Nut Washer | 01 |
| 22603 | 11305 | Ruffling Blade Lever Spring Washer... | 01 |
| 22605B | 11305 | Ruffling Blade Lifting Lever..... | 25 |

From the library of: Diamond Needle Corp

| No. | Plate | Name | Each |
|---------|-------|---|------|
| 200168c | 11306 | Ruffling Blade Lifting Lever Set Screw... | 02 |
| 202606 | 11303 | Ruffling Blade Lifting Lever Stud (adjustable) | 45 |
| 200072c | 11010 | Ruffling Blade Lifting Lever Pinch Screw | 03 |
| 226651 | 11527 | Ruffling Separating Blade..... | 50 |
| 226652 | 11527 | Ruffling Separating Blade Bracket with two 200174b..... | 6 00 |
| 200173 | 11215 | Ruffling Separating Blade Bracket Screw | 04 |
| 200174b | 11204 | Ruffling Separating Blade Screw..... | 02 |
| 226410 | 11211 | Switching Lever with 200043c, 200162, 200284 and 200909e..... | 1 60 |
| 226411 | 11211 | Switching Lever 226410 with 203935, 226348 and 226413..... | 3 00 |
| 226431 | — | Switching Lever 226411 with 226354..... | 4 00 |
| 226347 | 11203 | Switching Lever Bell Crank..... | 50 |
| 226348 | 11206 | Switching Lever Bell Crank 226347 with 200659c and 201528b..... | 60 |
| 200909e | 11203 | Switching Lever Bell Crank Hinge Screw | 08 |
| 202668 | 11306 | Switching Lever Bell Crank Slide Block | 15 |
| 200659c | 11203 | Switching Lever Bell Crank Slide Block Screw Stud..... | 05 |
| 201528b | 11203 | Switching Lever Bell Crank Slide Block Screw Stud Nut..... | 04 |
| 202104 | 11204 | Switching Lever Bell Crank Slide Block Screw Stud Washer..... | 01 |
| 226413 | 11215 | Switching Lever Latch..... | 50 |
| 200284b | 11204 | Switching Lever Latch Hinge Screw.... | 05 |
| 203935 | 11215 | Switching Lever Latch Spring..... | 01 |
| 202027 | 11215 | Switching Lever Latch Spring Pin..... | 01 |
| 200162 | 11203 | Switching Lever Stop Screw..... | 04 |
| 200043c | 10436 | Switching Lever Pinch Screw..... | 0- |
| 226353 | 11211 | Switching Lever Shaft..... | 31 |
| 226354 | 11211 | Switching Lever Shaft 226353 with 226355 and 226356..... | 1 00 |
| 202305c | 10436 | Switching Lever Shaft Center..... | 00 |
| 200043c | 10436 | Switching Lever Shaft Center Set Screw | 0 |
| 226355 | 11211 | Switching Lever Shaft Spring..... | 3- |
| 226356 | 11204 | Switching Lever Shaft Spring Collar with 200363c | 2 |
| 200363c | 11204 | Switching Lever Shaft Spring Collar Set Screw | 0 |
| 211012 | 11356 | Throat Plate (formerly "38-F") 50 needle hole, for needle sizes 3 to 5, made in gauges $\frac{3}{8}$, $\frac{13}{16}$ and $\frac{1}{2}$ in., for 203462 and 211014 | 1 2 |
| 211013 | 11356 | Throat Plate (formerly "38-F") 46 needle hole, for needle sizes 5 to 7, made in gauges $\frac{3}{8}$, $\frac{13}{16}$ and $\frac{1}{2}$ in., for 203462 and 211014 | 1 2 |
| 226655 | — | Ruffling Combination No. 66 complete... | 20 0 |



No. 226790 COMBINATION

(FORMERLY No. 67.)

For Making Bands for Ladies' Drawers and Similiar Work. It Ruffles or Gathers at the Will of Operator, Folds Both Edges of a Strip, Inserts and Attaches Strip and Ruffle.

When Ordering, State Gauge Required.

| No. | Plate | Name | Each |
|---------|-------|---|------|
| 226444 | 11222 | Band Strip Guide Bracket with two 200160b | 1 00 |
| 226445 | — | Band Strip Guide Bracket 226444 with 226451 | 1 75 |
| 226446 | 11222 | Band Strip Guide Bracket 226445 with 200048b and 226452..... | 4 50 |
| 200160b | 11213 | Band Strip Guide Bracket Screw..... | 04 |
| 200048b | 11221 | Band Strip Guide Hinge Screw..... | 04 |
| 226448 | 11221 | Band Strip Guide Rod..... | 15 |
| 226449 | 11214 | Band Strip Guide Roller (wood)..... | 25 |
| 225925 | 11220 | Band Strip Guide Roller Spring Washer | 05 |
| 226450 | 11221 | Band Strip Guide Roller Stud..... | 25 |
| 226451 | 11214 | Band Strip Guide Shank..... | 1 00 |
| 226452 | 11222 | Band Strip Guide Shank 226451 with 225925 and 226448 to 226450..... | 1 65 |
| 200160b | 11213 | Band Strip Guide Shank Screw..... | 04 |

From the library of: Diamond Needle Corp.

| No. | Plate | Name | Each |
|---------|-------|--|-------|
| 211014 | 11356 | Feed Dog for 211212 and 211013..... | 75 |
| 226453 | 11222 | Folder and Separating Blade (on shank) (for continuous strips)..... | 12 00 |
| 226454 | 11222 | Folder Base Plate with 226455, two 200187B and four 200160B..... | 75 |
| 225586 | 11221 | Folder Base Plate Position Pin..... | 01 |
| 200187B | 11213 | Folder Screw..... | 04 |
| 226455 | 11221 | Folder Screw Clamp Washer..... | 05 |
| 226456 | 11223 | Presser Foot..... | 1 00 |
| 226786 | 11549 | Ruffling Blade..... | 35 |
| 226778 | 11548 | Ruffling Blade Regulating Lever Shaft... | 25 |
| 211012 | 11356 | Throat Plate (formerly "38-F") 50 needle hole, for needle sizes 3 to 5, made in gauges from $\frac{3}{16}$ in. to $\frac{5}{16}$ in. in steps of $\frac{1}{32}$ in., for 203462 and 211014..... | 1 25 |
| 211013 | 11356 | Throat Plate (formerly "38-F") 46 needle hole, for needle sizes 5 to 7, made in gauges from $\frac{3}{16}$ in. to $\frac{7}{16}$ in. in steps of $\frac{1}{32}$ in., for 203462 and 211014..... | 1 25 |
| 226790 | — | Ruffling Combination No. 67 complete... | 24 00 |

No. 226461 COMBINATION

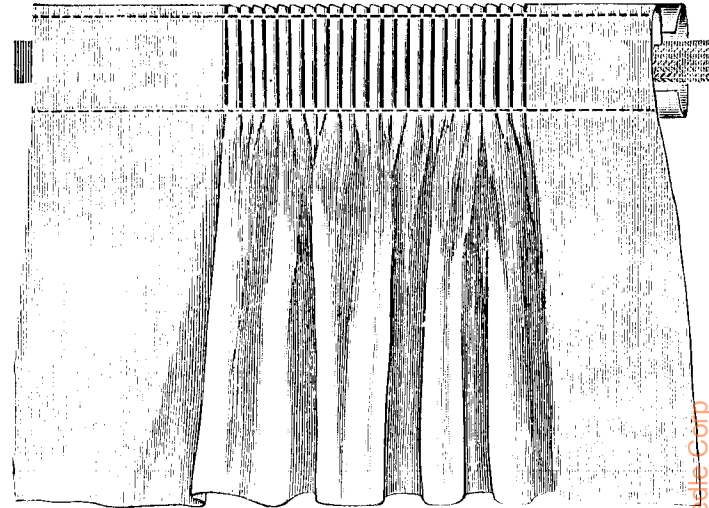
(FORMERLY No. 68.)

For Making Aprons, Bands for Ladies' Drawers and Similiar
Work. It Ruffles or Gathers at Will of Operator, Folds Both
Edges of a Strip, Inserts and Attaches Strip and Ruffle.

| No. | Plate | Name | Each |
|---------|-------|--|-------|
| 226444 | 11222 | Band Strip Guide Bracket with two 200160B..... | 1 00 |
| 226445 | — | Band Strip Guide Bracket 226444 with 226454..... | 1 75 |
| 226446 | 11222 | Band Strip Guide Bracket 226445 with 200048B and 226452..... | 4 50 |
| 200160B | 11213 | Band Strip Guide Bracket Screw..... | 04 |
| 200048B | 11221 | Band Strip Guide Hinge Screw..... | 04 |
| 226448 | 11221 | Band Strip Guide Rod..... | 15 |
| 226449 | 11214 | Band Strip Guide Roller (wood)..... | 25 |
| 225925 | 11220 | Band Strip Guide Roller Spring Washer | 05 |
| 226450 | 11221 | Band Strip Guide Roller Stud..... | 25 |
| 226451 | 11214 | Band Strip Guide Shank..... | 1 00 |
| 226452 | 11222 | Band Strip Guide Shank 226451 with 225925 and 226448 to 226450..... | 1 65 |
| 200160B | 11213 | Band Strip Guide Shank Screw..... | 04 |
| 211011 | 11364 | Feed Dog (formerly "26-1-F") for 211004 | 85 |
| 226453 | 11222 | Folder and Separating Blade (on shank) for continuous strips..... | 12 00 |
| 226454 | 11222 | Folder Base Plate with 226455, two 200187B and four 200160B..... | 75 |
| 225586 | 11221 | Folder Plate Position Pin..... | 01 |
| 200187B | 11213 | Folder Screw..... | 04 |
| 226455 | 11221 | Folder Screw Clamp Washer..... | 05 |
| 226456 | 11223 | Presser Foot..... | 1 00 |
| 226457 | 11223 | Ruffling Blade..... | 35 |
| 226330 | 11202 | Ruffling Blade Clamp..... | 05 |
| 200179B | 11208 | Ruffling Blade Clamp Screw..... | 02 |
| 226341 | 11223 | Ruffling Blade Driving Lever Shaft..... | 25 |
| 202574 | 11306 | Ruffling Blade Driving Lever Shaft Collar with 200380c..... | 15 |
| 200380c | 11202 | Ruffling Blade Driving Lever Shaft Collar Set Screw..... | 02 |
| 226458 | 11223 | Ruffling Blade Lever with 226330 and two 200179B..... | 1 25 |
| 226558 | 11211 | Switching Lever with 200043c, 200284D, 200907E, 200909E and three 200162D.... | 1 60 |
| 226346 | 11211 | Switching Lever 226558 with 226350 to 226352 and 226348..... | 3 75 |

From the Library of: Diamond Needle Corp

| No. | Plate | Name | Each |
|---------|-------|---|-------|
| 226460 | — | Switching Lever 226346 with 226354..... | 4 75 |
| 226347 | 11203 | Switching Lever Bell Crank..... | 50 |
| 226348 | 11206 | Switching Lever Bell Crank 226347 with 200659c and 201528d..... | 60 |
| 200909E | 11203 | Switching Lever Bell Crank Hinge Screw | 08 |
| 202668 | 11306 | Switching Lever Bell Crank Slide Block | 15 |
| 200659c | 11203 | Switching Lever Bell Crank Slide Block Screw Stud..... | 05 |
| 201528c | 11203 | Switching Lever Bell Crank Slide Block Screw Stud Nut..... | 04 |
| 202104 | 11204 | Switching Lever Bell Crank Slide Block Screw Stud Washer..... | 01 |
| 226350 | 11201 | Switching Lever Handle..... | 75 |
| 200162b | 11203 | Switching Lever Handle Screw..... | 04 |
| 226351 | 11201 | Switching Lever Latch..... | 75 |
| 200284b | 11204 | Switching Lever Latch Hinge Screw.... | 05 |
| 226352 | 11203 | Switching Lever Latch Spring..... | 05 |
| 200907E | 11204 | Switching Lever Latch Spring Screw.... | 02 |
| 200162b | 11203 | Switching Lever Latch Stop Screw.... | 04 |
| 200043c | 10436 | Switching Lever Pinch Screw..... | 04 |
| 226353 | 11211 | Switching Lever Shaft..... | 35 |
| 226354 | 11211 | Switching Lever Shaft 226353 with 226355 and 226356..... | 1 00 |
| 202305c | 10436 | Switching Lever Shaft Center..... | 06 |
| 200043c | 10436 | Switching Lever Shaft Center Set Screw | 04 |
| 226355 | 11211 | Switching Lever Shaft Spring..... | 30 |
| 226356 | 11204 | Switching Lever Shaft Spring Collar with 200363c | 25 |
| 200363c | 11204 | Switching Lever Shaft Spring Collar Set Screw | 03 |
| 211004 | 11350 | Throat Plate (formerly "264-F") 50 needle hole, for needle sizes 3 to 5, for 203253 and 211007..... | 1 00 |
| 226461 | — | Ruffling Combination No. 68 complete... | 24 00 |



No. 226661 COMBINATION

(FORMERLY No. 69.)

Used for Banding and Ruffling Skirts, Petticoats and Women's
Muslin Underwear. It Ruffles or Gathers at will of Operator.
Folds Top Edge of the Material, Folds Both Edges of a
Strip and Inserts a Drawing or Puckering Tape.

When Ordering, State Gauge Required.

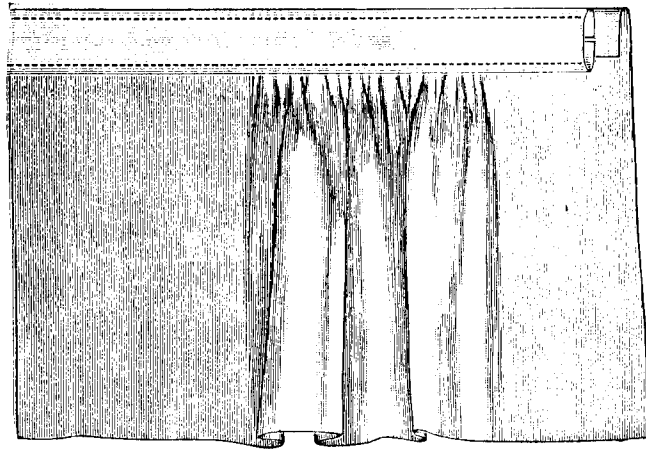
| No. | Plate | Name | Each |
|---------|-------|--|------|
| 226656 | 11529 | Band Strip Folder Guide and Separating Blade with two 200173..... | 5 00 |
| 200157b | 11201 | Band Strip Folder Guide and Separating Blade Screw..... | 05 |
| 226658 | 11529 | Band Strip Folder Guide and Separating Blade 226656 with 226657..... | 7 50 |
| 211035 | 11357 | Feed Dog (formerly "41") for 211033 and 211034 | 85 |
| 211030 | 11356 | Feed Dog (formerly "131-F") for Heavy Work | 75 |
| 226657 | 11528 | Folder (on shank) (upper) for edge of material | 2 50 |
| 226660 | 11528 | Presser Foot..... | 1 50 |
| 202090 | 10443 | Presser Foot Hinge Pin..... | 01 |
| 226752 | — | Presser Foot Plate..... | 1 50 |
| 226566 | 11512 | Presser Foot Plate Spring..... | 25 |
| 200174b | 11204 | Presser Foot Plate Spring Screw..... | 02 |
| 226753 | 11545 | Presser Foot complete, (hinged) Nos. 200174b, 202090, 226566 and 226752, for heavy work..... | 2 25 |

From the library of: Diamond Needle Corp

| No. | Plate | Name | Each |
|---------|-------|--|------|
| 226659 | 11524 | Ruffling Blade..... | 50 |
| 202610 | 11305 | Ruffling Blade Clamp..... | 02 |
| 200174D | 11204 | Ruffling Blade Clamp Screw..... | 02 |
| 202597 | 11306 | Ruffling Blade Lever with 202610 and two 200174D..... | 1 25 |
| *226403 | — | Ruffling Blade Lever Bracket (adjustable)..... | 25 |
| 226404 | 11213 | Ruffling Blade Lever Bracket (adjustable) 226403 with 202599B..... | 50 |
| 226415 | 11216 | Ruffling Blade Lever Bracket 226404 with 200289, 201537, 201566B, 202597, 202598 and two 202603..... | 1 85 |
| 226405 | 11213 | Ruffling Blade Lever Bracket Crank with two each 200098B, 202600 and 202602..... | 1 00 |
| 226406 | 11211 | Ruffling Blade Lever Bracket Crank 226405 with 202613 and 226407..... | 2 25 |
| 202602 | 11215 | Ruffling Blade Lever Bracket Crank Position Pin..... | 05 |
| 202613 | 11213 | Ruffling Blade Lever Bracket Crank Spring..... | 03 |
| 200101D | 11305 | Ruffling Blade Lever Bracket Crank Spring Screw..... | 04 |
| *202973 | — | Ruffling Blade Lever Bracket Position Collar..... | — |
| *202974 | — | Ruffling Blade Lever Bracket Position Collar Position Pin..... | — |
| 200098B | 10438 | Ruffling Blade Lever Bracket Screw..... | 03 |
| 202600 | 11202 | Ruffling Blade Lever Bracket Screw Washer..... | 01 |
| 226407 | 11215 | Ruffling Blade Lever Bracket Shaft with 200101D, 202973 and 202974..... | 1 25 |
| 226408 | 11211 | Ruffling Blade Lever Bracket Shaft 226407 with 226406 and 226415..... | 4 00 |
| 200289 | 11202 | Ruffling Blade Lever Hinge Screw..... | 05 |
| 201537 | 11202 | Ruffling Blade Lever Hinge Screw Nut..... | 05 |
| 202598 | 11305 | Ruffling Blade Lever Spring..... | 05 |
| 200771 | — | Ruffling Blade Lever Spring Stud..... | — |
| 202599B | 11305 | Ruffling Blade Lever Spring Stud Bracket with 200771..... | 25 |
| 201566B | 11305 | Ruffling Blade Lever Spring Thumb Nut..... | 04 |
| 202603 | 11305 | Ruffling Blade Lever Spring Washer..... | 0 |
| 226410 | 11211 | Switching Lever with 200043C, 200162, 200284 and 200909E..... | 1 60 |
| 226411 | 11211 | Switching Lever 226410 with 203935, 226412 and 226413..... | 3 00 |
| 226431 | — | Switching Lever 226411 with 226354..... | 4 00 |
| 226347 | 11203 | Switching Lever Bell Crank..... | 50 |
| 226348 | 11206 | Switching Lever Bell Crank 226347 with 200659C and 201528D..... | 60 |

| No. | Plate | Name | Each |
|---------|-------|---|-------|
| 200909E | 11203 | Switching Lever Bell Crank Hinge Screw..... | 08 |
| 202668 | 11306 | Switching Lever Bell Crank Slide Block..... | 15 |
| 200659C | 11203 | Switching Lever Bell Crank Slide Block Screw Stud..... | 05 |
| 201528C | 11203 | Switching Lever Bell Crank Slide Block Screw Stud Nut..... | 04 |
| 202104 | 11204 | Switching Lever Bell Crank Slide Block Screw Stud Washer..... | 01 |
| 226413 | 11215 | Switching Lever Latch..... | 50 |
| 200284B | 11204 | Switching Lever Latch Hinge Screw..... | 05 |
| 203935 | 11215 | Switching Lever Latch Spring..... | 02 |
| 202027 | 11215 | Switching Lever Latch Spring Pin..... | 01 |
| 200162D | 11203 | Switching Lever Latch Stop Screw..... | 04 |
| 200043C | 10436 | Switching Lever Pinch Screw..... | 04 |
| 226353 | 11211 | Switching Lever Shaft..... | 35 |
| 226354 | 11211 | Switching Lever Shaft 226353 with 226355 and 226356..... | 1 00 |
| 202305C | 10436 | Switching Lever Shaft Center..... | 06 |
| 200043C | 10436 | Switching Lever Shaft Center Set Screw..... | 04 |
| 226355 | 11211 | Switching Lever Shaft Spring..... | 30 |
| 226356 | 11204 | Switching Lever Shaft Spring Collar with 200363C..... | 25 |
| 200363C | 11204 | Switching Lever Shaft Spring Collar Set Screw..... | 03 |
| 226409 | 11213 | Stop Block..... | 35 |
| 211033 | 11357 | Throat Plate (formerly "41-P") 50 needle hole, for needle sizes 3 to 5, made in gauges 3, 3½, 4, 4½ and 5 in., for 203462 and 211035..... | 1 50 |
| 211034 | 11357 | Throat Plate (formerly "41-P") 40 needle hole, for needle sizes 5 to 7, made in gauges 3, 3½, 4, 4½ and 5 in., for 203462 and 211035..... | 1 50 |
| 211031 | 11356 | Throat Plate for Heavy Work..... | 1 25 |
| 211032 | 11356 | Throat Plate for Heavy Work..... | 1 25 |
| 226661 | — | Ruffling Combination No. 69 complete..... | 13 00 |

From the Library of: Donald Needle Corp.



No. 22670 COMBINATION

(FORMERLY No. 70.)

For Finishing Arm Holes and Tops of Waists. Ruffles or Gathers at Will of Operator, Folds Top of Material and Folds and Attaches a Strip.

When Ordering, State Gauge Required.

| No. | Plate | Name | Each |
|---------|-------|--|------|
| 211010 | 11355 | Feed Dog (formerly "99") for 211011.... | 60 |
| 226662 | 11530 | Folder and Separating Blade (on shank) | 3 00 |
| 226664 | 11519 | Folder and Separating Blade Base Plate with 226663 and two 200093B..... | 60 |
| 200093B | 11217 | Folder and Separating Blade Screw..... | 03 |
| 226663 | 11530 | Folder and Separating Blade Screw Clamp Washer..... | 05 |
| 226665 | 11522 | Folder and Separating Blade Base Plate 226664 with 200246, 225708 and 226662 | 3 60 |
| 225708 | 11226 | Folder and Separating Blade Base Plate Spring | 10 |
| 200246 | 11226 | Folder and Separating Blade Base Plate Hinge Screw..... | 08 |
| 203405 | 11303 | Ruffling Blade..... | 50 |
| 202610 | 11305 | Ruffling Blade Clamp..... | 02 |
| 200174D | 11204 | Ruffling Blade Clamp Screw..... | 02 |
| 203336 | 11306 | Ruffling Blade Driving Lever..... | 1 10 |
| 203337 | 11304 | Ruffling Blade Driving Lever 203336 with 200101D, 203338 and 203339..... | 1 25 |

No. 22670 Combination

115

| No. | Plate | Name | Each |
|---------|-------|--|------|
| 203338 | 11306 | Ruffling Blade Driving Lever Shaft..... | 15 |
| 202574 | 11306 | Ruffling Blade Driving Lever Shaft Collar with 200380c..... | 15 |
| 200380c | 11202 | Ruffling Blade Driving Lever Shaft Collar Set Screw..... | 02 |
| 203339 | 11306 | Ruffling Blade Driving Lever Shaft Position Pin..... | 02 |
| 202668 | 11306 | Ruffling Blade Driving Lever Slide Block | 15 |
| 202597 | 11306 | Ruffling Blade Lever with 202610 and two 200174D | 1 25 |
| *203340 | 11202 | Ruffling Blade Lever Bracket (adjustable) | 25 |
| 203341 | 11306 | Ruffling Blade Lever Bracket (adjustable) 203340 with 202599B..... | 50 |
| 203442 | 11306 | Ruffling Blade Lever Bracket Crank with two each 200098B, 200382c and 202607 | 75 |
| 200382c | 11305 | Ruffling Blade Lever Bracket Crank Set Screw | 02 |
| 200098B | 10438 | Ruffling Blade Lever Bracket Screw.... | 03 |
| 202600 | 11202 | Ruffling Blade Lever Bracket Screw Washer | 01 |
| 200289 | 11202 | Ruffling Blade Lever Hinge Screw..... | 05 |
| 201537 | 11202 | Ruffling Blade Lever Hinge Screw Nut.. | 03 |
| 202598 | 11305 | Ruffling Blade Lever Spring..... | 05 |
| *200771 | --- | Ruffling Blade Lever Spring Stud..... | 1 |
| 202599B | 11305 | Ruffling Blade Lever Spring Stud Bracket with 200771..... | 25 |
| 201566B | 11305 | Ruffling Blade Lever Spring Thumb Nut | 05 |
| 202603 | 11305 | Ruffling Blade Lever Spring Thumb Nut Washer | 01 |
| 202603 | 11305 | Ruffling Blade Lever Spring Washer.... | 01 |
| 202605B | 11306 | Ruffling Blade Lifting Lever..... | 25 |
| 200168c | 11306 | Ruffling Blade Lifting Lever Set Screw | 02 |
| 202606 | 11303 | Ruffling Blade Lifting Lever Stud (adjustable) | 45 |
| 226340 | 11202 | Ruffling Blade Lifting Lever Stud 202606 with 202605B..... | 70 |
| 200072c | 11010 | Ruffling Blade Lifting Lever Pinch Screw | 03 |
| 226666 | 11530 | Ruffling Blade Regulating Lever Shaft.. | 25 |
| 202574 | 11306 | Ruffling Blade Regulating Lever Shaft Collar with 200380c..... | 15 |
| 200380c | 11202 | Ruffling Blade Regulating Lever Shaft Collar Set Screw..... | 02 |
| 226667 | 11530 | Ruffling Blade..... | 50 |

From the library of: Diamond Needle Corp

| No. | Plate | Name | Each |
|--------|-------|---|------|
| 202090 | 10443 | Presser Foot Hinge Pin..... | 01 |
| 226668 | — | Presser Foot Plate..... | 2 25 |
| 202928 | — | Presser Foot Shank..... | 75 |
| 226669 | 11530 | Presser Foot (hinged) (strip guide) complete, Nos. 202090, 202928 and 226668 | 3 00 |
| 211011 | 11358 | Throat Plate (formerly "99 F") 50 needle hole, for needle sizes 3 to 5, made in gauges from $\frac{1}{4}$ in. to $\frac{3}{4}$ in. in steps of $\frac{1}{32}$ in., for 203462 and 211010..... | 1 25 |
| 226670 | — | Ruffling Combination No. 70 complete... | 7 50 |

No. 226677 COMBINATION

(FORMERLY No. 71.)

For Skirt Work for Gathering the Top of a Skirt Before the Band Is Put On or for Laying a Ruffle Having a Selvage Edge on the Face of the Material.

When Ordering, State Gauge Required.

| No. | Plate | Name | Each |
|---------|-------|--|------|
| 211010 | 11355 | Feed Dog (formerly "99") for 211011.... | 60 |
| 226674 | 11531 | Presser Foot with two 200907B..... | 1 00 |
| 226675 | 11531 | Presser Foot 226674 with 226671 to 226673 | 4 00 |
| 226671 | 11531 | Ruffle Guide (adjustable) with two 200174b | 2 00 |
| 200173 | 11215 | Ruffle Guide Screw..... | 04 |
| 226672 | 11531 | Ruffle Guide Bracket with two 200173... | 1 00 |
| 200907B | 11204 | Ruffle Guide Bracket Screw..... | 02 |
| 226673 | 11531 | Ruffling Separating Blade..... | 25 |
| 200174b | 11204 | Ruffling Separating Blade Screw..... | 02 |
| 226676 | 11532 | Ruffling Blade..... | 50 |
| 202610 | 11305 | Ruffling Blade Clamp..... | 02 |
| 200174b | 11204 | Ruffling Blade Clamp Screw..... | 02 |
| 202597 | 11306 | Ruffling Blade Lever with 202610 and two 200174b | 1 25 |
| 202837 | 11218 | Ruffling Blade Lever Bracket with 202599B and two 202602..... | 1 75 |
| 202602 | 11215 | Ruffling Blade Lever Bracket Pin..... | 05 |
| *202973 | — | Ruffling Blade Lever Bracket Position Collar | — |
| *202974 | — | Ruffling Blade Lever Bracket Position Collar Position Pin..... | — |
| 226407 | 11215 | Ruffling Blade Lever Bracket Shaft with 200101b, 202973 and 202974..... | 1 25 |
| 226429 | 11211 | Ruffling Blade Lever Bracket Shaft 226407 with 200289B, 201537, 201566B, 202597, 202598, 202613, 202837 and two 202603 | 4 75 |
| 202613 | 11213 | Ruffling Blade Lever Bracket Spring.... | 03 |
| 200101B | 11305 | Ruffling Blade Lever Bracket Spring Screw | 04 |
| 200289B | 11202 | Ruffling Blade Lever Hinge Screw..... | 05 |
| 201537 | 11202 | Ruffling Blade Lever Hinge Screw Nut.. | 03 |
| 202598 | 11305 | Ruffling Blade Lever Spring..... | 05 |
| 200771 | — | Ruffling Blade Lever Spring Stud..... | — |
| 202599B | 11305 | Ruffling Blade Lever Spring Stud Bracket with 200771..... | 25 |

From the Library of Diana and Needle Corp

| No. | Plate | Name | Each |
|---------|-------|---|------|
| 201566B | 11305 | Ruffling Blade Lever Spring Thumb Nut | 05 |
| 202603 | 11305 | Ruffling Blade Lever Spring Thumb Nut Washer | 01 |
| 202603 | 11305 | Ruffling Blade Lever Spring Washer | 01 |
| 226410 | 11211 | Switching Lever with 200043c, 200162, 200284 and 200909e | 1 60 |
| 226411 | 11211 | Switching Lever 226410 with 203935, 226348 and 226413 | 3 00 |
| 226431 | — | Switching Lever 226411 with 226354 | 4 00 |
| 226347 | 11203 | Switching Lever Bell Crank | 50 |
| 226348 | 11206 | Switching Lever Bell Crank 226347 with 200659c and 201528c | 60 |
| 200909e | 11203 | Switching Lever Bell Crank Hinge Screw | 08 |
| 202668B | 11306 | Switching Lever Bell Crank Slide Block | 15 |
| 200659c | 11203 | Switching Lever Bell Crank Slide Block Screw Stud | 05 |
| 201528c | 11203 | Switching Lever Bell Crank Slide Block Screw Stud Nut | 04 |
| 202104 | 11204 | Switching Lever Bell Crank Slide Block Screw Stud Washer | 01 |
| 226413 | 11215 | Switching Lever Latch | 50 |
| 200284B | 11204 | Switching Lever Latch Hinge Screw | 05 |
| 203935 | 11215 | Switching Lever Latch Spring | 02 |
| 202027 | 11215 | Switching Lever Latch Spring Pin | 01 |
| 200162 | 11203 | Switching Lever Latch Stop Screw | 04 |
| 200043c | 10436 | Switching Lever Pinch Screw | 04 |
| 226353 | 11211 | Switching Lever Shaft | 35 |
| 226354 | 11211 | Switching Lever Shaft 226353 with 226355 and 226356 | 1 00 |
| 202305c | 10436 | Switching Lever Shaft Center | 06 |
| 200043c | 10436 | Switching Lever Shaft Center Set Screw | 04 |
| 226355 | 11211 | Switching Lever Shaft Spring | 30 |
| 226356 | 11204 | Switching Lever Shaft Spring Collar with 200363c | 25 |
| 200363c | 11204 | Switching Lever Shaft Spring Collar Set Screw | 03 |
| 211011 | 11358 | Throat Plate (formerly "99-P") 50 needle hole, for needle sizes 3 to 5, made in gauges $\frac{1}{8}$, $\frac{3}{16}$, $\frac{1}{4}$, $\frac{5}{16}$ and $\frac{3}{8}$ in., for 203462 and 211010 | 1 25 |
| 226677 | — | Ruffling Combination No. 71 complete | 8 50 |

No. 226682 COMBINATION

(FORMERLY No. 72.)

For Skirts and Underwear. Folds a Strip on the Bottom to Cover the Seam, Turns the Edge of the Garment Down, and Places a Ruffle Between Them.

When Ordering, State Gauge Required.

| No. | Plate | Name | Each |
|---------|-------|---|------|
| 226393 | 11214 | Attachment Arm Switch (to the right) with two 200187B | 1 25 |
| 226394 | 11211 | Attachment Arm Switch 226393 with 226397 and 226399 | 2 15 |
| 226395 | 11214 | Attachment Arm Switch Bracket with 200272B, 228032 and two 200911 | 1 25 |
| 226396 | 11211 | Attachment Arm Switch Bracket 226395 with 226394 | 3 35 |
| 200911 | 11213 | Attachment Arm Switch Bracket Screw | 05 |
| 200272B | 11213 | Attachment Arm Switch Hinge Screw | 08 |
| 228032 | 11213 | Attachment Arm Switch Hinge Screw Washer | 01 |
| 226397 | 11213 | Attachment Arm Switch Latch with 200272B and 226398 | 85 |
| 200272B | 11213 | Attachment Arm Switch Latch Hinge Screw | 08 |
| 226398 | 11213 | Attachment Arm Switch Latch Hinge Screw Washer | 01 |
| 226399 | 11213 | Attachment Arm Switch Latch Spring | 05 |
| 211010 | 11355 | Feed Dog (formerly "99") for 211011 | 60 |
| 226678 | 11532 | Folder (lower) and Separating Blade (on shank) | 3 00 |
| 200157B | 11204 | Folder Screw | 05 |
| 226679 | 11532 | Folder (upper) | 2 00 |
| 200183 | 11221 | Folder (upper) Screw | 02 |
| 226681 | 11522 | Guide (on shank) | 1 25 |
| 200187B | 11213 | Guide Screw | 04 |
| 226503 | 11501 | Presser Foot with two 200183 | 1 25 |
| 226680 | 11533 | Presser Foot 226503 with 226679 | 4 75 |
| 226506 | 11502 | Ruffling Blade | 50 |
| 202610 | 11305 | Ruffling Blade Clamp | 02 |
| 200174B | 11204 | Ruffling Blade Clamp Screw | 02 |
| 202597 | 11306 | Ruffling Blade Lever with 202610 and two 200174B | 1 25 |
| 202837 | 11218 | Ruffling Blade Lever Bracket with 202599B and two 202602 | 1 75 |
| 202602 | 11215 | Ruffling Blade Lever Bracket Pin | 05 |

From the library of: Digital Needle Corp.

| No. | Plate | Name | Each |
|---------|-------|--|------|
| *202973 | — | Ruffling Blade Lever Bracket Position Collar | — |
| *202974 | — | Ruffling Blade Lever Bracket Position Collar Position Pin..... | — |
| 226407 | 11215 | Ruffling Blade Lever Bracket Shaft with 200101b, 202973 and 202974..... | 1 25 |
| 226429 | 11211 | Ruffling Blade Lever Bracket Shaft 226407 with 200289b, 201537, 201566b, 202597, 202598, 202613, 202837 and two 202603 | 4 75 |
| 202613 | 11213 | Ruffling Blade Lever Bracket Spring.... | 03 |
| 200101B | 11305 | Ruffling Blade Lever Bracket Spring Screw | 04 |
| 200289B | 11202 | Ruffling Blade Lever Hinge Screw..... | 05 |
| 201537 | 11202 | Ruffling Blade Lever Hinge Screw Nut.. | 03 |
| 202598 | 11305 | Ruffling Blade Lever Spring..... | 05 |
| *200771 | — | Ruffling Blade Lever Spring Stud..... | — |
| 202599B | 11305 | Ruffling Blade Lever Spring Stud Bracket with 200771..... | 25 |
| 201566B | 11305 | Ruffling Blade Lever Spring Thumb Nut | 05 |
| 202603 | 11305 | Ruffling Blade Lever Spring Thumb Nut Washer | 01 |
| 202603 | 11305 | Ruffling Blade Lever Spring Washer.... | 01 |
| 226410 | 11211 | Switching Lever with 200043c, 200162, 200284 and 200909e..... | 1 60 |
| 226411 | 11211 | Switching Lever 226410 with 203935, 226348 and 226413..... | 3 00 |
| 226431 | — | Switching Lever 226411 with 226354.... | 4 00 |
| 226347 | 11203 | Switching Lever Bell Crank..... | 50 |
| 226348 | 11206 | Switching Lever Bell Crank 226347 with 200659c and 201528c..... | 60 |
| 200909E | 11203 | Switching Lever Bell Crank Hinge Screw | 08 |
| 202668 | 11306 | Switching Lever Bell Crank Slide Block | 15 |
| 200659c | 11203 | Switching Lever Bell Crank Slide Block Screw Stud..... | 05 |
| 201528c | 11203 | Switching Lever Bell Crank Slide Block Screw Stud Nut..... | 04 |
| 202104 | 11204 | Switching Lever Bell Crank Slide Block Screw Stud Washer..... | 01 |
| 226413 | 11215 | Switching Lever Latch..... | 50 |
| 200284B | 11204 | Switching Lever Latch Hinge Screw.... | 05 |
| 203935 | 11215 | Switching Lever Latch Spring..... | 02 |
| 202027 | 11215 | Switching Lever Latch Spring Pin..... | 01 |
| 200162 | 11203 | Switching Lever Latch Stop Screw..... | 04 |
| 200043c | 10436 | Switching Lever Pinch Screw..... | 04 |
| 226353 | 11211 | Switching Lever Shaft..... | 35 |
| 226354 | 11211 | Switching Lever Shaft 226353 with 226355 and 226356..... | 1 00 |

| No. | Plate | Name | Each |
|---------|-------|---|-------|
| 202305c | 10436 | Switching Lever Shaft Center..... | 06 |
| 200043c | 10436 | Switching Lever Shaft Center Set Screw | 04 |
| 226355 | 11211 | Switching Lever Shaft Spring..... | 30 |
| 226356 | 11204 | Switching Lever Shaft Spring Collar with 200363c | 25 |
| 200363c | 11204 | Switching Lever Shaft Spring Collar Set Screw | 03 |
| 211011 | 11358 | Throat Plate (formerly "99-F") 50 needle hole, for needle sizes 3 to 5, made in gauges from $\frac{1}{4}$ in. to $\frac{3}{8}$ in. in steps of $\frac{1}{32}$ in., for 203462 and 211010..... | 1 25 |
| 226682 | — | Ruffling Combination No. 72 complete... | 16 00 |

No. 226692 COMBINATION

(FORMERLY No. 73.)

For Putting a Trimming on the Neck of Ladies' Underwear. It
Folds Up the Edge of a Garment and Gathers it at the will
of the Operator Guides a Lace Edge and a Narrow
Ribbon and Stitches an Open Work Strip Over Them.

When Ordering, State Gauge Required.

| No. | Plate | Name | Each |
|---------|-------|---|------|
| 211010 | 11355 | Feed Dog (formerly "99") for 211011.... | 60 |
| 226684 | 11533 | Folder and Separating Blade with two 200173 | 3 00 |
| 200157D | 11204 | Folder and Separating Blade Screw.... | 05 |
| 226691 | 11535 | Folder and Separating Blade 226684 with 226685 | 4 50 |
| 226685 | 11533 | Guide (on shank)..... | 1 50 |
| 200173 | 11215 | Guide Screw..... | 04 |
| 202090 | 10443 | Presser Foot Hinge Pin..... | 01 |
| 226689 | — | Presser Foot Plate..... | 2 50 |
| 202928 | — | Presser Foot Shank..... | 75 |
| 226690 | 11534 | Presser Foot complete, (ribbon guide) Nos. 202090, 202928 and 226689..... | 3 25 |
| 226683 | 11533 | Ruffling Blade Lever with 202610 and two 200174D | 1 25 |
| 226686 | 11529 | Ruffling Blade..... | 50 |
| 226687 | 11532 | Ruffling Blade Lever Bracket..... | 50 |
| 202574 | 11306 | Ruffling Blade Regulating Lever Shaft Collar with 200380C..... | 15 |
| 200380C | 11202 | Ruffling Blade Regulating Lever Shaft Collar Set Screw..... | 02 |
| 226688 | 11534 | Ruffling Blade Lever Bracket 226687 with 201566B, 202598, 226683 and two 202603 | 1 75 |
| 226339 | 11202 | Ruffling Blade Regulating Lever with two 200382C | 1 75 |
| 226345 | 11211 | Switching Lever with 200043C, 200284D, 200907E, 200909E, 226338 and three 200162D | 1 60 |
| 226346 | 11211 | Switching Lever 226345 with 202600, and 226348 to 226352..... | 3 75 |
| 226357 | — | Switching Lever 226346 with 226354.... | 4 75 |
| 226347 | 11203 | Switching Lever Bell Crank..... | 50 |
| 226348 | 11206 | Switching Lever Bell Crank 226347 with 200659C and 201528D..... | 60 |
| 200909E | 11203 | Switching Lever Bell Crank Hinge Screw | 08 |

| No. | Plate | Name | Each |
|---------|-------|--|-------|
| 226349 | 11203 | Switching Lever Bell Crank Slide Block, in place of 202668..... | 25 |
| 200659C | 11203 | Switching Lever Bell Crank Slide Block Screw Stud..... | 05 |
| 201528D | 11203 | Switching Lever Bell Crank Slide Block Screw Stud Nut..... | 04 |
| 202600 | 11202 | Switching Lever Bell Crank Slide Block Screw Stud Washer..... | 01 |
| 226350 | 11201 | Switching Lever Handle..... | 75 |
| 200162D | 11203 | Switching Lever Handle Screw..... | 04 |
| 226351 | 11201 | Switching Lever Latch..... | 75 |
| 200284D | 11204 | Switching Lever Latch Hinge Screw.... | 05 |
| 226352 | 11203 | Switching Lever Latch Spring..... | 05 |
| 200907E | 11204 | Switching Lever Latch Spring..... | 02 |
| 200162D | 11203 | Switching Lever Latch Stop Screw..... | 04 |
| 200043C | 10436 | Switching Lever Pinch Screw..... | 04 |
| 226353 | 11211 | Switching Lever Shaft..... | 35 |
| 226354 | 11211 | Switching Lever Shaft 226353 with 226355 and 226356..... | 1 00 |
| 202305C | 10436 | Switching Lever Shaft Center..... | 06 |
| 200043C | 10436 | Switching Lever Shaft Center Set Screw | 04 |
| 226355 | 11211 | Switching Lever Shaft Spring..... | 30 |
| 226356 | 11204 | Switching Lever Shaft Spring Collar with 200363C | 25 |
| 200363C | 11204 | Switching Lever Shaft Spring Collar Set Screw | 03 |
| 211011 | 11358 | Throat Plate (formerly "99-F") 50 needle hole, for needle sizes 3 to 5, made in gauges $\frac{1}{8}$, $\frac{3}{16}$, $\frac{1}{4}$, $\frac{5}{16}$ and $\frac{3}{8}$ in., for 203462 211010 | 1 25 |
| 226692 | — | Ruffling Combination No. 73 complete... | 13 00 |

From the library of: Diamond Needle Corp.

No. 226698 COMBINATION

(FORMERLY No. 74.)

For Skirt Work. Turns Up the Bottom of Skirt and Turns Down the Ruffle and Folds a Strip for Heading.

When Ordering, State Gauge Required.

| No. | Plate | Name | Each |
|---------|-------|--|------|
| 226393 | 11214 | Attachment Arm Switch (to the right) with two 200187B..... | 1 25 |
| 226394 | 11214 | Attachment Arm Switch 226393 with 226397 and 226399..... | 2 15 |
| 226395 | 11214 | Attachment Arm Switch Bracket with 200272B, 228032 and two 200911..... | 1 25 |
| 226396 | 11211 | Attachment Arm Switch Bracket 226395 with 226394..... | 3 35 |
| 200911 | 11213 | Attachment Arm Switch Bracket Screw.. | 05 |
| 200272B | 11213 | Attachment Arm Switch Hinge Screw... | 08 |
| 228032 | 11213 | Attachment Arm Switch Hinge Screw Washer | 01 |
| 226397 | 11213 | Attachment Arm Switch Latch with 200272B and 226398..... | 85 |
| 200272B | 11213 | Attachment Arm Switch Latch Hinge Screw | 08 |
| 226398 | 11213 | Attachment Arm Switch Latch Hinge Screw Washer..... | 01 |
| 226399 | 11213 | Attachment Arm Switch Latch Spring... | 05 |
| 211030 | 11356 | Feed Dog (formerly "134") for 211028 and 211029 | 75 |
| 226693 | 11536 | Folder (lower) (plate) with 200305..... | 2 00 |
| 200157B | 11204 | Folder (lower) Screw..... | 05 |
| 226696 | 11536 | Folder 226693 with 226694 and 226695... | 3 00 |
| 226697 | 11522 | Folder (upper) on shank..... | 2 00 |
| 200187B | 11213 | Folder (upper) Screw..... | 04 |
| 226542 | 11507 | Presser Foot (strip folder)..... | 2 50 |
| 226694 | 11534 | Ruffling Separating Blade (switch)..... | 25 |
| 200183 | 11221 | Ruffling Separating Blade Screw..... | 02 |
| 226695 | 11534 | Ruffling Separating Blade Switching Lever with two 200183..... | 60 |
| 226506 | 11502 | Ruffling Blade..... | 50 |
| 202610 | 11305 | Ruffling Blade Clamp..... | 02 |
| 200174D | 11204 | Ruffling Blade Clamp Screw..... | 02 |
| 202597 | 11306 | Ruffling Blade Lever with 202610 and two 200174D | 1 25 |
| *226403 | — | Ruffling Blade Lever Bracket (adjustable) | 25 |
| 226404 | 11213 | Ruffling Blade Lever Bracket (adjustable) 226403 with 202599B..... | 50 |

| No. | Plate | Name | Each |
|---------|-------|--|------|
| 226415 | 11216 | Ruffling Blade Lever Bracket 226404 with 200289, 201537, 201566B, 202597, 202598 and two 202603..... | 1 85 |
| 226405 | 11213 | Ruffling Blade Lever Bracket Crank with two each 200098B, 202600 and 202602.. | 1 00 |
| 226406 | 11211 | Ruffling Blade Lever Bracket Crank 226405 with 202613 and 226407..... | 2 25 |
| 202602 | 11215 | Ruffling Blade Lever Bracket Crank Position Pin..... | 05 |
| 202613 | 11213 | Ruffling Blade Lever Bracket Crank Spring | 03 |
| 200191D | 11305 | Ruffling Blade Lever Bracket Crank Spring Screw..... | 04 |
| *202973 | — | Ruffling Blade Lever Bracket Position Collar | — |
| *202974 | — | Ruffling Blade Lever Bracket Position Collar Position Pin..... | — |
| 200098B | 10138 | Ruffling Blade Lever Bracket Screw.... | 03 |
| 202600 | 11202 | Ruffling Blade Lever Bracket Screw Washer | 01 |
| 226407 | 11215 | Ruffling Blade Lever Bracket Shaft with 200191D, 202973 and 202974..... | 2 25 |
| 226408 | 11211 | Ruffling Blade Lever Bracket Shaft with 226406 and 226415..... | 2 00 |
| 200289 | 11202 | Ruffling Blade Lever Hinge Screw..... | 05 |
| 201537 | 11202 | Ruffling Blade Lever Hinge Screw Nut.. | 03 |
| 202598 | 11305 | Ruffling Blade Lever Spring..... | 05 |
| 200771 | — | Ruffling Blade Lever Spring Stud..... | — |
| 202599B | 11305 | Ruffling Blade Lever Spring Stud Bracket with 200771..... | 25 |
| 201566B | 11305 | Ruffling Blade Lever Spring Thumb Nut | 05 |
| 202603 | 11305 | Ruffling Blade Lever Spring Thumb Nut Washer | 01 |
| 202603 | 11305 | Ruffling Blade Lever Spring Washer.... | 01 |
| 226409 | 11213 | Stop Block..... | 35 |
| 226410 | 11211 | Switching Lever with 200043C, 200162, 200284 and 200909E..... | 1 60 |
| 226411 | 11211 | Switching Lever 226410 with 203935, 226412 and 226413..... | 3 00 |
| 226431 | — | Switching Lever 226411 with 226354..... | 4 00 |
| 226347 | 11203 | Switching Lever Bell Crank..... | 50 |
| 226348 | 11206 | Switching Lever Bell Crank 226347 with 200659C and 201528D..... | 60 |
| 200909E | 11203 | Switching Lever Bell Crank Hinge Screw | 08 |
| 202668 | 11306 | Switching Lever Bell Crank Slide Block | 15 |
| 200659C | 11203 | Switching Lever Bell Crank Slide Block Screw Stud..... | 05 |
| 201528D | 11203 | Switching Lever Bell Crank Slide Block Screw Stud Nut..... | 04 |
| 02104 | 11204 | Switching Lever Bell Crank Slide Block Screw Stud Washer..... | 01 |

From the library of: Diamond Needle Corp

| No. | Plate | Name | Each |
|---------|-------|---|-------|
| 226413 | 11215 | Switching Lever Latch..... | 50 |
| 200284B | 11204 | Switching Lever Latch Hinge Screw.... | 05 |
| 203935 | 11215 | Switching Lever Latch Spring..... | 02 |
| 202027 | 11215 | Switching Lever Latch Spring Pin..... | 01 |
| 200162D | 11203 | Switching Lever Latch Stop Screw..... | 04 |
| 200043C | 10436 | Switching Lever Pinch Screw..... | 04 |
| 226353 | 11211 | Switching Lever Shaft..... | 35 |
| 226354 | 11211 | Switching Lever Shaft 226353 with 226355 | 1 00 |
| 202305C | 10436 | Switching Lever Shaft Center..... | 06 |
| 200043C | 10436 | Switching Lever Shaft Center Set Screw | 04 |
| 226355 | 11211 | Switching Lever Shaft Spring..... | 30 |
| 226356 | 11204 | Switching Lever Shaft Spring Collar with 200363C | 25 |
| 200363C | 11204 | Switching Lever Shaft Spring Collar Set Screw | 03 |
| 211028 | 11356 | Throat Plate (formerly "134-P") 50 needle hole, for needle sizes 3 to 5, made in gauges 1, 2, 3, 4, 5, 6, 7, 8 and 7/8 in., for 203462 and 211030..... | 1 25 |
| 211029 | 11356 | Throat Plate (formerly "134-P") 46 needle hole, for needle sizes 5 to 7, made in gauges 1, 2, 3, 4, 5, 6, 7, 8 and 7/8 in., for 203462 and 211030..... | 1 25 |
| 226698 | — | Ruffling Combination No. 74 complete... | 20 00 |

No. 226702 COMBINATION

(FORMERLY No. 75)

For Ladies' Underwear. Folds and Ruffles the Edge of the
Garment, Inserts a Puckering Tape and Folds a Strip
For a Heading.

When Ordering, State Gauge Required.

| No. | Plate | Name | Each |
|---------|-------|--|------|
| 211035 | 11357 | Feed Dog (formerly "41") for 211033 and 211034 | 85 |
| 226699 | 11535 | Folder (on shank)..... | 2 50 |
| 200157B | 11204 | Folder (on shank) Screw..... | 05 |
| 226700 | 11535 | Ruffling Blade..... | 05 |
| 202610 | 11305 | Ruffling Blade Clamp..... | 02 |
| 200174D | 11204 | Ruffling Blade Clamp Screw..... | 02 |
| 202597 | 11306 | Ruffling Blade Lever with 202610 and two 200174D | 1 25 |
| 226404 | 11213 | Ruffling Blade Lever Bracket (adjust- able) | 50 |
| 226415 | 11216 | Ruffling Blade Lever Bracket 226404 with 200289, 201537, 201566B, 202597, 202598 and two 202603..... | 1 85 |
| 226513 | 11502 | Ruffling Blade Lever Bracket Crank with two each 200098B, 200382C and 202600 | 75 |
| 200382C | 11305 | Ruffling Blade Lever Bracket Crank Set Screw | 08 |
| 200098B | 10438 | Ruffling Blade Lever Bracket Screw.... | 03 |
| 202600 | 11202 | Ruffling Blade Lever Bracket Screw Washer | 04 |
| 200289 | 11202 | Ruffling Blade Lever Hinge Screw..... | 05 |
| 201537 | 11202 | Ruffling Blade Lever Hinge Screw Nut.. | 03 |
| 202598 | 11305 | Ruffling Blade Lever Spring..... | 05 |
| 202599B | 11305 | Ruffling Blade Lever Spring Stud Bracket | 25 |
| 226514 | 11502 | Ruffling Blade Lifting Lever..... | 25 |
| 226701 | 11536 | Presser Foot (strip folder and puckering tape guide)..... | 3 50 |
| 226410 | 11211 | Switching Lever with 200043C, 200162, 200284 and 200909E..... | 1 60 |
| 226411 | 11211 | Switching Lever 226410 with 203935, 226412 and 226413..... | 3 00 |
| 226431 | — | Switching Lever 226411 with 226354..... | 4 00 |
| 226347 | 11203 | Switching Lever Bell Crank..... | 50 |
| 226348 | 11206 | Switching Lever Bell Crank 226347 with 200659C and 201528D..... | 60 |
| 200909C | 11203 | Switching Lever Bell Crank Hinge Screw | 08 |
| 202668 | 11306 | Switching Lever Bell Crank Slide Block | 15 |

Copyright © 2013 by The Library of Congress

| No. | Plate | Name | Each |
|---------|-------|--|-------|
| 200659c | 11203 | Switching Lever Bell Crank Slide Block Screw Stud..... | 05 |
| 201528c | 11203 | Switching Lever Bell Crank Slide Block Screw Stud Nut..... | 04 |
| 202104 | 11204 | Switching Lever Bell Crank Slide Block Screw Stud Washer..... | 01 |
| 226413 | 11215 | Switching Lever Latch..... | 50 |
| 200284b | 11204 | Switching Lever Latch Hinge Screw.... | 05 |
| 203935 | 11215 | Switching Lever Latch Spring..... | 02 |
| 202027 | 11215 | Switching Lever Latch Spring Pin..... | 01 |
| 200162b | 11203 | Switching Lever Latch Stop Screw..... | 04 |
| 200043c | 10436 | Switching Lever Pinch Screw..... | 04 |
| 226353 | 11211 | Switching Lever Shaft..... | 35 |
| 226354 | 11211 | Switching Lever Shaft 226353 with 226355 and 226356..... | 1 00 |
| 202305c | 10436 | Switching Lever Shaft Center..... | 06 |
| 200043c | 10436 | Switching Lever Shaft Center Set Screw | 04 |
| 226355 | 11211 | Switching Lever Shaft Spring..... | 30 |
| 226356 | 11204 | Switching Lever Shaft Spring Collar with 200363c | 25 |
| 200363c | 11204 | Switching Lever Shaft Spring Collar Set Screw | 03 |
| 211033 | 11357 | Throat Plate (formerly "41-F") 50 needle hole, for needle sizes 3 to 5, made in gauges $\frac{3}{8}$, $\frac{3}{16}$, $\frac{1}{8}$, $\frac{3}{32}$ and $\frac{1}{4}$ in., for 203462 and 211035..... | 1 50 |
| 211034 | 11357 | Throat Plate (formerly "41-F") 46 needle hole, for needle sizes 5 to 7, made in gauges $\frac{3}{8}$, $\frac{3}{16}$, $\frac{1}{8}$, $\frac{3}{32}$ and $\frac{1}{4}$ in., for 203462 and 211035..... | 1 50 |
| 226702 | — | Ruffling Combination No. 75 complete... | 11 50 |

No. 226709 COMBINATION

(FORMERLY No. 76.)

For Corset Covers. Gathers the Corset Cover at will of Operator, Guides a Folded Strip on the Bottom and a Tape or Puckering String Between Them.

When Ordering, State Gauge Required.

| No. | Plate | Name | Each |
|---------|-------|--|------|
| 211010 | 11355 | Feed Dog (formerly "99") for 211021..... | 60 |
| 226708 | 11537 | Presser Foot..... | 1 00 |
| 226704 | 11537 | Ruffling Blade..... | 50 |
| 226705 | 11537 | Ruffling Separating Blade..... | 50 |
| 226706 | 11537 | Ruffling Separating Blade Bracket with two 200174b..... | 50 |
| 202610 | 11305 | Ruffling Blade Clamp..... | 02 |
| 200174b | 11204 | Ruffling Blade Clamp Screw..... | 02 |
| 202597 | 11306 | Ruffling Blade Lever with 202610 and two 200174b | 1 25 |
| 202837 | 11218 | Ruffling Blade Lever Bracket with 202599b and two 202602..... | 1 75 |
| 202602 | 11215 | Ruffling Blade Lever Bracket Pin..... | 05 |
| *202973 | — | Ruffling Blade Lever Bracket Position Collar | — |
| *202974 | — | Ruffling Blade Lever Bracket Position Collar Position Pin..... | — |
| 226407 | 11215 | Ruffling Blade Lever Bracket Shaft with 200101b, 202973 and 202974..... | 1 25 |
| 226429 | 11211 | Ruffling Blade Lever Bracket Shaft 226407 with 200289b, 201537, 201566b, 202597, 202598, 202613, 202837 and two 202603 | 4 75 |
| 202613 | 11213 | Ruffling Blade Lever Bracket Spring.... | 03 |
| 200101b | 11305 | Ruffling Blade Lever Bracket Spring Screw | 04 |
| 200289b | 11202 | Ruffling Blade Lever Hinge Screw..... | 05 |
| 201537 | 11202 | Ruffling Blade Lever Hinge Screw Nut.. | 03 |
| 202598 | 11305 | Ruffling Blade Lever Spring..... | 05 |
| *200771 | — | Ruffling Blade Lever Spring Stud..... | — |
| 202599b | 11305 | Ruffling Blade Lever Spring Stud Bracket with 200771..... | 25 |
| 201566b | 11305 | Ruffling Blade Lever Spring Thumb Nut | 05 |
| 202603 | 11305 | Ruffling Blade Lever Spring Thumb Nut Washer | 01 |
| 202603 | 11305 | Ruffling Blade Lever Spring Washer.... | 01 |
| 226410 | 11211 | Switching Lever with 200043c, 200162, 200284 and 200909e..... | 1 60 |
| 226411 | 11211 | Switching Lever 226410 with 203935, 226348 and 226413..... | 3 00 |

From the library of: Diamond Needle Corp

| No. | Plate | Name | Each |
|---------|-------|--|-------|
| 226431 | — | Switching Lever 226411 with 226354.... | 4 00 |
| 226347 | 11203 | Switching Lever Bell Crank..... | 50 |
| 226348 | 11206 | Switching Lever Bell Crank 226347 with 200659c and 201528b..... | 60 |
| 200909E | 11203 | Switching Lever Bell Crank Hinge Screw | 08 |
| 202668 | 11306 | Switching Lever Bell Crank Slide Block | 15 |
| 200659c | 11203 | Switching Lever Bell Crank Slide Block Screw Stud..... | 05 |
| 201528c | 11203 | Switching Lever Bell Crank Slide Block Screw Stud Nut..... | 04 |
| 202104 | 11204 | Switching Lever Bell Crank Slide Block Screw Stud Washer..... | 01 |
| 226413 | 11215 | Switching Lever Latch..... | 50 |
| 200284B | 11204 | Switching Lever Latch Hinge Screw..... | 05 |
| 203935 | 11215 | Switching Lever Latch Spring..... | 02 |
| 202027 | 11215 | Switching Lever Latch Spring Pin..... | 01 |
| 200162D | 11203 | Switching Lever Latch Stop Screw.... | 04 |
| 200043c | 10436 | Switching Lever Pinch Screw..... | 04 |
| 226353 | 11211 | Switching Lever Shaft..... | 35 |
| 226354 | 11211 | Switching Lever Shaft 226353 with 226355 and 226356..... | 1 00 |
| 202305c | 10436 | Switching Lever Shaft Center..... | 06 |
| 200043c | 10436 | Switching Lever Shaft Center Set Screw | 04 |
| 226355 | 11211 | Switching Lever Shaft Spring..... | 30 |
| 226356 | 11204 | Switching Lever Shaft Spring Collar with 200363c..... | 25 |
| 200363c | 11204 | Switching Lever Shaft Spring Collar Set Screw..... | 03 |
| 226703 | 11537 | Tape Guide (plate) with 200170..... | 2 00 |
| 226707 | 11538 | Tape Guide 226703 with 226705 and 226706 | 3 00 |
| 200157B | 11204 | Tape Guide Screw..... | 05 |
| 211021 | 11354 | Throat Plate (formerly "22-F") 50 needle hole, for needle sizes 3 to 5, made in gauges from $\frac{1}{4}$ in. to $\frac{1}{8}$ in. in steps of $\frac{1}{32}$ in., for 203462 and 211010..... | 1 25 |
| 226709 | — | Ruffling Combination No. 76 complete.... | 11 00 |

No. 226478 COMBINATION

(FORMERLY No. 77)

For Skirt and Petticoat Manufacture (has a Folder and Three Guides). Folds the Edge of the Flounce, Guides the Ruffle and Piping, also Guides the Skirt.

| No. | Plate | Name | Each |
|---------|-------|---|------|
| 226463 | 11223 | Attachment Arm Switch with two 200183B..... | 1 00 |
| 226464 | 11223 | Attachment Arm Switch Bracket with 200268B, 200336D, 201531, 201537 and 226467..... | 1 50 |
| 226465 | 11224 | Attachment Arm Switch Bracket 226464 with 226463..... | 2 50 |
| 200157B | 11204 | Attachment Arm Switch Bracket Screw | 05 |
| 200268B | 11223 | Attachment Arm Switch Hinge Screw.. | 10 |
| 201531 | 11223 | Attachment Arm Switch Hinge Screw Nut..... | 03 |
| 226467 | 11223 | Attachment Arm Switch Hinge Screw Spring Washer..... | 05 |
| 200336D | 10441 | Attachment Arm Switch Stop Screw.... | 04 |
| 201537 | 11202 | Attachment Arm Switch Stop Screw Check Nut..... | 03 |
| 226468 | 11223 | Attachment Arm Switch Strip Guide (on shank)..... | 50 |
| 200183D | 11221 | Attachment Arm Switch Strip Guide Screw..... | 02 |
| 226469 | 11225 | Bed Switch with two 200183B..... | 60 |
| 226471 | 11225 | Bed Switch Guide and Separating Blade (on shank)..... | 75 |
| 200183B | 11221 | Bed Switch Guide and Separating Blade Screw..... | 02 |
| 200305B | 11204 | Bed Switch Hinge Screw..... | 04 |
| 226472 | 11225 | Bed Switch Locking Plate and Folder.. | 2 25 |
| 226473 | 11224 | Bed Switch Locking Plate and Folder 226472 with 226469 and 226471..... | 3 50 |
| 200157B | 11204 | Bed Switch Locking Plate and Folder Screw..... | 05 |
| 211006 | 11350 | Feed Dog (formerly "26-F") for 211003.. | 75 |
| 226474 | 11226 | Presser Foot with two 200164B..... | 1 00 |
| 226475 | 11219 | Presser Foot 226474 with 226476..... | 2 50 |
| 226476 | 11226 | Presser Foot Guide..... | 1 50 |
| 200164B | 11208 | Presser Foot Guide Screw..... | 02 |
| 226477 | 11226 | Ruffling Blade..... | 35 |
| 202610 | 11305 | Ruffling Blade Clamp..... | 02 |

From the library of: Diamond Needle Corp

| No. | Plate | Name | Each |
|---------|-------|--|------|
| 200174D | 11204 | Ruffling Blade Clamp Screw..... | 02 |
| 202597 | 11306 | Ruffling Blade Lever with 202610 and two 200174D..... | 1 25 |
| 202837 | 11218 | Ruffling Blade Lever Bracket with 202599B and two 202602..... | 1 75 |
| 202602 | 11215 | Ruffling Blade Lever Bracket Pin..... | 05 |
| *202973 | — | Ruffling Blade Lever Bracket Position Collar | — |
| *202974 | — | Ruffling Blade Lever Bracket Position Collar Position Pin..... | — |
| 226407 | 11215 | Ruffling Blade Lever Bracket Shaft with 200101B, 202973 and 202974..... | 1 25 |
| 226429 | 11211 | Ruffling Blade Lever Bracket Shaft 226407 with 200289B, 201537, 201566B, 202597, 202598, 202613, 202837 and two 202603.. | 4 75 |
| 202613 | 11213 | Ruffling Blade Lever Bracket Spring.... | 03 |
| 200101B | 11305 | Ruffling Blade Lever Bracket Spring Screw | 04 |
| 200289B | 11202 | Ruffling Blade Lever Hinge Screw..... | 05 |
| 201537 | 11202 | Ruffling Blade Lever Hinge Screw Nut.. | 03 |
| 202598 | 11305 | Ruffling Blade Lever Spring..... | 05 |
| *200771 | — | Ruffling Blade Lever Spring Stud..... | — |
| 202599B | 11305 | Ruffling Blade Lever Spring Stud Bracket with 200771..... | 25 |
| 201566B | 11305 | Ruffling Blade Lever Spring Thumb Nut | 05 |
| 202603 | 11305 | Ruffling Blade Lever Spring Thumb Nut Washer | 01 |
| 202603 | 11305 | Ruffling Blade Lever Spring Washer.... | 01 |
| 226410 | 11211 | Switching Lever with 200043C, 200162, 200284 and 200909E..... | 1 60 |
| 226411 | 11211 | Switching Lever 226410 with 203935, 226348 and 226413..... | 3 00 |
| 226431 | — | Switching Lever 226411 with 226354..... | 4 00 |
| 226347 | 11203 | Switching Lever Bell Crank..... | 50 |
| 226348 | 11206 | Switching Lever Bell Crank 226347 with 200659C and 201528C..... | 60 |
| 200909E | 11203 | Switching Lever Bell Crank Hinge Screw | 08 |
| 202668 | 11306 | Switching Lever Bell Crank Slide Block | 15 |
| 200659C | 11203 | Switching Lever Bell Crank Slide Block Screw Stud..... | 05 |
| 201528C | 11203 | Switching Lever Bell Crank Slide Block Screw Stud Nut..... | 04 |
| 202104 | 11204 | Switching Lever Bell Crank Slide Block Screw Stud Washer..... | 01 |
| 226413 | 11215 | Switching Lever Latch..... | 50 |
| 200284B | 11204 | Switching Lever Latch Hinge Screw.... | 05 |
| 203935 | 11215 | Switching Lever Latch Spring..... | 02 |

| No. | Plate | Name | Each |
|---------|-------|---|-------|
| 202027 | 11215 | Switching Lever Latch Spring Pin..... | 01 |
| 200162 | 11203 | Switching Lever Latch Stop Screw..... | 04 |
| 200043C | 10436 | Switching Lever Pinch Screw..... | 04 |
| 226353 | 11211 | Switching Lever Shaft..... | 35 |
| 226354 | 11211 | Switching Lever Shaft 226353 with 226355 and 226356..... | 1 00 |
| 202305C | 10436 | Switching Lever Shaft Center..... | 06 |
| 200043C | 10436 | Switching Lever Shaft Center Set Screw | 04 |
| 226355 | 11211 | Switching Lever Shaft Spring..... | 30 |
| 226356 | 11201 | Switching Lever Shaft Spring Collar with 200363C | 25 |
| 200363C | 11204 | Switching Lever Shaft Spring Collar Set Screw | 03 |
| 211003 | 11350 | Throat Plate (formerly "21-12-F") 50 needle hole, for needle sizes 3 to 5, for 203253 and 211006..... | 1 00 |
| 226478 | — | Ruffling Combination No. 77 complete... | 18 50 |

No. 226714 COMBINATION

(FORMERLY No. 78.)

For Skirt and Petticoat Manufacture. Turns Up the Bottom of the Skirt, Folds a Strip on Top and Guides a Ruffle Between Them.

When Ordering, State Gauge Required.

| No. | Plate | Name | Each |
|---------|-------|---|----------|
| 226393 | 11214 | Attachment Arm Switch (to the right) with two 200187B..... | 1 25 |
| 226394 | 11214 | Attachment Arm Switch 226393 with 226397 and 226399..... | 2 15 |
| 226395 | 11214 | Attachment Arm Switch Bracket with 200272B, 228032 and two 200911.. | 1 25 |
| 226396 | 11211 | Attachment Arm Switch Bracket 226395 with 226394..... | 3 35 |
| 200911 | 11213 | Attachment Arm Switch Bracket Screw.. | 05 |
| 200272B | 11213 | Attachment Arm Switch Hinge Screw... | 08 |
| 228032 | 11213 | Attachment Arm Switch Hinge Screw Washer | 01 |
| 226397 | 11213 | Attachment Arm Switch Latch with 200272B and 226398..... | 85 |
| 200272B | 11213 | Attachment Arm Switch Hinge Screw... | 08 |
| 226398 | 11213 | Attachment Arm Switch Hinge Screw Washer | 01 |
| 226399 | 11213 | Attachment Arm Switch Latch Spring... Spring | 05 05 |
| 211010 | 11355 | Feed Dog (formerly "99") for 211011.... | 60 |
| 226693 | 11536 | Folder (lower) (plate) with 200305..... | 2 00 |
| 226696 | 11536 | Folder 226693 with 226694 and 226695.... | 3 00 |
| 200157B | 11204 | Folder (lower) Screw..... | 05 |
| 226710 | 11538 | Guide (on shank)..... | 1 00 |
| 226423 | 11215 | Guide Bracket (intermediate) with two 200173 | 60 |
| 226711 | 11522 | Guide Bracket 226423 with 226710..... | 1 60 |
| 200187B | 11213 | Guide Bracket Screw..... | 04 |
| 200173 | 11215 | Guide Screw..... | 04 |
| 202090 | 10443 | Presser Foot Hinge Pin..... | 01 |
| 226712 | — | Presser Foot Plate..... | 2 90 |
| 202928 | — | Presser Foot Shank..... | 75 |
| 226713 | 11538 | Presser Foot (strip folder) Hinged complete, Nos. 202090, 202928 and 226712.. | 3 50 |

| No. | Plate | Name | Each |
|---------|-------|--|------|
| 226694 | 11534 | Ruffling Separating Blade (switch)..... | 25 |
| 200183 | 11221 | Ruffling Separating Blade Screw..... | 02 |
| 226695 | 11534 | Ruffling Separating Blade Switching Lever with two 200183..... | 60 |
| 226506 | 11502 | Ruffling Blade..... | 50 |
| 202610 | 11305 | Ruffling Blade Clamp..... | 02 |
| 200174D | 11204 | Ruffling Blade Clamp Screw..... | 02 |
| 202597 | 11306 | Ruffling Blade Lever with 202610 and two 200174D | 1 25 |
| 202837 | 11218 | Ruffling Blade Lever Bracket with 202599B and two 202602..... | 1 75 |
| 202602 | 11215 | Ruffling Blade Lever Bracket Pin..... | 05 |
| *202973 | — | Ruffling Blade Lever Bracket Position Collar | — |
| *202974 | — | Ruffling Blade Lever Bracket Position Collar Position Pin..... | — |
| 226407 | 11215 | Ruffling Blade Lever Bracket Shaft with 200101B, 202973 and 202974..... | 1 25 |
| 226429 | 11211 | Ruffling Blade Lever Bracket Shaft 226407 with 200289B, 201537, 201566B, 202597, 202598, 202613, 202837 and two 202603 | 4 75 |
| 202613 | 11213 | Ruffling Blade Lever Bracket Spring.... | 05 |
| 200101B | 11305 | Ruffling Blade Lever Bracket Spring Screw | 04 |
| 200289B | 11202 | Ruffling Blade Lever Hinge Screw..... | 05 |
| 201537 | 11202 | Ruffling Blade Lever Hinge Screw Nut.. | 05 |
| 202598 | 11305 | Ruffling Blade Lever Spring..... | 05 |
| 200771 | — | Ruffling Blade Lever Spring Stud..... | — |
| 202599B | 11305 | Ruffling Blade Lever Spring Stud Bracket with 200771..... | 25 |
| 201566B | 11305 | Ruffling Blade Lever Spring Thumb Nut | 05 |
| 202603 | 11305 | Ruffling Blade Lever Spring Thumb Nut Washer | 01 |
| 202603 | 11305 | Ruffling Blade Lever Spring Washer.... | 01 |
| 26410 | 11211 | Switching Lever with 200043C, 200162, 200284 and 200909E..... | 1 60 |
| 26411 | 11211 | Switching Lever 226410 with 203935, 226348 and 226413..... | 3 00 |
| 26431 | — | Switching Lever 226411 with 226354.... | 4 00 |
| 26347 | 11203 | Switching Lever Bell Crank..... | 50 |
| 26348 | 11206 | Switching Lever Bell Crank 226347 with 200659C and 201528C..... | 60 |
| 20909E | 11203 | Switching Lever Bell Crank Hinge Screw | 08 |

| No. | Plate | Name | Each |
|---------|-------|---|-------|
| 202668 | 11306 | Switching Lever Bell Crank Slide Block | 15 |
| 200659c | 11203 | Switching Lever Bell Crank Slide Block Screw Stud..... | 05 |
| 201528c | 11203 | Switching Lever Bell Crank Slide Block Screw Stud Nut..... | 04 |
| 202104 | 11204 | Switching Lever Bell Crank Slide Block Screw Stud Washer..... | 01 |
| 226413 | 11215 | Switching Lever Latch..... | 50 |
| 200284b | 11204 | Switching Lever Latch Hinge Screw.... | 05 |
| 203935 | 11215 | Switching Lever Latch Spring..... | 02 |
| 202027 | 11215 | Switching Lever Latch Spring Pin..... | 01 |
| 200162 | 11203 | Switching Lever Latch Stop Screw.... | 04 |
| 200043c | 10436 | Switching Lever Pinch Screw..... | 04 |
| 226353 | 11211 | Switching Lever Shaft..... | 35 |
| 226354 | 11211 | Switching Lever Shaft 226353 with 226355 and 226356..... | 1 00 |
| 202305c | 10436 | Switching Lever Shaft Center..... | 06 |
| 200043c | 10436 | Switching Lever Shaft Center Set Screw | 04 |
| 226355 | 11211 | Switching Lever Shaft Spring..... | 30 |
| 226356 | 11204 | Switching Lever Shaft Spring Collar with 200363c..... | 25 |
| 200363c | 11204 | Switching Lever Shaft Spring Collar Set Screw | 03 |
| 211011 | 11358 | Throat Plate (formerly "99-F") 50 needle hole, for needle sizes 3 to 5, made in gauges $\frac{1}{4}$, $\frac{3}{8}$, $\frac{1}{2}$, $\frac{5}{8}$ and $\frac{3}{4}$ in., for 203462 and 211010..... | 1 25 |
| 226714 | — | Ruffling Combination No. 78 complete... | 20 00 |

No. 226719 COMBINATION

(FORMERLY No. 79)

For Kimona Work. Guides Two Narrow Tapes or Stays on the
Bottom to Hold the Gathers and Stitches the Garment
Onto Them.

When Ordering, State Gauge Required.

| No. | Plate | Name | Each |
|---------|-------|---|------|
| 211041 | 11358 | Feed Dog (formerly "10-F") for 211039 and 211010..... | 85 |
| 226718 | 11539 | Presser Foot..... | 1 50 |
| 226715 | 11535 | Ruffling Blade..... | 75 |
| 202610 | 11305 | Ruffling Blade Clamp..... | 02 |
| 200174b | 11204 | Ruffling Blade Clamp Screw..... | 02 |
| 203336 | 11306 | Ruffling Blade Driving Lever..... | 1 10 |
| 203337 | 11304 | Ruffling Blade Driving Lever 203336 with 200101b, 203338 and 203339..... | 1 25 |
| 203338 | 11306 | Ruffling Blade Driving Lever Shaft..... | 15 |
| 202574 | 11306 | Ruffling Blade Driving Lever Shaft Collar with two 200380c..... | 15 |
| 200380c | 11202 | Ruffling Blade Driving Lever Shaft Collar Set Screw..... | 02 |
| 203339 | 11306 | Ruffling Blade Driving Lever Shaft Posi- tion Pin..... | 02 |
| 202668 | 11306 | Ruffling Blade Driving Lever Slide Block | 15 |
| 202597 | 11306 | Ruffling Blade Lever with 202610 and two 200174b | 1 25 |
| 203340 | 11202 | Ruffling Blade Lever Bracket (adjust- able) | 25 |
| 203341 | 11306 | Ruffling Blade Lever Bracket (adjust- able) 203340 with 202599B..... | 50 |
| 203342 | 11306 | Ruffling Blade Lever Bracket Crank with two each 200098B, 200382c and 202607 | 75 |
| 200382c | 11305 | Ruffling Blade Lever Bracket Crank Set Screw | 02 |
| 200098B | 10438 | Ruffling Blade Lever Bracket Screw.... | 03 |
| 202600 | 11202 | Ruffling Blade Lever Bracket Screw Washer | 01 |
| 00289 | 11202 | Ruffling Blade Lever Hinge Screw..... | 05 |
| 01537 | 11202 | Ruffling Blade Lever Hinge Screw Nut... | 03 |
| 02598 | 11305 | Ruffling Blade Lever Spring..... | 05 |
| 00771 | — | Ruffling Blade Lever Spring Stud..... | — |
| 02599B | 11305 | Ruffling Blade Lever Spring Stud Bracket with 200771..... | 25 |

From the library of: Diamond Needle Corp

| No. | Plate | Name | Each |
|---------|-------|--|------|
| 201566B | 11305 | Ruffling Blade Lever Spring Thumb Nut | 05 |
| 202603 | 11305 | Ruffling Blade Lever Spring Thumb Nut Washer | 01 |
| 202605 | 11306 | Ruffling Blade Lifting Lever..... | 25 |
| 200168c | 11306 | Ruffling Blade Lifting Lever Set Screw.. | 02 |
| 202606 | 11306 | Ruffling Blade Lifting Lever Stud (adjustable) | 45 |
| 200072c | 11010 | Ruffling Blade Lifting Lever Pinch Screw | 03 |
| 202607 | 11307 | Ruffling Blade Regulating Lever with two 200382c | 1 50 |
| 202608 | 11303 | Ruffling Blade Regulating Lever Index Slide | 25 |
| 200157B | 11204 | Ruffling Blade Regulating Lever Index Slide Stop Screw..... | 05 |
| 203349 | 11307 | Ruffling Blade Regulating Lever Index Slide Stop Screw Washer..... | 03 |
| 200382c | 11305 | Ruffling Blade Regulating Lever Set Screw | 02 |
| 203345 | 11307 | Ruffling Blade Regulating Lever Shaft... | 25 |
| 201600B | 11307 | Ruffling Blade Regulating Lever Wing Nut | 20 |
| 203344 | 11307 | Ruffling Blade Regulating Lever Washer | 03 |
| 226717 | 11539 | Ruffling Separating Blade..... | 75 |
| 200157b | 11204 | Ruffling Separating Blade Screw..... | 05 |
| 226410 | 11211 | Switching Lever with 200043c, 200162, 200284 and 200909e..... | 1 60 |
| 226411 | 11211 | Switching Lever 226410 with 203935, 226348 and 226413..... | 3 00 |
| 226431 | — | Switching Lever 226411 with 226354..... | 4 00 |
| 226347 | 11203 | Switching Lever Bell Crank..... | 56 |
| 226348 | 11206 | Switching Lever Bell Crank 226347 with 200659c and 201528c..... | 66 |
| 200909e | 11203 | Switching Lever Bell Crank Hinge Screw | 08 |
| 202668 | 11306 | Switching Lever Bell Crank Slide Block | 15 |
| 200659c | 11203 | Switching Lever Bell Crank Slide Block Screw Stud..... | 05 |
| 201528c | 11203 | Switching Lever Bell Crank Slide Block Screw Stud Nut..... | 04 |
| 202104 | 11204 | Switching Lever Bell Crank Slide Block Screw Stud Washer..... | 01 |
| 226413 | 11215 | Switching Lever Latch..... | 50 |
| 200284B | 11204 | Switching Lever Latch Hinge Screw.... | 05 |
| 203935 | 11215 | Switching Lever Latch Spring..... | 02 |
| 202027 | 11215 | Switching Lever Latch Spring Pin..... | 01 |

| No. | Plate | Name | Each |
|---------|-------|---|------|
| 200162 | 11203 | Switching Lever Latch Stop Screw..... | 04 |
| 200043c | 10436 | Switching Lever Pinch Screw..... | 04 |
| 226353 | 11211 | Switching Lever Shaft..... | 35 |
| 226354 | 11211 | Switching Lever Shaft 226353 with 226355 and 226356..... | 1 00 |
| 202305c | 10436 | Switching Lever Shaft Center..... | 06 |
| 200043c | 10436 | Switching Lever Shaft Center Set Screw | 04 |
| 226355 | 11211 | Switching Lever Shaft Spring..... | 30 |
| 226356 | 11204 | Switching Lever Shaft Spring Collar with 200363c | 25 |
| 200363c | 11204 | Switching Lever Shaft Spring Collar Set Screw | 03 |
| 211039 | 11358 | Throat Plate, 50 needle hole, for needle sizes 3 to 5, made in 1¼ in. gauge, for 203462 and 211041..... | 3 00 |
| 211040 | 11358 | Throat Plate, 46 needle hole, for needle sizes 3 to 5, made in 1¼ in. gauge, for 203462 and 211041..... | 3 00 |
| 226719 | — | Ruffling Combination No. 79 complete... | 9 00 |

No. 226725 COMBINATION

(FORMERLY No. 80)

For Corset Covers. Gathers the Corset at will of Operator and
Folds a Strip on the Bottom.

When Ordering, State Gauge Required.

| No. | Plate | Name | Each |
|---------|-------|--|------|
| 211010 | 11355 | Feed Dog (formerly "99") for 211011.... | 60 |
| 226720 | 11540 | Folder (plate) with two 200183..... | 3 00 |
| 226724 | 11532 | Presser Foot..... | 1 00 |
| 226721 | 11540 | Ruffling Separating Blade..... | 35 |
| 200174D | 11204 | Ruffling Separating Blade Screw..... | 02 |
| 226722 | 11540 | Ruffling Separating Blade Bracket with two 200174D..... | 50 |
| 200183 | 11221 | Ruffling Separating Blade Bracket Screw | 02 |
| 226723 | 11540 | Folder 226720 with 226721 and 226722.... | 3 75 |
| 203405 | 11303 | Ruffling Blade..... | 50 |
| 202610 | 11305 | Ruffling Blade Clamp..... | 02 |
| 200174D | 11204 | Ruffling Blade Clamp Screw..... | 02 |
| 202597 | 11306 | Ruffling Blade Lever with 202610 and two 200174D..... | 1 25 |
| 202837 | 11218 | Ruffling Blade Lever Bracket with 202599 and two 202602..... | 1 75 |
| 202602 | 11215 | Ruffling Blade Lever Bracket Pin..... | 05 |
| *202973 | — | Ruffling Blade Lever Bracket Position Collar..... | — |
| *202974 | — | Ruffling Blade Lever Bracket Position Collar Position Pin..... | — |
| 226407 | 11215 | Ruffling Blade Lever Bracket Shaft with 200101D, 202973 and 202974..... | 1 25 |
| 226429 | 11211 | Ruffling Blade Lever Bracket Shaft 226407 with 200289B, 201537, 201566B, 202597, 202598, 202613, 202837 and two 202603..... | 4 75 |
| 202613 | 11213 | Ruffling Blade Lever Bracket Spring.... | 05 |
| 200101B | 11305 | Ruffling Blade Lever Bracket Spring Screw..... | 04 |
| 200289B | 11202 | Ruffling Blade Lever Hinge Screw..... | 05 |
| 201537 | 11202 | Ruffling Blade Lever Hinge Screw Nut.. | 02 |
| 202598 | 11305 | Ruffling Blade Lever Spring..... | 05 |
| *200771 | — | Ruffling Blade Lever Spring Stud..... | — |
| 202599B | 11305 | Ruffling Blade Lever Spring Stud Bracket with 200771..... | 25 |
| 201566B | 11305 | Ruffling Blade Lever Spring Thumb Nut | 05 |
| 202603 | 11305 | Ruffling Blade Lever Spring Thumb Nut Washer..... | 01 |

No. 226725 Combination

141

| No. | Plate | Name | Each |
|---------|-------|---|-------|
| 202603 | 11305 | Ruffling Blade Lever Spring Washer.... | 01 |
| 226410 | 11211 | Switching Lever with 200043c, 200162, 200284 and 200909E..... | 1 60 |
| 226411 | 11211 | Switching Lever 226410 with 203935, 226348 and 226413..... | 3 00 |
| 226431 | — | Switching Lever 226411 with 226354.... | 4 00 |
| 226347 | 11203 | Switching Lever Bell Crank..... | 50 |
| 226348 | 11206 | Switching Lever Bell Crank 226347 with 200659c and 201528c..... | 60 |
| 200909E | 11203 | Switching Lever Bell Crank Hinge Screw | 08 |
| 202668 | 11306 | Switching Lever Bell Crank Slide Block | 15 |
| 200659c | 11203 | Switching Lever Bell Crank Slide Block Screw Stud..... | 05 |
| 201528c | 11203 | Switching Lever Bell Crank Slide Block Screw Stud Nut..... | 04 |
| 202104 | 11204 | Switching Lever Bell Crank Slide Block Screw Stud Washer..... | 01 |
| 226413 | 11215 | Switching Lever Latch..... | 50 |
| 200284B | 11204 | Switching Lever Latch Hinge Screw.... | 05 |
| 203935 | 11215 | Switching Lever Latch Spring..... | 02 |
| 202027 | 11215 | Switching Lever Latch Spring Pin..... | 01 |
| 200162 | 11203 | Switching Lever Latch Stop Screw..... | 04 |
| 200043c | 10436 | Switching Lever Latch Screw..... | 04 |
| 226353 | 11211 | Switching Lever Shaft..... | 35 |
| 226354 | 11211 | Switching Lever Shaft 226353 with 226355 and 226356..... | 1 00 |
| 202305c | 10436 | Switching Lever Shaft Center..... | 06 |
| 200043c | 10436 | Switching Lever Shaft Center Set Screw | 04 |
| 226355 | 11211 | Switching Lever Shaft Spring..... | 30 |
| 226356 | 11204 | Switching Lever Shaft Spring Collar with 200363c..... | 25 |
| 200363c | 11204 | Switching Lever Shaft Spring Collar Set Screw..... | 03 |
| 11011 | 11358 | Throat Plate (formerly "99-F") 50 needle hole, for needle sizes 3 to 5, made in gauges from ¼ in. to ⅜ in., for 203462 and 211010..... | 1 25 |
| 226725 | — | Ruffling Combination No. 80 complete... | 10 50 |

From the library of: Diamond Needle Corp

No. 226734 COMBINATION

(FORMERLY No. 81.)

For Corset Covers. Gathers the Corset Cover at will of Operator,
Folds a Strip on Top and Guides a Puckering Tape Between
Them. Puckering Tape May Be Switched Into the Seam
For a Short Distance, to Prevent Pulling Out.

When Ordering, State Gauge Required.

| | | | |
|---------|-------|--|-------|
| 211044 | 11356 | Feed Dog (formerly "121") for 211031 and 211032..... | 75 |
| 226733 | 11536 | Presser Foot 226729 with 226730 to 226732 | 10 00 |
| 226729 | 11536 | Presser Foot Strip Folder with 200924.. | 4 00 |
| 226730 | 11541 | Puckering Tape Guide (on shank) with two 200174D..... | 2 50 |
| 226732 | 11541 | Puckering Tape Guide Stop..... | 50 |
| 200174D | 11204 | Puckering Tape Guide Stop Screw..... | 02 |
| 226731 | 11541 | Puckering Tape Guide Switching Lever | 50 |
| 200924 | 11541 | Puckering Tape Guide Switching Lever Hinge Screw..... | 02 |
| 226634 | 11524 | Ruffling Blade..... | 50 |
| 226726 | 11540 | Ruffling Blade Lever Bracket with 202599B | 50 |
| 226727 | 11541 | Ruffling Blade Lever Bracket 226726 with 200289, 201537, 201566B, 202597, 202598 and two 202603..... | 1 75 |
| 226728 | 11541 | Ruffling Separating Blade..... | 50 |
| 200157B | 11204 | Ruffling Separating Blade Screw..... | 02 |
| 226410 | 11211 | Switching Lever with 200043c, 200162, 200284 and 200909E..... | 1 60 |
| 226411 | 11211 | Switching Lever 226410 with 203935, 226348 and 226413..... | 3 00 |
| 226431 | — | Switching Lever 226411 with 226354..... | 4 00 |
| 226347 | 11203 | Switching Lever Bell Crank..... | 50 |
| 226348 | 11206 | Switching Lever Bell Crank 226347 with 200659c and 201528D..... | 60 |
| 200909E | 11203 | Switching Lever Bell Crank Hinge Screw | 02 |
| 202668 | 11306 | Switching Lever Bell Crank Slide Block | 12 |
| 200659c | 11203 | Switching Lever Bell Crank Slide Block Screw Stud..... | 00 |
| 201528C | 11203 | Switching Lever Bell Crank Slide Block Screw Stud Nut..... | 00 |
| 202104 | 11204 | Switching Lever Bell Crank Slide Block Screw Stud Washer..... | 00 |
| 226413 | 11215 | Switching Lever Latch..... | 50 |
| 200284B | 11204 | Switching Lever Latch Hinge Screw.... | 00 |
| 203935 | 11215 | Switching Lever Latch Spring..... | 00 |

| No. | Plate | Name | Each |
|---------|-------|--|-------|
| 202027 | 11215 | Switching Lever Latch Spring Pin..... | 01 |
| 200162D | 11203 | Switching Lever Latch Stop Screw..... | 04 |
| 200043c | 10436 | Switching Lever Pinch Screw..... | 04 |
| 226353 | 11211 | Switching Lever Shaft..... | 35 |
| 226354 | 11211 | Switching Lever Shaft 226353 with 226355 and 226356..... | 1 00 |
| 202305c | 10436 | Switching Lever Shaft Center..... | 06 |
| 200043c | 10436 | Switching Lever Shaft Center Set Screw | 04 |
| 226355 | 11211 | Switching Lever Shaft Spring..... | 30 |
| 226356 | 11204 | Switching Lever Shaft Spring Collar with 200363c | 25 |
| 200363c | 11204 | Switching Lever Shaft Spring Collar Set Screw | 03 |
| 211031 | 11356 | Throat Plate (formerly "57-F") 50 needle hole, for needle sizes 3 to 5, made in gauges from $\frac{1}{4}$ in. to $\frac{1}{2}$ in. in steps of $\frac{1}{8}$ in., for 203462 and 211044..... | 1 25 |
| 211032 | 11356 | Throat Plate (formerly "57-F") 46 needle hole, for needle sizes 5 to 7, made in gauges from $\frac{1}{4}$ in. to $\frac{1}{2}$ in. in steps of $\frac{1}{8}$ in., for 203462 and 211044..... | 1 25 |
| 226734 | — | Ruffling Combination No. 81 complete... | 16 50 |

No. 226737 COMBINATION

(FORMERLY No. 82.)

For Skirt Work. Guides the Ruffle, Folds and Lays a Strip on Top and Stitches Both to the Face of the Material.

When Ordering, State Gauge Required.

| No. | Plate | Name | Each |
|---------|-------|--|------|
| 226393 | 11214 | Attachment Arm Switch (to the right) with two 200187a..... | 1 25 |
| 226394 | 11214 | Attachment Arm Switch with 226398, 226397 and 226399..... | 2 15 |
| 226395 | 11214 | Attachment Arm Switch Bracket with 200272b, 22032 and two 200911..... | 1 25 |
| 226396 | 11211 | Attachment Arm Switch Bracket 226395 with 226394..... | 3 35 |
| 200911 | 11213 | Attachment Arm Switch Bracket Screw | 05 |
| 200272b | 11213 | Attachment Arm Switch Hinge Screw... | 08 |
| 228032 | 11213 | Attachment Arm Switch Hinge Screw Washer | 01 |
| 226397 | 11213 | Attachment Arm Switch Latch with 2000272b and 226398..... | 85 |
| 200272b | 11213 | Attachment Arm Switch Latch Hinge Screw | 08 |
| 200272b | 11213 | Attachment Arm Switch Hinge Screw... | 08 |
| 226398 | 11213 | Attachment Arm Switch Latch Hinge Screw Washer..... | 01 |
| 226399 | 11213 | Attachment Arm Switch Latch Spring... | 05 |
| 211010 | 11355 | Feed Dog (formerly "99") for 211011.... | 60 |
| 226735 | 11542 | Guide and Separating Blade (on shank) | 1 00 |
| 200173 | 11215 | Guide and Separating Blade Screw..... | 04 |
| 226423 | 11215 | Guide and Separating Blade Bracket (intermediate) with two 200173..... | 60 |
| 226736 | 11522 | Guide and Separating Blade Bracket 226423 with 226735..... | 1 60 |
| 226609 | 11520 | Presser Foot (strip folder)..... | 2 50 |
| 226506 | 11502 | Ruffling Blade..... | 50 |
| 202610 | 11305 | Ruffling Blade Clamp..... | 02 |
| 200174b | 11204 | Ruffling Blade Clamp Screw..... | 02 |
| 202597 | 11306 | Ruffling Blade Lever with 202610 and two 200174b | 1 25 |
| 202837 | 11218 | Ruffling Blade Lever Bracket with 202599b and two 202602..... | 1 75 |
| 202602 | 11215 | Ruffling Blade Lever Bracket Pin..... | 05 |
| *202973 | — | Ruffling Blade Lever Bracket Position Collar | — |
| *202974 | — | Ruffling Blade Lever Bracket Position Collar Position Pin..... | — |

| No. | Plate | Name | Each |
|---------|-------|--|------|
| 226407 | 11215 | Ruffling Blade Lever Bracket Shaft with 200101b, 202973 and 202974..... | 1 25 |
| 226429 | 11211 | Ruffling Blade Lever Bracket Shaft 226407 with 200289b, 201537, 201566b, 202597, 202598, 202613, 202837 and two 202603 | 4 75 |
| 202613 | 11213 | Ruffling Blade Lever Bracket Spring.... | 03 |
| 200101b | 11305 | Ruffling Blade Lever Bracket Spring Screw | 04 |
| 200289b | 11202 | Ruffling Blade Lever Hinge Screw..... | 05 |
| 201537 | 11202 | Ruffling Blade Lever Hinge Screw Nut.. | 03 |
| 202598 | 11305 | Ruffling Blade Lever Spring..... | 05 |
| *200771 | — | Ruffling Blade Lever Spring Stud..... | — |
| 202599b | 11305 | Ruffling Blade Lever Spring Stud Bracket with 200771..... | 25 |
| 201566b | 11305 | Ruffling Blade Lever Spring Thumb Nut | 05 |
| 202603 | 11305 | Ruffling Blade Lever Spring Thumb Nut Washer | 01 |
| 202603 | 11305 | Ruffling Blade Lever Spring Washer.... | 01 |
| 226410 | 11211 | Switching Lever with 200043c, 200162, 200284 and 200909e..... | 1 60 |
| 226411 | 11211 | Switching Lever 226410 with 203935, 226348 and 226413..... | 3 00 |
| 226431 | — | Switching Lever 226411 with 226351.... | 4 00 |
| 226347 | 11203 | Switching Lever Bell Crank..... | 50 |
| 226348 | 11206 | Switching Lever Bell Crank 226347 with 200659c and 201528c..... | 60 |
| 200909e | 11203 | Switching Lever Bell Crank Hinge Screw | 08 |
| 202668 | 11306 | Switching Lever Bell Crank Slide Block | 15 |
| 200659c | 11203 | Switching Lever Bell Crank Slide Block Screw Stud..... | 05 |
| 201528c | 11203 | Switching Lever Bell Crank Slide Block Screw Stud Nut..... | 04 |
| 202104 | 11204 | Switching Lever Bell Crank Slide Block Screw Stud Washer..... | 01 |
| 226413 | 11215 | Switching Lever Latch..... | 50 |
| 200284b | 11204 | Switching Lever Latch Hinge Screw.... | 05 |
| 203935 | 11215 | Switching Lever Latch Spring..... | 02 |
| 202027 | 11215 | Switching Lever Latch Spring Pin..... | 01 |
| 200162 | 11203 | Switching Lever Latch Stop Screw..... | 04 |
| 200043c | 10436 | Switching Lever Pinch Screw..... | 04 |

From the library of: Diamond Needle Corp.

| No. | Plate | Name | Each |
|---------|-------|---|-------|
| 226353 | 11211 | Switching Lever Shaft..... | 35 |
| 226354 | 11211 | Switching Lever Shaft 226353 with 226355 and 226356..... | 1 00 |
| 202305c | 10436 | Switching Lever Shaft Center..... | 06 |
| 200043c | 10436 | Switching Lever Shaft Center Set Screw | 04 |
| 226355 | 11211 | Switching Lever Shaft Spring..... | 20 |
| 226356 | 11204 | Switching Lever Shaft Spring Collar with 200363c..... | 25 |
| 200363c | 11204 | Switching Lever Shaft Spring Collar Set Screw..... | 03 |
| 211011 | 11358 | Throat Plate (formerly "99-F") 50 needle hole, for needle sizes 3 to 5, made in ganges $\frac{1}{8}$, $\frac{3}{16}$, $\frac{1}{4}$, $\frac{5}{16}$ and $\frac{3}{8}$ in., for 203462 and 211010..... | 1 25 |
| 226737 | — | Ruffling Combination No. 82 complete... | 19 00 |

No. 226746 COMBINATION

(FORMERLY No. 83.)

For Underwear and Childrens Waists. Turns the Edge of the Garment Up and Ruffles It. Guides a Lace Edging and a Folded Strip. The Guides Are So Arranged That the End of the Lace and the Folded Strip May Be Turned Under When Starting and Finishing the Seam.

When Ordering, State Gauge Required.

| No. | Plate | Name | Each |
|---------|-------|--|------|
| 211022 | 11354 | Feed Dog (formerly "22") for 211021.... | 75 |
| 226742 | 11511 | Folder (on shank)..... | 2 00 |
| 226740 | 11512 | Guide..... | 50 |
| 202090 | 10443 | Presser Foot Hinge Pin..... | 01 |
| 226744 | --- | Presser Foot Plate..... | 2 00 |
| 202928 | --- | Presser Foot Shank..... | 75 |
| 226745 | 11544 | Presser Foot (strip guide) complete, Nos. 202090, 202928 and 226744..... | 2 75 |
| 226743 | 11539 | Ruffling Blade..... | 50 |
| 226687 | 11532 | Ruffling Blade Lever Bracket..... | 50 |
| 202571 | 11306 | Ruffling Blade Regulating Lever Shaft Collar with 200380c..... | 15 |
| 200380c | 11202 | Ruffling Blade Regulating Lever Shaft Collar Set Screw..... | 02 |
| 226688 | 11531 | Ruffling Blade Lever Bracket 226687 with 201556b, 202598, 226683 and two 202603 | 1 75 |
| 226339 | 11202 | Ruffling Blade Regulating Lever with two 200382c..... | 1 75 |
| 226738 | 11512 | Swing Bracket with 200170 and 200369b... | 40 |
| 200369b | 11220 | Swing Bracket Adjusting Screw..... | 06 |
| 225735 | 11220 | Swing Bracket Base..... | 40 |
| 200157b | 11204 | Swing Bracket Base Screw..... | 05 |
| 200157b | 11204 | Swing Bracket Hinge Screw..... | 05 |
| 225925 | 11220 | Swing Bracket Hinge Screw Washer.... | 05 |
| 226739 | 11543 | Swing Bracket 226738 with 200157b, 225735, 225925 and 226740..... | 1 50 |
| 226410 | 11211 | Switching Lever with 200043c, 200162, 200284 and 200909e..... | 1 60 |
| 226411 | 11211 | Switching Lever 226410 with 203935, 226348 and 226413..... | 3 00 |
| 226431 | --- | Switching Lever 226411 with 226354.... | 4 00 |
| 226347 | 11203 | Switching Lever Bell Crank..... | 50 |
| 226348 | 11206 | Switching Lever Bell Crank 226347 with 200659c and 201528c..... | 60 |
| 200909e | 11203 | Switching Lever Bell Crank Hinge Screw | 08 |

From the library of: Diamond Needle Corp

| No. | Plate | Name | Each |
|---------|-------|--|-------|
| 202668 | 11306 | Switching Lever Bell Crank Slide Block | 15 |
| 200659c | 11203 | Switching Lever Bell Crank Slide Block Screw Stud..... | 05 |
| 201528c | 11203 | Switching Lever Bell Crank Slide Block Screw Stud Nut..... | 04 |
| 202104 | 11204 | Switching Lever Bell Crank Slide Block Screw Stud Washer..... | 01 |
| 226413 | 11215 | Switching Lever Latch..... | 50 |
| 200284B | 11204 | Switching Lever Latch Hinge Screw.... | 05 |
| 203935 | 11215 | Switching Lever Latch Spring..... | 02 |
| 202027 | 11215 | Switching Lever Latch Spring Pin..... | 01 |
| 200162 | 11203 | Switching Lever Latch Stop Screw..... | 04 |
| 200043c | 10436 | Switching Lever Pinch Screw..... | 04 |
| 226353 | 11211 | Switching Lever Shaft..... | 35 |
| 226354 | 11211 | Switching Lever Shaft 226353 with 226355 and 226356..... | 1 00 |
| 202305c | 10436 | Switching Lever Shaft Center..... | 06 |
| 200043c | 10436 | Switching Lever Shaft Center Set Screw | 04 |
| 226355 | 11211 | Switching Lever Shaft Spring..... | 30 |
| 226356 | 11204 | Switching Lever Shaft Spring Collar with 200363c..... | 25 |
| 200363c | 11204 | Switching Lever Shaft Spring Collar Set Screw..... | 03 |
| 226741 | 11544 | Tape Guide (upper)..... | 1 00 |
| 200157B | 11204 | Tape Guide Screw..... | 05 |
| 211021 | 11354 | Throat Plate (formerly "22-F") 50 needle hole, for needle sizes 3 to 5, made in gauges from $\frac{1}{4}$ in. to $\frac{1}{8}$ in. in steps of $\frac{1}{32}$ in., for 203462 and 211022..... | 1 25 |
| 226746 | — | Ruffling Combination No. 83 complete... | 10 00 |

No. 226751 COMBINATION

(FORMERLY No. 84)

For Underwear. Forms a Narrow Band From Two Strips, Folding the Four Edges of Strips, Making and Inserting the Ruffle.

When Ordering, State Gauge Required.

| No. | Plate | Name | Each |
|----------|-------|--|------|
| 211010 | 11355 | Feed Dog (formerly "99") for 211011.... | 60 |
| 226747 | 11542 | Folder (plate) with two 200173..... | 3 00 |
| 200157B | 11204 | Folder Screw..... | 05 |
| 226748 | 11545 | Guide (on shank) with two 200174D.... | 1 75 |
| 226542 | 11507 | Presser Foot (strip folder)..... | 2 50 |
| 226749 | 11545 | Ruffling Separating Blade..... | 50 |
| 200174D | 11204 | Ruffling Separating Blade Screw..... | 02 |
| 226750 | 11545 | Folder 226747 with 226748 and 226749.... | 4 50 |
| 226506 | 11502 | Ruffling Blade..... | 50 |
| 202610 | 11305 | Ruffling Blade Clamp..... | 02 |
| 200174D | 11204 | Ruffling Blade Clamp Screw..... | 02 |
| 202597 | 11306 | Ruffling Blade Lever with 202610 and two 200174D..... | 1 25 |
| 202837 | 11218 | Ruffling Blade Lever Bracket with 202597B and two 202602..... | 1 75 |
| 202602 | 11215 | Ruffling Blade Lever Bracket Pin..... | 05 |
| *202973 | — | Ruffling Blade Lever Bracket Position Collar..... | 05 |
| *202974 | — | Ruffling Blade Lever Bracket Position Collar Position Pin..... | 02 |
| 226407 | 11215 | Ruffling Blade Lever Bracket Shaft with 200101D, 202973 and 202974..... | 1 25 |
| 226429 | 11211 | Ruffling Blade Lever Bracket Shaft 226407 with 200289B, 201537, 201566B, 202597, 202598, 202613, 202837 and two 202603..... | 4 75 |
| 202613 | 11213 | Ruffling Blade Bracket Spring..... | 03 |
| 200101D | 11305 | Ruffling Blade Lever Bracket Spring Screw..... | 04 |
| 200289B | 11202 | Ruffling Blade Lever Hinge Screw..... | 05 |
| 201537 | 11202 | Ruffling Blade Lever Hinge Screw Nut.. | 03 |
| 202598 | 11305 | Ruffling Blade Lever Spring..... | 05 |
| *200771 | — | Ruffling Blade Lever Spring Stud..... | — |
| 202599B | 11305 | Ruffling Blade Lever Spring Stud Bracket with 200771..... | 25 |
| *201566B | 11305 | Ruffling Blade Lever Spring Thumb Nut | 05 |
| 202603 | 11305 | Ruffling Blade Lever Spring Thumb Nut Washer..... | 01 |

| No. | Plate | Name | Each |
|---------|-------|---|-------|
| 202603 | 11305 | Ruffling Blade Lever Spring Washer.... | 01 |
| 226410 | 11211 | Switching Lever with 200043c, 200162, 200284 and 200909e..... | 1 60 |
| 226411 | 11211 | Switching Lever 226410 with 203935, 226348 and 226413..... | 3 00 |
| 226431 | — | Switching Lever 226411 with 226351..... | 4 00 |
| 226347 | 11203 | Switching Lever Bell Crank..... | 50 |
| 226348 | 11206 | Switching Lever Bell Crank 226347 with 200659c and 201528c..... | 60 |
| 200909e | 11203 | Switching Lever Bell Crank Hinge Screw | 08 |
| 202668 | 11306 | Switching Lever Bell Crank Slide Block | 15 |
| 200659c | 11203 | Switching Lever Bell Crank Slide Block Screw Stud..... | 05 |
| 201528c | 11203 | Switching Lever Bell Crank Slide Block Screw Stud Nut..... | 04 |
| 202104 | 11204 | Switching Lever Bell Crank Slide Block Screw Stud Washer..... | 01 |
| 226413 | 11215 | Switching Lever Latch..... | 50 |
| 200284b | 11204 | Switching Lever Latch Hinge Screw.... | 05 |
| 203935 | 11215 | Switching Lever Latch Spring..... | 02 |
| 202027 | 11215 | Switching Lever Latch Spring Pin..... | 01 |
| 200162 | 11203 | Switching Lever Latch Stop Screw..... | 04 |
| 200043c | 10436 | Switching Lever Pinch Screw..... | 04 |
| 226353 | 11211 | Switching Lever Shaft..... | 35 |
| 226354 | 11211 | Switching Lever Shaft 226353 with 226355 and 226356..... | 1 00 |
| 202305c | 10436 | Switching Lever Shaft Center..... | 06 |
| 200043c | 10436 | Switching Lever Shaft Center Set Screw | 04 |
| 226355 | 11211 | Switching Lever Shaft Spring..... | 30 |
| 226356 | 11204 | Switching Lever Shaft Spring Collar with 200363c..... | 25 |
| 200363c | 11204 | Switching Lever Shaft Spring Collar Set Screw..... | 03 |
| 211011 | 11358 | Throat Plate (formerly "99-F") 50 needle hole, for needle sizes 3 to 5, made in gauges 1, 2, 3, 4, 5 and 6 in., for 203462 and 211010..... | 1 25 |
| 226751 | — | Ruffling Combination No. 84 complete... | 14 00 |

No. 226493 COMBINATION

(FORMERLY No. 87)

For Aprons and Ladies' Underwear. Folds the Band and Ruffles
the Apron or Garment Between the Folded Edges.

| No. | Plate | Name | Each |
|---------|-------|---|-------|
| 211007 | 11350 | Feed Dog (formerly "262-F") for 211003 | 85 |
| 226453 | 11222 | Folder and Separating Blade (on shank) | 12 00 |
| 226487 | 11212 | Folder Base Plate with two 200187b.... | 60 |
| 200187b | 11213 | Folder Screw..... | 04 |
| 226455 | 11221 | Folder Screw Clamp Washer..... | 05 |
| 226456 | 11223 | Presser Foot..... | 1 00 |
| 226457 | 11223 | Ruffling Blade..... | 35 |
| 226330 | 11202 | Ruffling Blade Clamp..... | 05 |
| 200179b | 11208 | Ruffling Blade Clamp Screw..... | 02 |
| 226341 | 11223 | Ruffling Blade Driving Lever Shaft.... | 25 |
| 202574 | 11306 | Ruffling Blade Driving Lever Shaft Collar with 200380c..... | 15 |
| 200380c | 11202 | Ruffling Blade Driving Lever Shaft Collar Set Screw..... | 02 |
| 226458 | 11223 | Ruffling Blade Lever with 226330 and two 200179b..... | 1 25 |
| *203340 | 11202 | Ruffling Blade Lever Bracket (adjust- able)..... | 25 |
| 203341 | 11306 | Ruffling Blade Lever Bracket 203340 with 202599b..... | 50 |
| 203342 | 11306 | Ruffling Blade Lever Bracket Crank with two each 200098b, 200382c and 202600 | 75 |
| 200382c | 11305 | Ruffling Blade Lever Bracket Crank Set Screw..... | 02 |
| 200098b | 10438 | Ruffling Blade Lever Bracket Screw.... | 03 |
| 202600 | 11203 | Ruffling Blade Lever Bracket Screw Washer..... | 01 |
| 200289 | 11202 | Ruffling Blade Lever Hinge Screw..... | 05 |
| 201537 | 11202 | Ruffling Blade Lever Hinge Screw Nut.. | 03 |
| 202598 | 11305 | Ruffling Blade Lever Spring..... | 05 |
| *200771 | — | Ruffling Blade Lever Spring Stud..... | — |
| 202599b | 11305 | Ruffling Blade Lever Spring Stud Bracket with 200771..... | 25 |
| 201566b | 11305 | Ruffling Blade Lever Spring Thumb Nut | 05 |
| 202603 | 11305 | Ruffling Blade Lever Spring Thumb Nut Washer..... | 01 |
| 202603 | 11305 | Ruffling Blade Lever Spring Washer.... | 01 |
| 202605b | 11306 | Ruffling Blade Lifting Lever..... | 25 |
| 200168c | 11306 | Ruffling Blade Lifting Lever Set Screw.. | 02 |

| No. | Plate | Name | Each |
|---------|-------|---|-------|
| 202606 | 11303 | Ruffling Blade Lifting Lever Stud (adjustable) with 200072c and 200168c | 45 |
| 226340 | 11202 | Ruffling Blade Lifting Lever Stud 202606 with 202605b..... | 70 |
| 200072c | 11010 | Ruffling Blade Lifting Lever Stud Pinch Screw | 03 |
| 226410 | 11211 | Switching Lever with 200043c, 200162, 200284 and 200909e..... | 1 60 |
| 226411 | 11211 | Switching Lever 226410 with 203935, 226348 and 226413..... | 3 00 |
| 226347 | 11203 | Switching Lever Bell Crank..... | 50 |
| 226348 | 11206 | Switching Lever Bell Crank 226347 with 200659 and 201528c..... | 60 |
| 200909e | 11203 | Switching Lever Bell Crank Hinge Screw | 08 |
| 202668 | 11306 | Switching Lever Bell Crank Slide Block | 15 |
| 200659c | 11203 | Switching Lever Bell Crank Slide Block Screw Stud..... | 05 |
| 201528c | 11203 | Switching Lever Bell Crank Slide Block Screw Stud Nut..... | 01 |
| 202104 | 11204 | Switching Lever Bell Crank Slide Block Screw Stud Washer..... | 01 |
| 226413 | 11215 | Switching Lever Latch..... | 50 |
| 200284B | 11204 | Switching Lever Latch Hinge Screw.... | 05 |
| 203935 | 11215 | Switching Lever Latch Spring..... | 02 |
| 202027 | 11215 | Switching Lever Latch Spring Pin..... | 01 |
| 200162 | 11203 | Switching Lever Latch Stop Screw..... | 04 |
| 200043c | 10436 | Switching Lever Pinch Screw..... | 04 |
| 226353 | 11211 | Switching Lever Shaft..... | 35 |
| 226354 | 11211 | Switching Lever Shaft 226353 with 226355 and 226356..... | 1 00 |
| 202305c | 10436 | Switching Lever Shaft Center..... | 06 |
| 200043c | 10436 | Switching Lever Shaft Center Set Screw | 04 |
| 226355 | 11211 | Switching Lever Shaft Spring..... | 30 |
| 226356 | 11204 | Switching Lever Shaft Spring Collar with 200363c | 25 |
| 200363c | 11204 | Switching Lever Shaft Spring Collar Set Screw | 03 |
| 211003 | 11350 | Throat Plate (formerly "21-12-F") 50 needle hole, for needle sizes 3 to 5, for 203253 and 211007..... | 1 00 |
| 226493 | --- | Ruffling Combination No. 87 complete... | 18 50 |

No. 226793 COMBINATION

(FORMERLY No. 94)

For Army Pants Made of Kahki Goods. For Gathering the Top of the Pants to a Band.

| No. | Plate | Name | Each |
|---------|-------|---|------|
| 226491 | 11204 | Bed Slide (back) with 200798..... | 05 |
| 226492 | 11212 | Bed Slide (back) 226491 with 201557 225744 | 65 |
| 211006 | 11350 | Feed Dog (formerly "26-F") for 211005.. | 75 |
| 225744 | 11225 | Guide | 15 |
| 200798 | --- | Guide Screw Stud..... | 04 |
| 201557 | 11225 | Guide Screw Stud Thumb Nut..... | 15 |
| 226479 | 11226 | Presser Foot..... | 1 50 |
| 226480 | 11226 | Ruffling Blade..... | 35 |
| 202610 | 11305 | Ruffling Blade Clamp..... | 02 |
| 200174b | 11204 | Ruffling Blade Clamp Screw..... | 02 |
| 226481 | 11226 | Ruffling Blade Lever with 202610 and two 200174b | 2 00 |
| 203340 | 11202 | Ruffling Blade Lever Bracket (adjustable) | 25 |
| 226482 | 11216 | Ruffling Blade Lever Bracket 203340 with 200113c, 200289b, 201537, 206042, 226334 and 226481..... | 2 50 |
| 203212 | 11306 | Ruffling Blade Lever Bracket Crank with two each 200098b, 200382c and 202600.. | 75 |
| 200382c | 11305 | Ruffling Blade Lever Bracket Crank Set Screw | 02 |
| 200098A | 10438 | Ruffling Blade Lever Bracket Screw.... | 03 |
| 202600 | 11202 | Ruffling Blade Lever Bracket Screw Washer | 01 |
| 200289B | 11202 | Ruffling Blade Lever Hinge Screw..... | 05 |
| 201537 | 11202 | Ruffling Blade Lever Hinge Screw Nut.. | 03 |
| 206042 | 11202 | Ruffling Blade Lever Spring..... | 03 |
| 26334 | 11202 | Ruffling Blade Lever Spring Bracket.... | 25 |
| 00113c | 10436 | Ruffling Blade Lever Spring Bracket Screw | 03 |
| 26335 | 11201 | Ruffling Blade Lifting Lever..... | 75 |
| 26359 | 11201 | Ruffling Blade Lifting Lever 226335 with 226336 and two 202907B..... | 1 00 |
| 26336 | 11204 | Ruffling Blade Lifting Lever Extension.. | 25 |
| 00907B | 11201 | Ruffling Blade Lifting Lever Extension Screw | 02 |
| 20284D | 11201 | Ruffling Blade Lifting Lever Hinge Screw | 05 |

From the library of: Diamond Needle Corp

| No. | Plate | Name | Each |
|---------|-------|--|------|
| 202104 | 11204 | Ruffling Blade Lifting Lever Hinge Screw Washer | 01 |
| 226337 | 11204 | Ruffling Blade Lifting Lever Stop | 15 |
| 200174D | 11204 | Ruffling Blade Lifting Lever Position Stop Screw | 02 |
| 226338 | 11204 | Ruffling Blade Lifting Pin | 02 |
| 226339 | 11202 | Ruffling Blade Regulating Lever with two 200382c | 1 75 |
| 200382c | 11305 | Ruffling Blade Regulating Lever Set Screw | 02 |
| 203345 | 11307 | Ruffling Blade Regulating Lever Shaft | 25 |
| 226483 | 11211 | Ruffling Blade Regulating Lever Shaft 203345 with 203342 | 1 00 |
| 226484 | ---- | Ruffling Blade Regulating Lever Shaft 226483 with 226482 | 3 50 |
| 226409 | 11213 | Ruffling Blade Regulating Lever Slide Stop Block | 35 |
| 202608 | 11303 | Ruffling Blade Regulating Lever Index Slide | 25 |
| 201600B | 11307 | Ruffling Blade Regulating Lever Wing Nut | 20 |
| 203344 | 11307 | Ruffling Blade Regulating Lever Washer | 03 |
| 226485 | 11226 | Ruffling Separating Blade | 25 |
| 226486 | 11212 | Ruffling Separating Blade Shank with two 200174 | 75 |
| 200187 | 11213 | Ruffling Separating Blade Shank Screw | 0 |
| 226487 | 11212 | Ruffling Separating Blade Base Plate with two 200187c | 60 |
| 225708 | 11226 | Ruffling Separating Blade Base Plate Spring | 10 |
| 200246 | 11226 | Ruffling Separating Blade Base Plate Hinge Screw | 0 |
| 200174D | 11204 | Ruffling Separating Blade Screw | 6 |
| 226488 | 11212 | Ruffling Separating Blade Base Plate 226487 with 200246, 225708, 226485 and 226486 | 1 6 |
| 226345 | 11211 | Switching Lever with 200043c, 200284D, 200907e, 200909, 226338 and three 200162D | 1 6 |
| 226489 | 11211 | Switching Lever 226345 with 203935, 226348 and 226413 | 3 0 |
| 226490 | ---- | Switching Lever 226489 with 226354 | 4 0 |
| 226347 | 11203 | Switching Lever Bell Crank | 5 |
| 226348 | 11206 | Switching Lever Bell Crank 226347 with 200659c and 201528D | 6 |
| 200909E | 11203 | Switching Lever Bell Crank Hinge Screw | 0 |
| 226349 | 11203 | Switching Lever Bell Crank Slide Block | 2 |
| 200659c | 11203 | Switching Lever Bell Crank Slide Block Screw Stud | 0 |

| No. | Plate | Name | Each |
|---------|-------|--|-------|
| 201528D | 11203 | Switching Lever Bell Crank Slide Block Screw Stud Nut | 04 |
| 202600 | 11202 | Switching Lever Bell Crank Slide Block Screw Stud Washer | 01 |
| 226413 | 11215 | Switching Lever Latch | 50 |
| 200284D | 11204 | Switching Lever Latch Hinge Screw | 05 |
| 203935 | 11215 | Switching Lever Latch Spring | 02 |
| 202027 | 11215 | Switching Lever Latch Spring Pin | 01 |
| 200162D | 11203 | Switching Lever Latch Stop Screw | 04 |
| 200043c | 10436 | Switching Lever Pinch Screw | 04 |
| 226353 | 11211 | Switching Lever Shaft | 35 |
| 226354 | 11211 | Switching Lever Shaft 226353 with 226355 and 226356 | 1 00 |
| 202305c | 10436 | Switching Lever Shaft Center | 06 |
| 200043c | 10436 | Switching Lever Shaft Center Set Screw | 04 |
| 226355 | 11211 | Switching Lever Shaft Spring | 30 |
| 226356 | 11204 | Switching Lever Shaft Spring Collar with 200363c | 25 |
| 200363c | 11204 | Switching Lever Shaft Spring Collar Set Screw | 03 |
| 211005 | 11350 | Throat Plate, 50 needle hole, for needle sizes 3 to 5, for 203253 and 211006 | 1 00 |
| 226793 | ---- | Ruffling Combination No. 94 complete | 16 00 |

No. 226756 COMBINATION

(FORMERLY No. 95)

For Ladies' Underwear. Folds the Edge of the Garment and a Strip and Lays a Ruffle Between Them.

When Ordering, State Gauge Required.

| | | | | |
|---------|-------|--|---|----|
| 226393 | 11214 | Attachment Arm Switch (to the right) with two 200187B..... | 1 | 25 |
| 226394 | 11214 | Attachment Arm Switch with 226393, 226397 and 226399..... | 2 | 15 |
| 226395 | 11214 | Attachment Arm Switch Bracket with 200272B, 228032 and two 200911..... | 1 | 25 |
| 226396 | 11211 | Attachment Arm Switch Bracket 226395 with 226394..... | 3 | 35 |
| 200911 | 11213 | Attachment Arm Switch Bracket Screw..... | | 05 |
| 200272B | 11213 | Attachment Arm Switch Hinge Screw.... | | 08 |
| 228032 | 11213 | Attachment Arm Switch Hinge Screw Washer..... | | 01 |
| 226397 | 11213 | Attachment Arm Switch Latch with 200272B and 226398..... | | 85 |
| 200272B | 11213 | Attachment Arm Switch Latch Hinge Screw..... | | 08 |
| 226398 | 11213 | Attachment Arm Switch Latch Hinge Screw Washer..... | | 01 |
| 226399 | 11213 | Attachment Arm Switch Latch Spring.. | | 05 |
| 211010 | 11355 | Feed Dog (formerly "99") for 211011.... | | 60 |
| 226693 | 11536 | Folder (lower) (plate) with 200305..... | 2 | 00 |
| 200157B | 11204 | Folder (lower) Screw..... | | 05 |
| 226696 | 11536 | Folder 226693 with 226694 and 226695.... | 3 | 00 |
| 226710 | 11538 | Guide (on shank)..... | 1 | 00 |
| 226423 | 11215 | Guide Bracket (intermediate) with two 200173..... | | 60 |
| 226711 | 11522 | Guide Bracket 226423 with 226710..... | 1 | 60 |
| 200187B | 11213 | Guide Bracket Screw..... | | 04 |
| 200173 | 11215 | Guide Screw..... | | 04 |
| 226542 | 11507 | Presser Foot (strip folder)..... | 2 | 50 |
| 202090 | 10443 | Presser Foot Hinge Pin..... | | 01 |
| 226754 | — | Presser Foot Plate..... | 2 | 25 |
| 202928 | — | Presser Foot Shank..... | | 75 |
| 226755 | 11544 | Presser Foot (strip guide) complete, Nos. 202090, 202928 and 226754..... | 3 | 00 |
| 226694 | 11534 | Ruffling Separating Blade (switch)..... | | 25 |
| 200183 | 11221 | Ruffling Separating Blade Screw..... | | 02 |
| 226695 | 11534 | Ruffling Separating Blade Switching Lever with two 200183..... | | 60 |

| No. | Plate | Name | Each |
|---------|-------|--|------|
| 226506 | 11502 | Ruffling Blade..... | 50 |
| 202610 | 11305 | Ruffling Blade Clamp..... | 02 |
| 200174b | 11204 | Ruffling Blade Clamp Screw..... | 02 |
| 202597 | 11306 | Ruffling Blade Lever with 202610 and two 200174b..... | 1 25 |
| 202837 | 11218 | Ruffling Blade Lever Bracket with 202599B and two 202602..... | 1 75 |
| 202602 | 11215 | Ruffling Blade Lever Bracket Pin..... | 05 |
| *202973 | — | Ruffling Blade Lever Bracket Position Collar..... | — |
| *202974 | — | Ruffling Blade Lever Bracket Position Collar Position Pin..... | — |
| 226407 | 11215 | Ruffling Blade Lever Bracket Shaft with 200101b, 202973 and 202974..... | 1 25 |
| 226429 | 11211 | Ruffling Blade Lever Bracket Shaft 226407 with 200289, 201537, 201566B, 202597, 202598, 202613, 202837 and two 202603..... | 4 25 |
| 202613 | 11213 | Ruffling Blade Lever Bracket Spring.... | 03 |
| 200101b | 11305 | Ruffling Blade Lever Bracket Spring Screw..... | 04 |
| 200289B | 11202 | Ruffling Blade Lever Hinge Screw..... | 03 |
| 201537 | 11202 | Ruffling Blade Lever Hinge Screw Nut.. | 05 |
| 202598 | 11305 | Ruffling Blade Lever Spring..... | 05 |
| *200771 | — | Ruffling Blade Lever Spring Stud..... | 05 |
| 202599B | 11305 | Ruffling Blade Lever Spring Stud Bracket with 200771..... | 05 |
| 201566B | 11305 | Ruffling Blade Lever Spring Thumb Nut | 05 |
| 202603 | 11305 | Ruffling Blade Lever Spring Thumb Nut Washer..... | 01 |
| 202603 | 11305 | Ruffling Blade Lever Spring Washer.... | 05 |
| 226410 | 11211 | Switching Lever with 200043c, 200162, 200284 and 200909E..... | 1 60 |
| 226411 | 11211 | Switching Lever 226410 with 203935, 226348 and 226413..... | 3 00 |
| 226431 | — | Switching Lever 226411 with 226354.... | 4 00 |
| 226347 | 11203 | Switching Lever Bell Crank..... | 50 |
| 226348 | 11206 | Switching Lever Bell Crank 226347 with 200659c and 201528c..... | 60 |
| 200909E | 11203 | Switching Lever Bell Crank Hinge Screw | 08 |
| 202668 | 11306 | Switching Lever Bell Crank Slide Block | 15 |
| 200659c | 11203 | Switching Lever Bell Crank Slide Block Screw Stud..... | 05 |
| 201528c | 11203 | Switching Lever Bell Crank Slide Block Screw Stud Nut..... | 04 |
| 202104 | 11204 | Switching Lever Bell Crank Slide Block Screw Stud Washer..... | 01 |
| 226413 | 11215 | Switching Lever Latch..... | 50 |
| 200284B | 11204 | Switching Lever Latch Hinge Screw.... | 05 |

On the Library of the Needle Co.

| No. | Plate | Name | Each |
|---------|-------|--|-------|
| 203935 | 11215 | Switching Lever Latch Spring..... | 02 |
| 202027 | 11215 | Switching Lever Latch Spring Pin..... | 01 |
| 200162 | 11203 | Switching Lever Latch Stop Screw..... | 04 |
| 200043c | 10436 | Switching Lever Pinch Screw..... | 04 |
| 226353 | 11211 | Switching Lever Shaft..... | 35 |
| 226354 | 11211 | Switching Lever Shaft 226353 with 226355 and 226356..... | 1 00 |
| 202305c | 10436 | Switching Lever Shaft Center..... | 06 |
| 200043c | 10436 | Switching Lever Shaft Center Set Screw | 04 |
| 226355 | 11211 | Switching Lever Shaft Spring..... | 30 |
| 226356 | 11204 | Switching Lever Shaft Spring Collar with 200363c..... | 25 |
| 200363c | 11204 | Switching Lever Shaft Spring Collar Set Screw..... | 03 |
| 211011 | 11358 | Throat Plate (formerly "99 F") 50 needle hole, for needle sizes 3 to 5, made in gauges from 1/4 in. to 3/4 in. in steps of 1/16 in., for 203462 and 211010..... | 1 25 |
| 226756 | --- | Ruffling Combination No. 95 complete... | 20 00 |

No. 226765 COMBINATION

(FORMERLY No. 96)

For Banding Skirts and Underwear. Folds a Strip on the Bottom,
Folds Down the Edge of the Garment and Ruffles It and
Guides a Puckering Tape Between Them. The Puckering
Tape May Be Switched Into the Seam, For a Short
Distance, To Prevent Pulling Out.

When Ordering, State Gauge Required.

| No. | Plate | Name | Each |
|---------|-------|--|-------|
| 211030 | 11356 | Feed Dog (formerly "134") for 211028 and 211029..... | 1 75 |
| 226757 | 11516 | Folder (plate) with two 200173..... | 4 00 |
| 226762 | 11517 | Folder (upper) (on shank)..... | 2 50 |
| 226763 | 11547 | Folder 226757 with 226650 and 226758 to 226762..... | 15 00 |
| 202090 | 10443 | Presser Foot Hinge Pin..... | 01 |
| 226752 | --- | Presser Foot Plate..... | 1 25 |
| 226466 | 11512 | Presser Foot Plate Spring..... | 025 |
| 200174b | 11204 | Presser Foot Plate Spring Screw..... | 02 |
| 226753 | 11545 | Presser Foot complete (hinged) Nos. 200174b, 202090, 226566 and 226752.... | 2 25 |
| 226758 | 11546 | Puckering Tape Guide with two 200174b | 2 00 |
| 226759 | 11546 | Puckering Tape Guide Switching Lever | 0 50 |
| 226650 | 11527 | Puckering Tape Guide Stop..... | 25 |
| 200174b | 11204 | Puckering Tape Guide Stop Screw..... | 02 |
| 226760 | 11528 | Ruffling Separating Blade..... | 50 |
| 226761 | 11546 | Ruffling Separating Blade Bracket with two each 200174b and 200183..... | 6 00 |
| 226764 | 11546 | Ruffling Blade..... | 50 |
| 202610 | 11305 | Ruffling Blade Clamp..... | 02 |
| 200174b | 11204 | Ruffling Blade Clamp Screw..... | 02 |
| 202597 | 11306 | Ruffling Blade Lever with 202610 and two 200174b..... | 1 25 |
| 226403 | --- | Ruffling Blade Lever Bracket (adjust- able)..... | 25 |
| 226404 | 11213 | Ruffling Blade Lever Bracket 226403 with 202599b..... | 50 |
| 226415 | 11216 | Ruffling Blade Lever Bracket 226404 with 200289, 201537, 201566b, 202597, 202598 and two 202603..... | 1 85 |
| 226405 | 11213 | Ruffling Blade Lever Bracket Crank with two each 200098A, 202600 and 202602.. | 1 00 |
| 226406 | 11211 | Ruffling Blade Lever Bracket Crank 226405 with 202613 and 226407..... | 2 25 |

From the library of: Dillard Medical Center

| No. | Plate | Name | Each |
|---------|-------|---|------|
| 202602 | 11215 | Ruffling Blade Lever Bracket Crank Position Pin..... | 05 |
| 202613 | 11213 | Ruffling Blade Lever Bracket Spring.... | 03 |
| 200101D | 11305 | Ruffling Blade Lever Bracket Spring Screw | 04 |
| *202973 | — | Ruffling Blade Lever Bracket Position Collar | — |
| *202974 | — | Ruffling Blade Lever Bracket Position Collar Position Pin..... | — |
| 200098A | 10438 | Ruffling Blade Lever Bracket Screw.... | 03 |
| 202600 | 11202 | Ruffling Blade Lever Bracket Screw Washer | 01 |
| 226407 | 11215 | Ruffling Blade Lever Bracket Shaft with 200101d, 202973 and 202974..... | 1 25 |
| 226408 | 11211 | Ruffling Blade Lever Bracket Shaft 226407 with 226406 and 226415..... | 4 00 |
| 200289 | 11202 | Ruffling Blade Lever Hinge Screw..... | 05 |
| 201537 | 11202 | Ruffling Blade Lever Hinge Screw Nut... | 03 |
| 202598 | 11305 | Ruffling Blade Lever Spring..... | 05 |
| *200771 | — | Ruffling Blade Lever Spring Stud..... | — |
| 202599B | 11305 | Ruffling Blade Lever Spring Stud Bracket with 200771..... | 25 |
| 201566B | 11305 | Ruffling Blade Lever Spring Thumb Nut | 05 |
| 202603 | 11305 | Ruffling Blade Lever Spring Washer..... | 01 |
| 226409 | 11213 | Stop Block..... | 35 |
| 226410 | 11211 | Switching Lever with 200043c, 200162, 200284 and 200909e..... | 1 60 |
| 226411 | 11211 | Switching Lever 226410 with 203935, 226348 and 226413..... | 3 00 |
| 226431 | — | Switching Lever 226411 with 226354..... | 4 00 |
| 226347 | 11203 | Switching Lever Bell Crank..... | 50 |
| 226348 | 11206 | Switching Lever Bell Crank 226347 with 200659c and 201528b..... | 60 |
| 200909E | 11203 | Switching Lever Bell Crank Hinge Screw | 08 |
| 202668 | 11306 | Switching Lever Bell Crank Slide Block | 15 |
| 200659c | 11203 | Switching Lever Bell Crank Slide Block Screw Stud..... | 05 |
| 201528c | 11203 | Switching Lever Bell Crank Slide Block Screw Stud Nut..... | 04 |
| 202104 | 11204 | Switching Lever Bell Crank Slide Block Screw Stud Washer..... | 01 |
| 226413 | 11215 | Switching Lever Latch..... | 50 |
| 200284B | 11204 | Switching Lever Latch Hinge Screw.... | 05 |
| 203935 | 11215 | Switching Lever Latch Spring..... | 02 |
| 202027 | 11215 | Switching Lever Latch Spring Pin..... | 01 |
| 200162D | 11203 | Switching Lever Latch Stop Screw..... | 04 |
| 200043c | 10436 | Switching Lever Pinch Screw..... | 04 |
| 226353 | 11211 | Switching Lever Shaft..... | 35 |
| 226354 | 11211 | Switching Lever Shaft 226353 with 226355 and 226356..... | 1 00 |

| No. | Plate | Name | Each |
|---------|-------|---|-------|
| 202305c | 10436 | Switching Lever Shaft Center..... | 06 |
| 200043c | 10436 | Switching Lever Shaft Center Set Screw | 04 |
| 226355 | 11211 | Switching Lever Shaft Spring..... | 30 |
| 226356 | 11204 | Switching Lever Shaft Spring Collar with 200363c | 25 |
| 200363c | 11204 | Switching Lever Shaft Spring Collar Set Screw | 03 |
| 211028 | 11356 | Throat Plate (formerly "134-F") 50 needle hole, for needle sizes 3 to 5, made in gauges from $\frac{1}{4}$ in. to $\frac{5}{16}$ in. in steps of $\frac{1}{32}$ in., for 203462 and 211030... | 1 25 |
| 211029 | 11356 | Throat Plate (formerly "134-F") 46 needle hole, for needle sizes 5 to 7, made in gauges from $\frac{1}{4}$ in. to $\frac{5}{16}$ in. in steps of $\frac{1}{32}$ in., for 203462 and 211030... | 1 25 |
| 226765 | — | Ruffling Combination No. 96 complete... | 21 00 |

No. 226772 COMBINATION

(FORMERLY NO. 98)

For Skirt Work (Has Three Folders and a Guide) Places a Ruffle On the Bottom of Skirt with a Piping and Folded Strip for a Heading. Folds Up the Edge of Skirt, Folds and Guides a Piping, Folds a Strip and Lays a Ruffle Between Them.

When Ordering, State Gauge Required.

| No. | Plate | Name | Each |
|---------|-------|--|------|
| 226463 | 11223 | Attachment Arm Switch with two 200183B | 1 00 |
| 226464 | 11223 | Attachment Arm Switch Bracket with 200268B, 200336B, 201531, 201537 and 226467 | 1 50 |
| 226465 | 11224 | Attachment Arm Switch Bracket 226464 with 226463 | 2 50 |
| 200157B | 11204 | Attachment Arm Switch Bracket Screw | 05 |
| 200268B | 11223 | Attachment Arm Switch Hinge Screw | 10 |
| 201531 | 11223 | Attachment Arm Switch Hinge Screw Nut | 03 |
| 226467 | 11223 | Attachment Arm Switch Hinge Screw Spring Washer | 05 |
| 200336D | 10441 | Attachment Arm Switch Stop Screw | 04 |
| 201537 | 11202 | Attachment Arm Switch Stop Screw Cheek Nut | 03 |
| 226769 | 11545 | Attachment Arm Switch Folder (on shank) folds the piping | 1 50 |
| 200183B | 11221 | Attachment Arm Switch Strip Guide Screw | 02 |
| 211022 | 11354 | Feed Dog, for 211021 | 75 |
| 226766 | 11543 | Folder (lower) (plate) with 200305 | 2 00 |
| 226768 | 11543 | Folder 226766 with 226695 and 226767 | 3 50 |
| 226767 | 11547 | Guide (on shank) | 75 |
| 226695 | 11534 | Guide Switching Lever with two 200183 | 60 |
| 226771 | 11548 | Presser Foot (strip folder) | 3 00 |
| 226770 | 11548 | Ruffling Blade | 35 |
| 202610 | 11305 | Ruffling Blade Clamp | 02 |
| 200174D | 11204 | Ruffling Blade Clamp Screw | 02 |
| 202597 | 11306 | Ruffling Blade Lever with 202610 and two 200174D | 1 25 |
| 202837 | 11218 | Ruffling Blade Lever Bracket with 202599B and two 202602 | 1 75 |
| 202602 | 11215 | Ruffling Blade Lever Bracket Pin | 05 |

| No. | Plate | Name | Each |
|---------|-------|--|------|
| *202973 | --- | Ruffling Blade Lever Bracket Position Collar | --- |
| *202974 | --- | Ruffling Blade Lever Bracket Position Collar Position Pin | --- |
| 226407 | 11215 | Ruffling Blade Lever Bracket Shaft with 200101D, 202973 and 202974 | 1 25 |
| 226429 | 11211 | Ruffling Blade Lever Bracket Shaft 226407 with 200289B, 201537, 201566B, 202597, 202598, 202613, 202837 and two 202603 | 4 75 |
| 202613 | 11213 | Ruffling Blade Lever Bracket Spring | 03 |
| 200101D | 11305 | Ruffling Blade Lever Bracket Spring Screw | 04 |
| 200289B | 11202 | Ruffling Blade Lever Hinge Screw | 05 |
| 201537 | 11202 | Ruffling Blade Lever Hinge Screw Nut | 03 |
| 202598 | 11305 | Ruffling Blade Lever Spring | 05 |
| *200771 | --- | Ruffling Blade Lever Spring Stud | --- |
| 202599B | 11305 | Ruffling Blade Lever Spring Stud Bracket with 200771 | 25 |
| 201566B | 11305 | Ruffling Blade Lever Spring Thumb Nut | 05 |
| 202603 | 11305 | Ruffling Blade Lever Spring Thumb Nut Washer | 01 |
| 202603 | 11305 | Ruffling Blade Lever Spring Washer | 01 |
| 226410 | 11211 | Switching Lever with 200043c, 200162, 200284 and 200909E | 1 60 |
| 226411 | 11211 | Switching Lever 226410 with 203935, 226348 and 226413 | 3 00 |
| 226431 | --- | Switching Lever 226411 with 226351 | 4 00 |
| 226347 | 11203 | Switching Lever Bell Crank | 50 |
| 226348 | 11206 | Switching Lever Bell Crank 226347 with 200659c and 201528c | 60 |
| 200909E | 11203 | Switching Lever Bell Crank Hinge Screw | 08 |
| 202668 | 11306 | Switching Lever Bell Crank Slide Block | 15 |
| 200659c | 11203 | Switching Lever Bell Crank Slide Block Screw Stud | 05 |
| 201528c | 11203 | Switching Lever Bell Crank Slide Block Screw Stud Nut | 04 |
| 202104 | 11204 | Switching Lever Bell Crank Slide Block Screw Stud Washer | 01 |
| 226413 | 11215 | Switching Lever Latch | 50 |
| 200284B | 11204 | Switching Lever Latch Hinge Screw | 05 |
| 203935 | 11215 | Switching Lever Latch Spring | 02 |
| 202027 | 11215 | Switching Lever Latch Spring Pin | 01 |
| 200162 | 11203 | Switching Lever Latch Stop Screw | 04 |
| 200043c | 10436 | Switching Lever Pinch Screw | 04 |
| 226353 | 11211 | Switching Lever Shaft | 35 |
| 226354 | 11211 | Switching Lever Shaft 226353 with 226355 and 226356 | 1 00 |

From the library of Diamond Needle Corp.

| No. | Plate | Name | Each |
|---------|-------|--|-------|
| 202305c | 10436 | Switching Lever Shaft Center..... | 06 |
| 200043c | 10436 | Switching Lever Shaft Center Set Screw | 04 |
| 226355 | 11211 | Switching Lever Shaft Spring..... | 30 |
| 226356 | 11204 | Switching Lever Shaft Spring Collar with 200363c | 25 |
| 200363c | 11204 | Switching Lever Shaft Spring Collar Set Screw | 03 |
| 211021 | 11354 | Throat Plate (formerly "22 F") 50 needle hole, for needle sizes 3 to 5, made in gauges from $\frac{1}{4}$ in. to $\frac{7}{8}$ in. in steps of $\frac{1}{16}$ in., for 203462 and 211022..... | 1 25 |
| 226772 | --- | Ruffling Combination No. 98 complete... | 21 75 |

No. 226780 COMBINATION

(FORMERLY No. 99)

For Banding. Has Top and Bottom Folders. Folds the Four Edges In, Forming a Band and Guides and Ruffles a Garment on the Left.

When Ordering, State Gauge Required.

| No. | Plate | Name | Each |
|---------|-------|--|------|
| 211017 | 11357 | Feed Dog (formerly "9-F") for 211015 and 211016 | 85 |
| 226773 | 11543 | Folder (plate) with two 200173..... | 3 50 |
| 226776 | 11543 | Folder 226773 with 226774 and 226775.... | 5 50 |
| 200157B | 11204 | Folder Screw..... | 05 |
| 226774 | 11543 | Guide (on shank) with two 200174b..... | 2 00 |
| 200173 | 11215 | Guide Screw..... | 04 |
| 226779 | 11536 | Presser Foot (strip folder)..... | 3 00 |
| 226775 | 11543 | Ruffling Separating Blade..... | 50 |
| 200174b | 11204 | Ruffling Separating Blade Screw..... | 02 |
| 226777 | 11547 | Ruffling Blade..... | 35 |
| 226687 | 11532 | Ruffling Blade Lever Bracket..... | 50 |
| 202574 | 11306 | Ruffling Blade Regulating Lever Shaft Collar with 200380c..... | 15 |
| 200380c | 11202 | Ruffling Blade Regulating Lever Shaft Collar Set Screw..... | 02 |
| 226688 | 11534 | Ruffling Blade Lever Bracket 226687 with 201566b, 202598, 226683 and two 202603 | 1 75 |
| 226339 | 11202 | Ruffling Blade Regulating Lever with two 200382c | 1 75 |
| 226778 | 11548 | Ruffling Blade Lever Shaft..... | 25 |
| 226410 | 11211 | Switching Lever with 200043c, 200162, 200284 and 200909E..... | 1 60 |
| 226411 | 11211 | Switching Lever 226410 with 203935, 226348 and 226413..... | 3 00 |
| 226431 | --- | Switching Lever 226411 with 226354.... | 4 00 |
| 226347 | 11203 | Switching Lever Bell Crank..... | 50 |
| 226348 | 11206 | Switching Lever Bell Crank 226347 with 200659c and 201528c..... | 60 |
| 200909E | 11203 | Switching Lever Bell Crank Hinge Screw | 08 |
| 202668 | 11306 | Switching Lever Bell Crank Slide Block | 15 |
| 200659c | 11203 | Switching Lever Bell Crank Slide Block Screw Stud..... | 05 |
| 201528c | 11203 | Switching Lever Bell Crank Slide Block Screw Stud Nut..... | 04 |
| 202104 | 11204 | Switching Lever Bell Crank Slide Block Screw Stud Washer..... | 01 |

From the library of Diamond Needle Co.

| No. | Plate | Name | Each |
|---------|-------|---|-------|
| 226413 | 11215 | Switching Lever Latch..... | 50 |
| 200284b | 11204 | Switching Lever Latch Hinge Screw.... | 05 |
| 203935 | 11215 | Switching Lever Latch Spring..... | 02 |
| 202027 | 11215 | Switching Lever Latch Spring Pin..... | 01 |
| 200162 | 11203 | Switching Lever Latch Stop Screw..... | 04 |
| 200043c | 10436 | Switching Lever Pinch Screw..... | 04 |
| 226353 | 11211 | Switching Lever Shaft..... | 35 |
| 226354 | 11211 | Switching Lever Shaft 226353 with 226355 and 226356..... | 1 00 |
| 202305c | 10436 | Switching Lever Shaft Center..... | 03 |
| 200043c | 10436 | Switching Lever Shaft Center Set Screw | 04 |
| 226355 | 11211 | Switching Lever Shaft Spring..... | 30 |
| 226356 | 11204 | Switching Lever Shaft Spring Collar with 200363c..... | 25 |
| 200363c | 11204 | Switching Lever Shaft Spring Collar Set Screw..... | 03 |
| 211015 | 11357 | Throat Plate (formerly "9-F") 50 needle hole, for needle sizes 3 to 5, made in gauges 1, 1 $\frac{1}{32}$, 1 $\frac{1}{16}$, 1 $\frac{1}{8}$ and 1 $\frac{1}{4}$ in., for 203462 and 211017..... | 1 50 |
| 211016 | 11357 | Throat Plate (formerly "9-F") 46 needle hole, for needle sizes 5 to 7, made in gauges 1, 1 $\frac{1}{32}$, 1 $\frac{1}{16}$, 1 $\frac{1}{8}$ and 1 $\frac{1}{4}$ in., for 203462 and 211017..... | 1 50 |
| 226780 | --- | Ruffling Combination No. 99 complete... | 16 00 |

No. 226788 COMBINATION

(FORMERLY No. 100)

For Aprons and Ladies' Underwear. Folds the Band and Ruffles
the Apron or Garment Between the Folded Edges.

When Ordering, State Gauge Required.

| No. | Plate | Name | Each |
|---------|-------|---|-------|
| 211041 | 11358 | Feed Dog (formerly "10-F") for 211894 and 211895..... | 85 |
| 226785 | 11222 | Folder and Separating Blade (on shank) (short strip can be used)..... | 12 00 |
| 203075 | 11519 | Folder Base Plate..... | 40 |
| 226787 | 11549 | Presser Foot..... | 1 50 |
| 226786 | 11549 | Ruffling Blade..... | 35 |
| 226330 | 11202 | Ruffling Blade Clamp..... | 05 |
| 200179b | 11208 | Ruffling Blade Clamp Screw..... | 02 |
| 202574 | 11306 | Ruffling Blade Driving Lever Shaft Collar with 200380c..... | 15 |
| 200380c | 11202 | Ruffling Blade Driving Lever Shaft Collar Set Screw..... | 02 |
| 226458 | 11223 | Ruffling Blade Lever with 226330 and two 200179b..... | 1 25 |
| *203340 | 11202 | Ruffling Blade Lever Bracket (adjust- able)..... | 25 |
| 203341 | 11306 | Ruffling Blade Lever Bracket 203340 with 202599b..... | 50 |
| 203342 | 11306 | Ruffling Blade Lever Bracket Crank with two each 200098b, 200382c and 202600 | 75 |
| 200382c | 11305 | Ruffling Blade Lever Bracket Crank Set Screw..... | 02 |
| 200098b | 10438 | Ruffling Blade Lever Bracket Screw.... | 03 |
| 202600 | 11202 | Ruffling Blade Lever Bracket Screw Washer..... | 01 |
| 200289 | 11202 | Ruffling Blade Lever Hinge Screw..... | 05 |
| 201537 | 11202 | Ruffling Blade Lever Hinge Screw Nut.. | 03 |
| 202598 | 11305 | Ruffling Blade Lever Spring..... | 05 |
| *200771 | --- | Ruffling Blade Lever Spring Stud..... | --- |
| 202599b | 11305 | Ruffling Blade Lever Spring Stud Bracket with 200771..... | 25 |
| 201566b | 11305 | Ruffling Blade Lever Spring Thumb Nut | 05 |
| 202603 | 11305 | Ruffling Blade Lever Spring Thumb Nut Washer..... | 01 |
| 202603 | 11305 | Ruffling Blade Lever Spring Washer.... | 01 |
| 202605b | 11306 | Ruffling Blade Lifting Lever..... | 25 |
| 200168c | 11306 | Ruffling Blade Lifting Lever Set Screw.. | 02 |
| 202606 | 11303 | Ruffling Blade Lifting Lever Stud (adjustable) with 200072c and 200168c | 45 |
| 226340 | 11202 | Ruffling Blade Lifting Lever Stud 202606 with 202605b..... | 70 |

From the library of: Diamond Needle Corp

| No. | Plate | Name | Each |
|---------|-------|--|-------|
| 200072c | 11010 | Ruffling Blade Lifting Lever Stud Pinch Screw | 03 |
| 226345 | 11211 | Switching Lever with 200043c, 200284b, 200907b, 200909e, 226338 and three 200162b | 1 60 |
| 226346 | 11211 | Switching Lever 226345 with 202600, and 226348 to 226352 | 3 75 |
| 226357 | — | Switching Lever 226346 with 226354 | 4 75 |
| 226347 | 11203 | Switching Lever Bell Crank | 50 |
| 226348 | 11206 | Switching Lever Bell Crank 226347 with 200659c and 201528b | 60 |
| 200909e | 11203 | Switching Lever Bell Crank Hinge Screw | 08 |
| 226349 | 11203 | Switching Lever Bell Crank Slide Block | 25 |
| 200659c | 11203 | Switching Lever Bell Crank Slide Block Screw Stud | 05 |
| 201528b | 11203 | Switching Lever Bell Crank Slide Block Screw Stud Nut | 04 |
| 202600 | 11203 | Switching Lever Bell Crank Slide Block Screw Stud Washer | 01 |
| 226350 | 11201 | Switching Lever Handle | 75 |
| 200162b | 11203 | Switching Lever Handle Screw | 04 |
| 226351 | 11201 | Switching Lever Latch | 75 |
| 200284b | 11204 | Switching Lever Latch Hinge Screw | 05 |
| 226352 | 11203 | Switching Lever Latch Spring | 05 |
| 200907e | 11204 | Switching Lever Latch Spring Screw | 02 |
| 200162b | 11203 | Switching Lever Latch Stop Screw | 04 |
| 200043c | 10436 | Switching Lever Pinch Screw | 04 |
| 226353 | 11211 | Switching Lever Shaft | 35 |
| 226354 | 11211 | Switching Lever Shaft 226353 with 226355 and 226356 | 1 00 |
| 202305c | 10436 | Switching Lever Shaft Center | 06 |
| 200043c | 10436 | Switching Lever Shaft Center Set Screw | 04 |
| 226355 | 11211 | Switching Lever Shaft Spring | 30 |
| 226356 | 11204 | Switching Lever Shaft Spring Collar with 200363c | 25 |
| 200363c | 11204 | Switching Lever Shaft Spring Collar Set Screw | 03 |
| 226778 | 11548 | Ruffling Blade Regulating Lever Shaft | 25 |
| 202574 | 11306 | Ruffling Blade Regulating Lever Shaft Collar | 15 |
| 211894 | 11549 | Throat Plate (formerly "70-F") 50 needle hole, for needle sizes 3 to 5, made in gauges $1\frac{1}{8}$, $1\frac{3}{8}$ and $1\frac{5}{8}$ in., for 203462 and 211041 | 1 50 |
| 211895 | 11549 | Throat Plate (formerly "10-F") 46 needle hole, for needle sizes 5 to 7, made in gauges $1\frac{1}{8}$, $1\frac{3}{8}$ and $1\frac{5}{8}$ in., for 203462 and 211041 | 1 50 |
| 226788 | — | Ruffling Combination No. 100 complete | 19 00 |

No. 226789 COMBINATION

FORMERLY No. 101

For Skirt Work. Has Two Guides for Laying a Plait in the Body of a Skirt and Sewing a Ruffle In It.

When Ordering, State Gauge Required.

| No. | Plate | Name | Each |
|---------|-------|--|------|
| 226393 | 11214 | Attachment Arm Switch (to the right) with two 200187 | 1 25 |
| 226394 | 11214 | Attachment Arm Switch 226393 with 226397 and 226399 | 2 15 |
| 226395 | 11214 | Attachment Arm Switch Bracket 200272b, 228032 and two 200911 | 1 25 |
| 226396 | 11211 | Attachment Arm Switch Bracket 226395 with 226394 | 3 35 |
| 200911 | 11213 | Attachment Arm Switch Bracket Screw | 05 |
| 200272b | 11213 | Attachment Arm Switch Hinge Screw | 08 |
| 228032 | 11213 | Attachment Arm Switch Hinge Screw Washer | 01 |
| 226397 | 11213 | Attachment Arm Switch Latch with 200272b and 226398 | 85 |
| 200272b | 11213 | Attachment Arm Switch Hinge Screw | 08 |
| 226398 | 11213 | Attachment Arm Switch Hinge Screw Washer | 01 |
| 226399 | 11213 | Attachment Arm Switch Latch Spring | 05 |
| 226419 | 11217 | Bed Switch Locking Plate with two 200173 | 75 |
| 226560 | 11511 | Bed Switch Guide (on shank) | 75 |
| 226416 | 11217 | Bed Switch with two 200173 | 60 |
| 200305 | 11204 | Bed Switch Hinge Screw | 04 |
| 200157b | 11204 | Bed Switch Locking Plate Screw | 05 |
| 200173 | 11215 | Bed Switch Locking Plate Folder Screw | 04 |
| 226792 | — | Bed Switch Locking Plate 226419 with 226416 and 226560 | 1 35 |
| 211010 | 11355 | Feed Dog (formerly "99") for 211009 | 60 |
| 226561 | 11511 | Guide and Separating Blade (on shank) | 1 00 |
| 226563 | 11511 | Guide and Switching Blade Bracket (intermediate) with two 200183 | 60 |
| 226564 | 11224 | Guide and Switching Blade Bracket 226563 with 226561 | 1 60 |
| 200187 | 11213 | Guide and Switching Blade Bracket Screw | 04 |

| No. | Plate | Name | Each |
|---------|-------|---|------|
| 202090 | 10443 | Presser Foot Hinge Pin..... | 01 |
| 226565 | — | Presser Foot Plate..... | 1 25 |
| 226566 | 11512 | Presser Foot Plate Spring..... | 25 |
| 200174D | 11204 | Presser Foot Plate Spring Screw..... | 02 |
| 226567 | 11512 | Presser Foot complete, Nos. 200174D, 202090, 226565 and 226566..... | 2 25 |
| 202597 | 11306 | Presser Foot Lever with 202610 and two 200174D | 1 25 |
| 202837 | 11218 | Ruffling Blade Lever Bracket with 202599B and two 202602..... | 1 75 |
| 202602 | 11215 | Ruffling Blade Lever Bracket Pin..... | 05 |
| *202973 | — | Ruffling Blade Lever Bracket Position Collar | — |
| *202974 | — | Ruffling Blade Lever Bracket Position Collar Position Pin..... | — |
| 226407 | 11215 | Ruffling Blade Lever Bracket Shaft with 200101B, 202973 and 202974..... | 1 25 |
| 226429 | 11211 | Ruffling Blade Lever Bracket Shaft 226407 with 200289B, 201537, 201566B, 202597, 202598, 202613, 202837 and two 202603 | 4 75 |
| 202613 | 11213 | Ruffling Blade Lever Bracket Spring.... | 03 |
| 200101B | 11305 | Ruffling Blade Lever Bracket Spring Screw | 04 |
| 200289B | 11202 | Ruffling Blade Lever Hinge Screw..... | 05 |
| 201537 | 11202 | Ruffling Blade Lever Hinge Screw Nut.. | 03 |
| 202598 | 11305 | Ruffling Blade Lever Spring..... | 05 |
| *200771 | — | Ruffling Blade Lever Spring Stud..... | — |
| 202599B | 11305 | Ruffling Blade Lever Spring Stud Bracket with 200771..... | 25 |
| 201566B | 11305 | Ruffling Blade Lever Spring Thumb Nut | 05 |
| 202603 | 11305 | Ruffling Blade Lever Spring Thumb Nut Washer | 01 |
| 202603 | 11305 | Ruffling Blade Lever Spring Washer.... | 01 |
| 226410 | 11211 | Switching Lever with 200043C, 200162, 200284 and 200909E..... | 1 60 |
| 226411 | 11211 | Switching Lever 226410 with 203935, 226348 and 226413..... | 3 00 |
| 226431 | — | Switching Lever 226411 with 226354..... | 4 00 |
| 226347 | 11203 | Switching Lever Bell Crank..... | 50 |
| 226348 | 11206 | Switching Lever Bell Crank 226347 with 200659C and 201528C..... | 60 |
| 200909E | 11203 | Switching Lever Bell Crank Hinge Screw | 08 |
| 202668 | 11306 | Switching Lever Bell Crank Slide Block | 15 |
| 200659C | 11203 | Switching Lever Bell Crank Slide Block Screw Stud..... | 05 |
| 201528C | 11203 | Switching Lever Bell Crank Slide Block Screw Stud Nut..... | 04 |
| 202104 | 11204 | Switching Lever Bell Crank Slide Block Screw Stud Washer..... | 01 |

| No. | Plate | Name | Each |
|---------|-------|--|-------|
| 226413 | 11215 | Switching Lever Latch..... | 50 |
| 200284B | 11204 | Switching Lever Latch Hinge Screw.... | 05 |
| 203935 | 11215 | Switching Lever Latch Spring..... | 02 |
| 202027 | 11215 | Switching Lever Latch Pin..... | 01 |
| 200162 | 11203 | Switching Lever Latch Stop Screw..... | 04 |
| 200043C | 10436 | Switching Lever Pinch Screw..... | 04 |
| 226353 | 11211 | Switching Lever Shaft..... | 35 |
| 226354 | 11211 | Switching Lever Shaft 226353 with 226355 and 226356..... | 1 00 |
| 202305C | 10436 | Switching Lever Shaft Center..... | 06 |
| 200043C | 10436 | Switching Lever Shaft Center Set Screw | 04 |
| 226355 | 11211 | Switching Lever Shaft Spring..... | 30 |
| 226356 | 11204 | Switching Lever Shaft Spring Collar with 200363C | 25 |
| 200363C | 11204 | Switching Lever Shaft Spring Collar Set Screw | 03 |
| 211009 | 11355 | Throat Plate (formerly "99-F-1") 50 needle hole, for needle sizes 3 to 5, made in gauges from $\frac{1}{4}$ in. to $\frac{3}{8}$ in. in steps of $\frac{1}{32}$ in., for 203462 and 211010..... | 1 25 |
| 226789 | — | Ruffling Combination No. 101 complete.. | 17 00 |

Numerical List of Parts

| No. | Plate | Each | No. | Plate | Each |
|---------|-------|------|---------|-------|------|
| 200002E | 10436 | 07 | 200243E | 11005 | 08 |
| 200006E | 11007 | 07 | 200246 | 11226 | 08 |
| 200016E | 10431 | 06 | 200257D | 11032 | 08 |
| 200027C | 11005 | 04 | 200268B | 11223 | 10 |
| 200031C | 10438 | 04 | 200271E | 10438 | 05 |
| 200033C | 11307 | 05 | 200272B | 11213 | 08 |
| 200042C | 11031 | 05 | 200278 | 10710 | 05 |
| 200043C | 10436 | 04 | 200284B | 11204 | 05 |
| 200045E | 11005 | 03 | 200289B | 11202 | 05 |
| 200048B | 11221 | 04 | 200291E | 10438 | 05 |
| 200053C | 10435 | 04 | 200300 | 10444 | 04 |
| 200054E | 10434 | 03 | 200305 | 11204 | 04 |
| 200062 | 10434 | 07 | 200309E | 10443 | 04 |
| 200068 | 14501 | 03 | 200319C | 10444 | 04 |
| 200072C | 11010 | 03 | 200328C | 10434 | 04 |
| 200074D | 10441 | 03 | 200335C | 10434 | 04 |
| 200078C | 10438 | 03 | 200336 | 10441 | 04 |
| 200079 | 10710 | 02 | 200338C | 11303 | 04 |
| 200086C | 10441 | 03 | 200342 | 11303 | 03 |
| 200092B | 11204 | 03 | 200362C | 10441 | 03 |
| 200093B | 11217 | 03 | 200363C | 11204 | 03 |
| 200098A | 10438 | 03 | 200366C | 10444 | 02 |
| 200101B | 11305 | 04 | 200368 | 10444 | 02 |
| 200106E | 10435 | 02 | 200369D | 11220 | 06 |
| 200113C | 10436 | 03 | 200378C | 10436 | 02 |
| 200125C | 11303 | 02 | 200380C | 11202 | 02 |
| 200126C | 11203 | 02 | 200382C | 11305 | 02 |
| 200131C | 11032 | 02 | 200383C | 10435 | 02 |
| 200135E | 10444 | 03 | 200385C | 10435 | 02 |
| 200141 | 13084 | 02 | 200393C | 11007 | 02 |
| 200157B | 11204 | 05 | 200430C | 11031 | 08 |
| 200160B | 11213 | 04 | 200437C | 10436 | 06 |
| 200162 | 11203 | 04 | 200439C | 10434 | 05 |
| 200164B | 11208 | 02 | 200483B | 11514 | 06 |
| 200168C | 11306 | 02 | 200491B | 10441 | 25 |
| 200169 | 11204 | 04 | 200502B | 11303 | 25 |
| 200170B | 11514 | 04 | 200503 | 11010 | 05 |
| 200173 | 11215 | 04 | 200504 | 11010 | 05 |
| 200174D | 11204 | 02 | 200516 | 10434 | 08 |
| 200175 | 11202 | 02 | 200537C | 11307 | 10 |
| 200178D | 11203 | 02 | 200550C | 10441 | 08 |
| 200179D | 11208 | 02 | 200555 | 11007 | 05 |
| 200183B | 11221 | 02 | 200566 | 11512 | 06 |
| 200187B | 11213 | 04 | 200567 | 11507 | 05 |
| 200214E | 10435 | 12 | 200570E | 10434 | 05 |

Numerical List of Parts

| No. | Plate | Each | No. | Plate | Each |
|---------|------------|------|---------|------------|------|
| 200575 | 10710..... | 05 | 202091 | 10444..... | 05 |
| 200577 | 10444..... | 02 | 202092 | 10444..... | 01 |
| 200581 | 10444..... | 02 | 202098 | 10444..... | 05 |
| 200582 | 11305..... | 02 | 202104 | 11204..... | 01 |
| 200593 | 11228..... | 02 | 202126 | 10434..... | 01 |
| 200594c | 11228..... | 02 | 202211 | 10279..... | 02 |
| 200600 | 11228..... | 02 | 202248 | 10710..... | 05 |
| 200609c | 10434..... | 03 | 202258 | 11003..... | 08 |
| 200616E | 11228..... | 02 | 202259 | 11003..... | 08 |
| 200632B | 10493..... | 20 | *202276 | | --- |
| 200658c | 11010..... | 10 | 202299 | 10279..... | 01 |
| 200659c | 11203..... | 05 | 202305c | 10436..... | 06 |
| 200668c | 10438..... | 06 | 202325 | 11031..... | 05 |
| 200684c | 10444..... | 04 | 202402 | 10443..... | 05 |
| *200771 | | --- | 202407 | 10443..... | 05 |
| 200798 | | --- | 202413 | 11010..... | 05 |
| 200840 | 11007..... | 10 | 202574 | 11306..... | 15 |
| 200855E | 11220..... | 02 | 202597 | 11306..... | 1 25 |
| 200892 | 11005..... | 10 | 202598 | 11305..... | 05 |
| 200907B | 11204..... | 02 | 202599B | 11305..... | 25 |
| 200909E | 11203..... | 08 | 202600 | 11202..... | 01 |
| 200911D | 11213..... | 05 | 202602 | 11215..... | 05 |
| 200924 | 11541..... | 03 | 202603 | 11305..... | 01 |
| 201512 | | 05 | 202605B | 11306..... | 25 |
| 201519c | 11010..... | 03 | 202606 | 11303..... | 45 |
| 201522 | 10436..... | 03 | 202607 | 11307..... | 1 50 |
| 201524c | 10436..... | 03 | 202608 | 11303..... | 25 |
| 201525E | 10435..... | 03 | 202609 | 11307..... | 35 |
| 201528c | 11203..... | 04 | 202610 | 11305..... | 02 |
| 201531 | 11223..... | 03 | 202613 | 11213..... | 03 |
| 201537 | 11202..... | 03 | 202622 | 10438..... | 01 |
| 201557 | 11225..... | 15 | 202668 | 11306..... | 15 |
| 201563B | 11220..... | 10 | 202837 | 11218..... | 1 75 |
| 201566B | 11305..... | 05 | 202924 | 11218..... | 60 |
| 201569B | 10434..... | 35 | 202928 | | 75 |
| 201572B | 10493..... | 04 | 202932 | | 75 |
| 201600E | 11307..... | 20 | *202973 | | --- |
| 201816 | 11031..... | 12 | *202974 | | --- |
| 202005 | 10434..... | 01 | 202991 | 11203..... | 1 00 |
| 202015 | 10434..... | 05 | 203021 | 11203..... | 1 15 |
| 202016 | 10434..... | 05 | 203075 | 11519..... | 40 |
| 202027 | 11215..... | 01 | 203206 | 11003..... | 30 |
| 202036 | 10438..... | 01 | 203207 | 11003..... | 25 |
| *202056 | | 01 | 203208 | 11228..... | 05 |
| 202062 | 11203..... | 01 | 203209 | 11228..... | 25 |
| *202064 | 11005..... | 01 | 203210 | 11228..... | 55 |
| 202068 | 10710..... | 15 | *203211 | | 01 |
| 202075 | 10443..... | 03 | *203212 | | 02 |
| 202084 | 10444..... | 01 | *203213 | | 01 |
| 202090 | 10443..... | 01 | 203214 | 11228..... | 01 |

Numerical List of Parts

| No. | Plate | Each | No. | Plate | Each |
|---------|------------------|-------|---------|------------|-------|
| 203215 | 11228..... | 03 | 203341 | 11306..... | 50 |
| 203216 | 11228 per 100... | 25 | 203342 | 11306..... | 75 |
| 203217 | 11228..... | 80 | 203343 | 11204..... | 25 |
| 203233 | 11005..... | 50 | 203344 | 11307..... | 03 |
| 203235 | 11005..... | 75 | 203345 | 11307..... | 25 |
| 203238 | 11005..... | 35 | 203346 | 11301..... | 2 25 |
| *203239 | | --- | 203347 | 11307..... | 40 |
| 203240 | 11228..... | 2 20 | 203349 | 11307..... | 03 |
| 203241 | 11007..... | 85 | *203401 | | 8 00 |
| 203242 | 11007..... | 1 00 | 203403 | 11304..... | 80 |
| 203243 | 11304..... | 40 | 203404 | 11303..... | 85 |
| 203244 | 11007..... | 20 | 203405 | 11303..... | 50 |
| 203245 | 11007..... | 1 00 | 203407 | 11303..... | 75 |
| 203246 | 11007..... | 75 | 203412 | 11306..... | 75 |
| 203248 | 11301..... | 20 | 203462 | 11229..... | 10 50 |
| 203249 | 11007..... | 25 | 203703 | 14501..... | 1 00 |
| 203250 | 11007..... | 20 | 203704 | 14501..... | 1 25 |
| 203251 | 11228..... | 40 | 203705 | 14501..... | 1 50 |
| 203252 | 11227..... | 1 00 | 203935 | 11215..... | 02 |
| 203253 | 11227..... | 5 00 | 204058B | 10441..... | 01 |
| 203254 | 11228..... | 20 | 204059 | | 15 |
| *203255 | | 01 | 204163 | 10710..... | 10 |
| 203257 | 11010 per 100... | 25 | *204166 | | --- |
| 203268 | 11031..... | 1 50 | *204167 | | --- |
| 203270 | 11010..... | 60 | 204169B | | 1 00 |
| 203274 | 11010..... | 90 | 204170 | | 20 |
| 203290 | 11228..... | 3 00 | 204172 | | 1 70 |
| 203301 | 11003..... | 35 | 204184 | 11301..... | 75 |
| 203302 | 11301..... | 3 50 | 204185 | 10435..... | 03 |
| 203303 | 11032..... | 50 | 204186 | 11301..... | 2 40 |
| 203304 | 11032..... | 25 | 204188 | 10435..... | 03 |
| 203305 | 11301..... | 35 | 204189 | 10435..... | 01 |
| 203306 | 11304..... | 45 | 204192 | 10436..... | 70 |
| 203307 | 11229..... | 1 25 | 204193 | 11003..... | 35 |
| 203308 | 11229..... | 5 25 | 204194 | 10438..... | 45 |
| 203314 | 11032..... | 05 | 204195 | 10436..... | 15 |
| *203326 | | 10 00 | 204196 | 10436..... | 25 |
| 203327 | 11301..... | 2 00 | 204197 | 10436..... | 15 |
| *203328 | | 5 00 | 204198 | 11304..... | 1 30 |
| 203330 | 11303..... | 85 | 204200 | 10435..... | 35 |
| 203331 | 11305..... | 35 | 204202 | 11303..... | 75 |
| 203332 | 11305..... | 1 25 | 204206 | 11003..... | 10 |
| 203333 | 11305..... | 15 | 204207 | 11003..... | 55 |
| 203334 | 11305..... | 75 | 204208 | 10438..... | 05 |
| 203335 | 11305..... | 05 | 204209 | 10438..... | 01 |
| 203336 | 11306..... | 1 10 | 204210 | 10438..... | 20 |
| 203337 | 11304..... | 1 25 | 204211 | 10438..... | 20 |
| 203338 | 11306..... | 15 | 204212 | 10438..... | 15 |
| 203339 | 11306..... | 02 | 204213 | 10438..... | 15 |
| *203340 | 11202..... | 25 | 204214 | | 95 |

Numerical List of Parts

| No. | Plate | Each | No. | Plate | Each |
|--------|-------|------|--------|-------|------|
| 204248 | 11010 | 35 | 211008 | 11355 | 1 50 |
| 204249 | 11010 | 40 | 211009 | 11355 | 1 25 |
| 204250 | 11010 | 03 | 211010 | 11355 | 60 |
| 204251 | 11304 | 80 | 211011 | 11358 | 1 25 |
| 204252 | 10441 | 20 | 211012 | 11356 | 1 25 |
| 204253 | 10441 | 40 | 211013 | 11356 | 1 25 |
| 204254 | 10441 | 30 | 211014 | 11356 | 75 |
| 204255 | 10441 | 10 | 211015 | 11357 | 1 50 |
| 204263 | 11031 | 15 | 211016 | 11357 | 1 50 |
| 204264 | 11031 | 01 | 211017 | 11357 | 85 |
| 204265 | 11031 | 05 | 211019 | 11354 | 1 25 |
| 204267 | 10443 | 05 | 211020 | 11354 | 75 |
| 204268 | 10443 | 10 | 211021 | 11354 | 1 25 |
| 204269 | 10443 | 02 | 211022 | 11354 | 75 |
| 204271 | 10443 | 05 | 211025 | 11356 | 1 25 |
| 204272 | 10443 | 50 | 211026 | 11356 | 1 25 |
| 204273 | 10444 | 15 | 211027 | 11356 | 75 |
| 204274 | 10444 | 12 | 211028 | 11356 | 1 25 |
| 204275 | 10444 | 10 | 211029 | 11356 | 1 25 |
| 204276 | 10444 | 03 | 211030 | 11356 | 75 |
| 204277 | 10444 | 15 | 211031 | 11356 | 1 25 |
| 204278 | 10444 | 10 | 211032 | 11356 | 1 25 |
| 204279 | 10444 | 10 | 211033 | 11357 | 1 50 |
| 204280 | 10444 | 45 | 211034 | 11357 | 1 50 |
| 204281 | 10444 | 01 | 211035 | 11357 | 85 |
| 204293 | 10436 | 01 | 211039 | 11358 | 3 00 |
| 204294 | 11301 | 35 | 211040 | 11358 | 3 00 |
| 204296 | 10710 | 10 | 211041 | 11358 | 85 |
| 204297 | — | 25 | 211044 | 11356 | 75 |
| 204333 | 10444 | 08 | 211045 | 11354 | 75 |
| 204533 | 11301 | 1 10 | 211891 | 11549 | 1 50 |
| 204551 | — | 15 | 211895 | 11549 | 1 50 |
| 204552 | 11301 | 75 | 213624 | 11301 | 1 75 |
| 204553 | — | 75 | 225585 | 11007 | 02 |
| 204554 | 11103 | 1 05 | 225586 | 11221 | 01 |
| 204555 | 11032 | 10 | 225708 | 11226 | 10 |
| 204801 | — | 35 | 225735 | 11220 | 40 |
| 204802 | — | 35 | 225744 | 11225 | 15 |
| 204804 | 11301 | 80 | 225847 | — | 1 25 |
| 204805 | 11301 | 1 00 | 225856 | 11210 | 25 |
| 204827 | 11304 | 80 | 225925 | 11220 | 05 |
| 204925 | 11307 | 01 | 226110 | 11220 | 40 |
| 206042 | 11202 | 03 | 226322 | 11510 | 1 50 |
| 211001 | 11350 | 1 00 | 226323 | 11510 | 2 00 |
| 211002 | 11350 | 60 | 226324 | 11510 | 1 00 |
| 211003 | 11350 | 1 00 | 226325 | 11510 | 4 50 |
| 211004 | 11350 | 1 00 | 226326 | 11219 | 2 50 |
| 211005 | 11350 | 1 00 | 226327 | 11203 | 50 |
| 211006 | 11350 | 75 | 226328 | 11203 | 10 |
| 211007 | 11350 | 85 | 226329 | 11202 | 35 |

Numerical List of Parts

| No. | Plate | Each | No. | Plate | Each |
|--------|-------|-------|---------|-------|-------|
| 226330 | 11202 | 05 | 226386 | — | 4 00 |
| 226331 | 11202 | 2 00 | 226387 | 11210 | 4 75 |
| 226332 | 11216 | 2 50 | 226388 | 11209 | 5 00 |
| 226334 | 11202 | 25 | 226389 | 11209 | 1 50 |
| 226335 | 11201 | 75 | 226390 | — | 6 50 |
| 226336 | 11204 | 25 | 226391 | 11210 | 25 |
| 226337 | 11204 | 15 | 226392 | — | 8 50 |
| 226338 | 11204 | 02 | 226393 | 11214 | 1 25 |
| 226339 | 11202 | 1 75 | 226394 | 11214 | 2 15 |
| 226340 | 11202 | 70 | 226395 | 11214 | 1 25 |
| 226341 | 11223 | 25 | 226396 | 11211 | 3 35 |
| 226345 | 11211 | 1 60 | 226397 | 11213 | 85 |
| 226346 | 11211 | 3 75 | 226398 | 11213 | 01 |
| 226347 | 11203 | 50 | 226399 | 11213 | 05 |
| 226348 | 11206 | 60 | 226400 | 11212 | 2 00 |
| 226349 | 11203 | 25 | 226402 | 11213 | 2 50 |
| 226350 | 11201 | 75 | *226403 | — | 25 |
| 226351 | 11201 | 75 | 226404 | 11213 | 50 |
| 226352 | 11203 | 05 | 226405 | 11213 | 1 00 |
| 226353 | 11211 | 35 | 226406 | 11211 | 2 25 |
| 226354 | 11211 | 1 00 | 226407 | 11215 | 1 25 |
| 226355 | 11211 | 30 | 226408 | 11211 | 4 00 |
| 226356 | 11204 | 25 | 226409 | 11213 | 35 |
| 226357 | — | 4 75 | 226410 | 11211 | 1 60 |
| 226359 | 11201 | 1 00 | 226411 | 11211 | 3 00 |
| 226360 | 11211 | 3 75 | 226413 | 11215 | 50 |
| 226361 | 11205 | 4 00 | 226414 | — | 14 00 |
| 226362 | — | 16 00 | 226415 | 11216 | 1 85 |
| 226363 | — | 14 00 | 226416 | 11217 | 60 |
| 226364 | 11208 | 2 25 | 226418 | 11217 | 1 25 |
| 226365 | 11205 | 2 00 | 226419 | 11217 | 75 |
| 226366 | 11209 | 35 | 226420 | 11201 | 4 00 |
| 226367 | 11208 | 75 | 226421 | 11217 | 1 50 |
| 226368 | 11205 | 3 00 | 226422 | 11215 | 1 00 |
| 226369 | — | 4 50 | 226423 | 11215 | 60 |
| 226370 | 11206 | 1 75 | 226424 | 11212 | 1 60 |
| 226371 | 11208 | 1 00 | 226426 | 11218 | 1 00 |
| 226372 | 11206 | 2 50 | 226427 | 11218 | 35 |
| 226373 | 11208 | 50 | 226429 | 11211 | 4 75 |
| 226374 | 11208 | 1 00 | 226430 | — | 16 50 |
| 226375 | — | 1 75 | 226431 | — | 4 00 |
| 226376 | 11208 | 25 | 226432 | 11214 | 1 25 |
| 226377 | — | 4 00 | 226433 | 11211 | 3 35 |
| 226378 | 11210 | 75 | 226434 | 11218 | 1 00 |
| 226379 | 11207 | 2 00 | 226435 | 11224 | 1 00 |
| 226380 | — | 3 00 | 226437 | 11218 | 1 75 |
| 226382 | 11210 | 25 | 226438 | 11218 | 1 50 |
| 226383 | 11210 | 1 00 | 226439 | 11221 | 35 |
| 226384 | 11210 | 1 00 | 226440 | 11221 | 50 |
| 226385 | 11207 | 1 25 | 226441 | 11219 | 75 |

| No. | Plate | Each | No. | Plate | Each |
|--------|-------|-------|--------|-------|-------|
| 226442 | 11221 | 25 | 226496 | 11500 | 25 |
| 226443 | — | 10 00 | 226497 | 11500 | 75 |
| 226444 | 11222 | 1 00 | 226498 | 11500 | 50 |
| 226445 | — | 1 75 | 226499 | 11505 | 35 |
| 226446 | 11222 | 4 50 | 226500 | — | 5 00 |
| 226448 | 11221 | 15 | 226501 | 11501 | 2 50 |
| 226449 | 11214 | 25 | 226502 | 11501 | 1 75 |
| 226450 | 11221 | 25 | 226503 | 11501 | 1 25 |
| 226451 | 11214 | 1 00 | 226504 | 11501 | 2 50 |
| 226452 | 11222 | 1 65 | 226505 | 11502 | 1 50 |
| 226453 | 11222 | 12 00 | 226506 | 11502 | 50 |
| 226454 | 11222 | 75 | 226507 | 11502 | 25 |
| 226455 | 11221 | 05 | 226508 | — | 5 00 |
| 226456 | 11223 | 1 00 | 226509 | 11503 | 3 00 |
| 226457 | 11223 | 35 | 226510 | 11503 | 2 00 |
| 226458 | 11223 | 1 25 | 226511 | 11503 | 3 00 |
| 226460 | — | 4 75 | 226512 | 11503 | 75 |
| 226461 | — | 24 00 | 226513 | 11502 | 75 |
| 226463 | 11223 | 1 00 | 226514 | 11502 | 25 |
| 226464 | 11223 | 1 50 | 226515 | 11503 | 50 |
| 226465 | 11224 | 2 50 | 226516 | — | 13 50 |
| 226466 | 11512 | 25 | 226517 | 11504 | 5 00 |
| 226467 | 11223 | 05 | 226518 | 11504 | 3 50 |
| 226468 | 11223 | 50 | 226519 | 11504 | 25 |
| 226469 | 11225 | 60 | 226520 | 11504 | 1 00 |
| 226471 | 11225 | 75 | 226521 | 11504 | 50 |
| 226472 | 11225 | 2 25 | 226522 | 11504 | 3 |
| 226473 | 11224 | 3 50 | 226523 | — | 5 50 |
| 226474 | 11226 | 1 00 | 226524 | 11503 | 1 50 |
| 226475 | 11219 | 2 50 | 226525 | 11503 | 50 |
| 226476 | 11226 | 1 50 | 226526 | 11503 | 1 |
| 226477 | 11226 | 35 | 226527 | 11503 | 01 |
| 226478 | — | 18 50 | 226528 | — | 5 5 |
| 226479 | 11226 | 1 50 | 226529 | 11505 | 3 5 |
| 226480 | 11226 | 35 | 226530 | 11207 | 6 7 |
| 226481 | 11226 | 2 00 | 226531 | 11505 | 2 0 |
| 226482 | 11216 | 2 50 | 226532 | 11505 | 7 |
| 226483 | 11211 | 1 00 | 226533 | 11505 | 5 |
| 226484 | — | 3 50 | 226535 | 11505 | 5 |
| 226485 | 11226 | 25 | 226536 | — | 4 5 |
| 226486 | 11212 | 75 | 226537 | 11506 | 2 0 |
| 226487 | 11212 | 60 | 226538 | 11506 | 1 5 |
| 226488 | 11212 | 1 60 | 226539 | 11506 | 1 0 |
| 226489 | 11211 | 3 00 | 226540 | 11507 | 7 |
| 226490 | — | 4 00 | 226541 | 11507 | 2 0 |
| 226491 | 11204 | 05 | 226542 | 11507 | 2 5 |
| 226492 | 11212 | 65 | 226543 | 11507 | 5 |
| 226493 | — | 18 50 | 226544 | 11507 | 5 |
| 226494 | 11500 | 2 50 | 226545 | — | 5 5 |
| 226495 | 11500 | 3 75 | 226546 | — | 12 0 |

| No. | Plate | Each | No. | Plate | Each |
|--------|-------|-------|--------|-------|-------|
| 226517 | 11508 | 1 75 | 226597 | 11517 | 75 |
| 226518 | 11508 | 1 50 | 226598 | 11516 | 3 75 |
| 226519 | 11508 | 2 00 | 226599 | — | 18 50 |
| 226550 | 11508 | 25 | 226600 | 11517 | 1 50 |
| 226551 | — | 11 00 | 226601 | 11517 | 2 50 |
| 226552 | 11509 | 2 50 | 226602 | 11518 | 4 00 |
| 226553 | 11509 | 50 | 226603 | — | 15 00 |
| 226554 | 11509 | 50 | 226604 | 11518 | 1 50 |
| 226555 | 11509 | 2 50 | 226605 | 11518 | 2 00 |
| 226556 | 11509 | 35 | 226606 | 11519 | 1 00 |
| 226557 | — | 12 00 | 226607 | 11519 | 4 50 |
| 226558 | 11211 | 1 60 | 226608 | 11515 | 25 |
| 226559 | 11511 | 1 75 | 226609 | 11520 | 2 50 |
| 226560 | 11511 | 75 | 226610 | 11520 | 1 50 |
| 226561 | 11511 | 1 00 | 226611 | 11520 | 50 |
| 226562 | 11224 | 3 75 | 226612 | 11520 | 25 |
| 226563 | 11511 | 60 | 226613 | 11520 | 25 |
| 226564 | 11224 | 1 60 | 226614 | 11521 | 75 |
| 226565 | — | 1 25 | 226615 | 11211 | 25 |
| 226566 | 11512 | 25 | 226616 | — | 50 |
| 226567 | 11512 | 2 25 | 226617 | 11519 | 25 |
| 226568 | 11512 | 50 | 226618 | 11516 | 00 |
| 226569 | — | 19 00 | 226619 | 11521 | 00 |
| 226570 | 11512 | 2 00 | 226620 | — | 00 |
| 226571 | 11512 | 3 00 | 226621 | 11521 | 35 |
| 226572 | 11513 | 1 50 | 226622 | 11521 | 75 |
| 226573 | 11513 | 2 50 | 226623 | — | 00 |
| 226574 | 11513 | 4 00 | 226624 | 11506 | 25 |
| 226575 | 11513 | 50 | 226625 | 11522 | 75 |
| 226576 | 11513 | 50 | 226626 | 11523 | 50 |
| 226577 | 11513 | 50 | 226627 | 11523 | 75 |
| 226578 | — | 10 00 | 226628 | 11523 | 00 |
| 226579 | 11514 | 4 00 | 226629 | 11524 | 25 |
| 226580 | 11514 | 3 00 | 226630 | 11524 | 1 75 |
| 226581 | 11514 | 75 | 226631 | — | 13 50 |
| 226582 | 11514 | 10 | 226632 | — | 4 50 |
| 226583 | — | — | 226633 | 11524 | 2 25 |
| 226584 | — | — | 226634 | 11524 | 50 |
| 226585 | 11514 | 2 25 | 226635 | 11524 | 75 |
| 226586 | 11514 | 50 | 226636 | — | 4 00 |
| 226587 | — | 15 00 | 226637 | 11525 | 1 25 |
| 226588 | 11515 | 2 50 | 226638 | 11525 | 75 |
| 226589 | 11516 | 2 00 | 226639 | 11525 | 50 |
| 226590 | — | 16 00 | 226640 | 11525 | 50 |
| 226591 | 11516 | 1 35 | 226641 | 11525 | 50 |
| 226592 | 11516 | 3 50 | 226642 | 11526 | 4 50 |
| 226593 | 11515 | 2 75 | 226643 | 11526 | 1 25 |
| 226594 | 11516 | 2 00 | 226644 | 11526 | 2 00 |
| 226595 | 11515 | 50 | 226645 | 11526 | 3 25 |
| 226596 | — | 14 00 | 226646 | — | 8 00 |

Numerical List of Parts

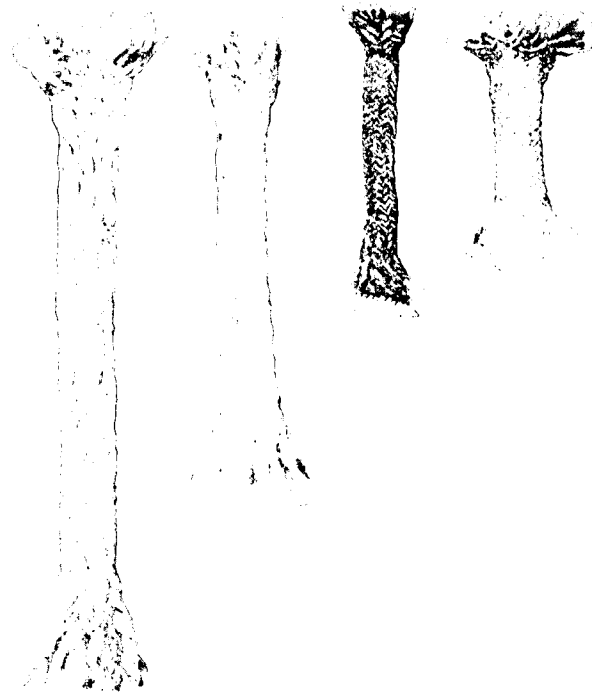
| No. | Plate | Each | No. | Plate | Each |
|--------|------------|-------|--------|------------|-------|
| 226647 | 11527..... | 4 00 | 226697 | 11522..... | 2 00 |
| 226648 | 11527..... | 2 00 | 226698 | ----- | 20 00 |
| 226649 | 11527..... | 50 | 226699 | 11535..... | 2 50 |
| 226650 | 11527..... | 25 | 226700 | 11535..... | 7 1 |
| 226651 | 11527..... | 50 | 226701 | 11536..... | 3 50 |
| 226652 | 11527..... | 6 00 | 226702 | ----- | 11 50 |
| 226653 | 11528..... | 15 00 | 226703 | 11537..... | 2 00 |
| 226654 | 11528..... | 1 25 | 226704 | 11537..... | 50 |
| 226655 | ----- | 20 00 | 226705 | 11537..... | 50 |
| 226656 | 11529..... | 5 00 | 226706 | 11537..... | 50 |
| 226657 | 11528..... | 2 50 | 226707 | 11538..... | 3 0 |
| 226658 | 11529..... | 7 50 | 226708 | 11537..... | 1 0 |
| 226659 | 11524..... | 50 | 226709 | ----- | 11 0 |
| 226660 | 11528..... | 1 50 | 226710 | 11538..... | 1 0 |
| 226661 | ----- | 13 00 | 226711 | 11522..... | 1 6 |
| 226662 | 11530..... | 3 00 | 226712 | ----- | 2 9 |
| 226663 | 11530..... | 05 | 226713 | 11538..... | 3 5 |
| 226664 | 11519..... | 60 | 226714 | ----- | 20 0 |
| 226665 | 11522..... | 3 60 | 226715 | 11535..... | 7 |
| 226666 | 11530..... | 25 | 226717 | 11539..... | 7 |
| 226667 | 11530..... | 50 | 226718 | 11539..... | 1 5 |
| 226668 | ----- | 2 25 | 226719 | ----- | 9 0 |
| 226669 | 11530..... | 3 00 | 226720 | 11540..... | 3 0 |
| 226670 | ----- | 7 50 | 226721 | 11540..... | 3 |
| 226671 | 11531..... | 2 00 | 226722 | 11540..... | 5 |
| 226672 | 11531..... | 1 00 | 226723 | 11540..... | 3 7 |
| 226673 | 11531..... | 25 | 226724 | 11532..... | 1 0 |
| 226674 | 11531..... | 1 00 | 226725 | ----- | 10 5 |
| 226675 | 11531..... | 4 00 | 226726 | 11540..... | 5 |
| 226676 | 11532..... | 50 | 226727 | 11541..... | 1 7 |
| 226677 | ----- | 8 50 | 226728 | 11541..... | 7 |
| 226678 | 11532..... | 3 00 | 226729 | 11536..... | 4 0 |
| 226679 | 11532..... | 2 00 | 226730 | 11541..... | 2 7 |
| 226680 | 11533..... | 4 75 | 226731 | 11541..... | 7 |
| 226681 | 11522..... | 1 25 | 226732 | 11541..... | 7 |
| 226682 | ----- | 16 00 | 226733 | 11536..... | 10 0 |
| 226683 | 11533..... | 1 25 | 226734 | ----- | 16 4 |
| 226684 | 11533..... | 3 00 | 226735 | 11542..... | 1 0 |
| 226685 | 11533..... | 1 50 | 226736 | 11522..... | 1 0 |
| 226686 | 11529..... | 50 | 226737 | ----- | 19 0 |
| 226687 | 11532..... | 50 | 226738 | 11542..... | 7 |
| 226688 | 11534..... | 1 75 | 226739 | 11543..... | 1 7 |
| 226689 | ----- | 2 50 | 226740 | 11542..... | 7 |
| 226690 | 11534..... | 3 25 | 226741 | 11544..... | 1 0 |
| 226691 | 11535..... | 4 50 | 226742 | 11544..... | 2 0 |
| 226692 | ----- | 13 00 | 226743 | 11539..... | 7 |
| 226693 | 11536..... | 2 00 | 226744 | ----- | 2 0 |
| 226694 | 11534..... | 25 | 226745 | 11544..... | 2 7 |
| 226695 | 11534..... | 60 | 226746 | ----- | 10 0 |
| 226696 | 11536..... | 3 00 | 226747 | 11542..... | 3 7 |

Numerical List of Parts

| No. | Plate | Each | No. | Plate | Each |
|--------|------------|-------|--------|------------|-------|
| 226748 | 11545..... | 1 75 | 226771 | 11548..... | 3 00 |
| 226749 | 11545..... | 50 | 226772 | ----- | 21 75 |
| 226750 | 11545..... | 4 50 | 226773 | 11543..... | 3 50 |
| 226751 | ----- | 14 00 | 226774 | 11543..... | 2 00 |
| 226752 | ----- | 1 25 | 226775 | 11543..... | 50 |
| 226753 | 11545..... | 2 25 | 226776 | 11543..... | 5 50 |
| 226754 | ----- | 2 25 | 226777 | 11547..... | 35 |
| 226755 | 11544..... | 3 00 | 226778 | 11548..... | 25 |
| 226756 | ----- | 20 00 | 226779 | 11536..... | 3 00 |
| 226757 | 11546..... | 4 00 | 226780 | ----- | 16 00 |
| 226758 | 11546..... | 2 00 | 226781 | 11548..... | 2 50 |
| 226759 | 11546..... | 50 | 226782 | 11516..... | 2 00 |
| 226760 | 11528..... | 50 | 226784 | ----- | 14 00 |
| 226761 | 11546..... | 6 00 | 226785 | 11222..... | 12 00 |
| 226762 | 11547..... | 2 50 | 226786 | 11549..... | 35 |
| 226763 | 11547..... | 15 00 | 226787 | 11549..... | 50 |
| 226764 | 11546..... | 50 | 226788 | ----- | 15 00 |
| 226765 | ----- | 21 00 | 226789 | ----- | 00 |
| 226766 | 11543..... | 2 00 | 226790 | ----- | 24 00 |
| 226767 | 11547..... | 75 | 226791 | ----- | 4 25 |
| 226768 | 11543..... | 3 50 | 226792 | ----- | 35 |
| 226769 | 11545..... | 1 50 | 226793 | ----- | 16 00 |
| 226770 | 11548..... | 35 | 228032 | 11213..... | 01 |

PLATE 10279-FULL SIZE

202244 202260 202423 202254



202330 202277 202299



From the library of: Diamond Needle Corp

PLATE 10434-FULL SIZE

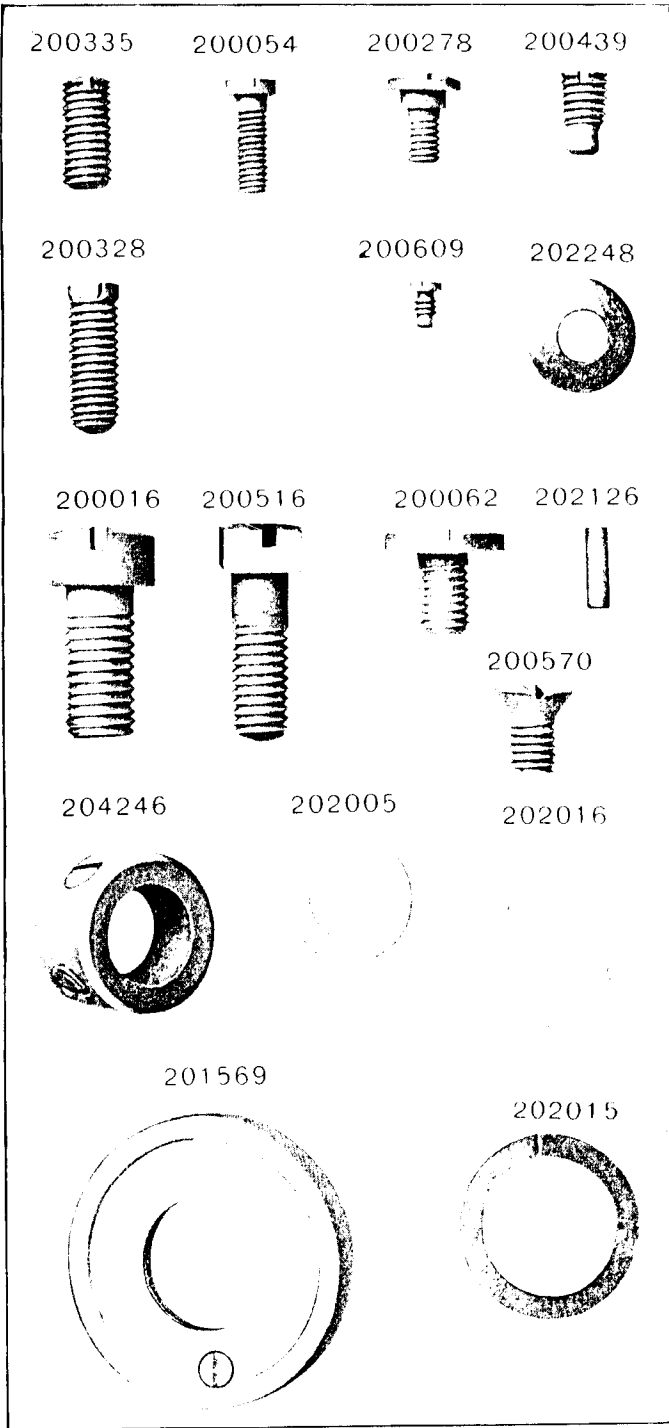


PLATE 10435-FULL SIZE

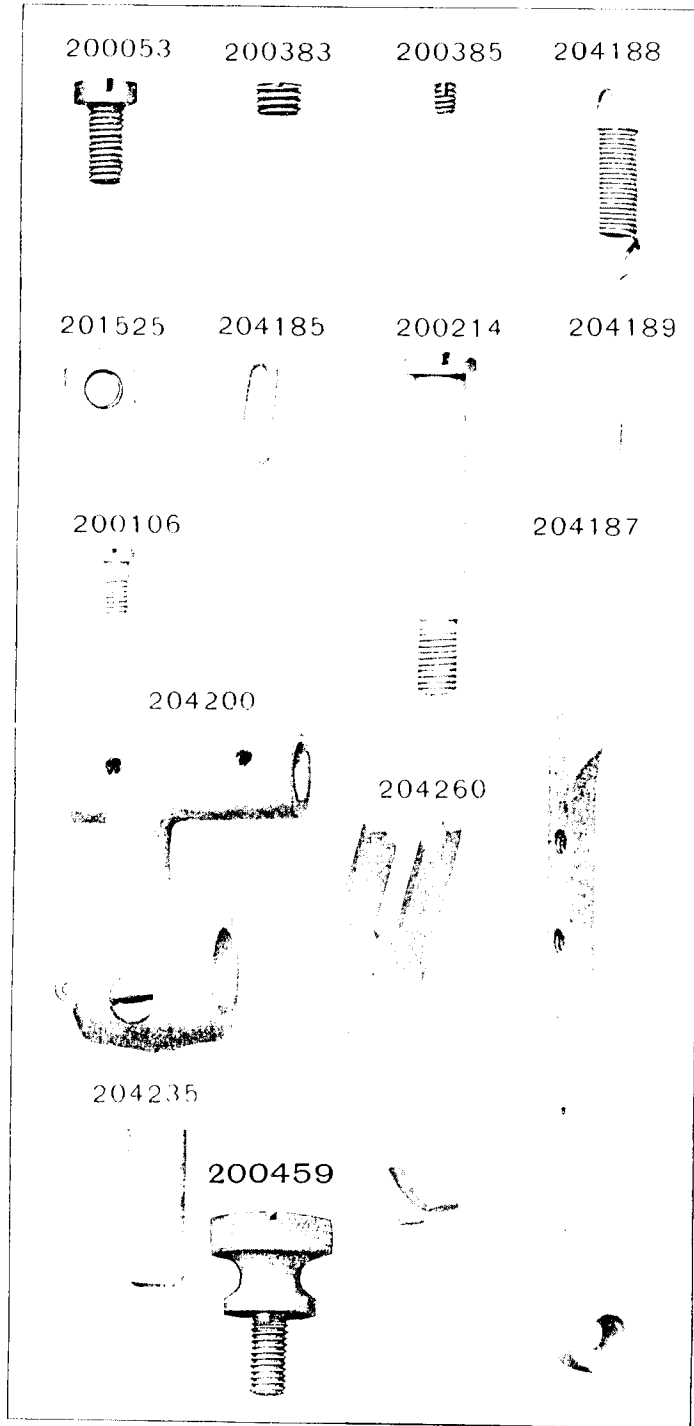


PLATE 10436—FULL SIZE

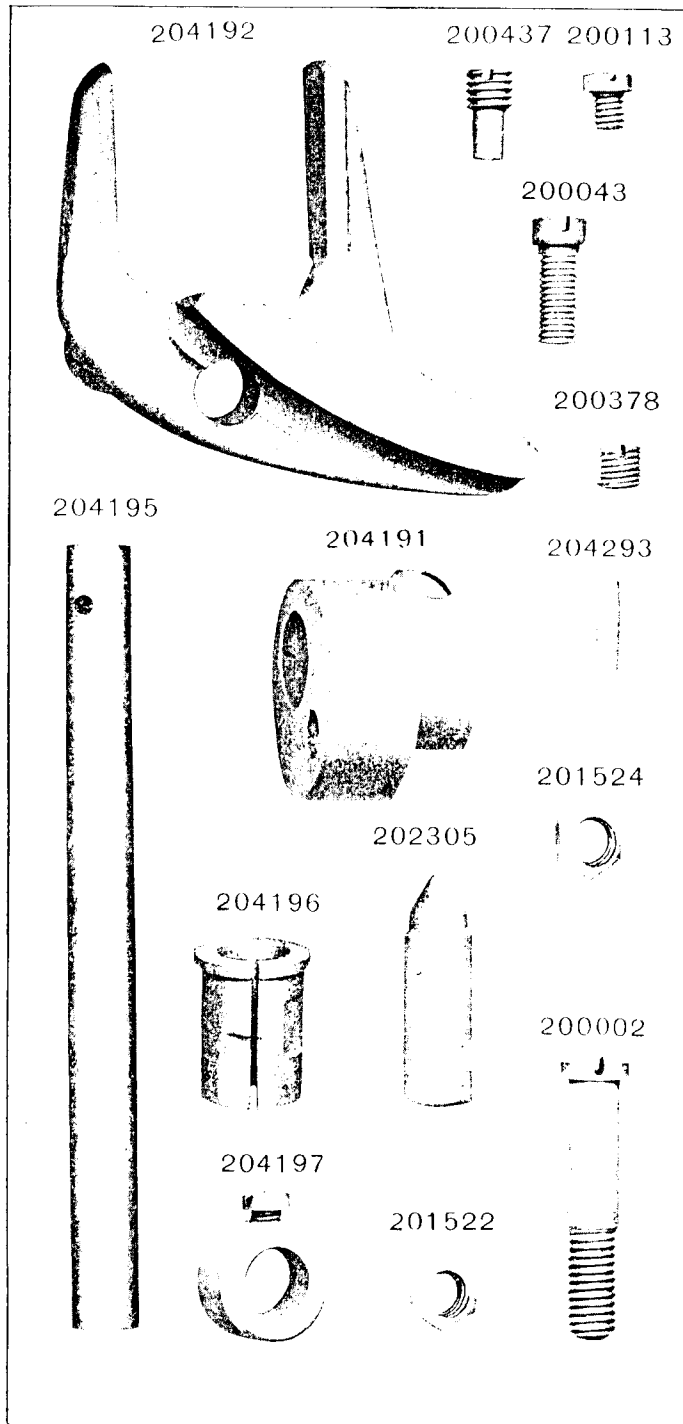
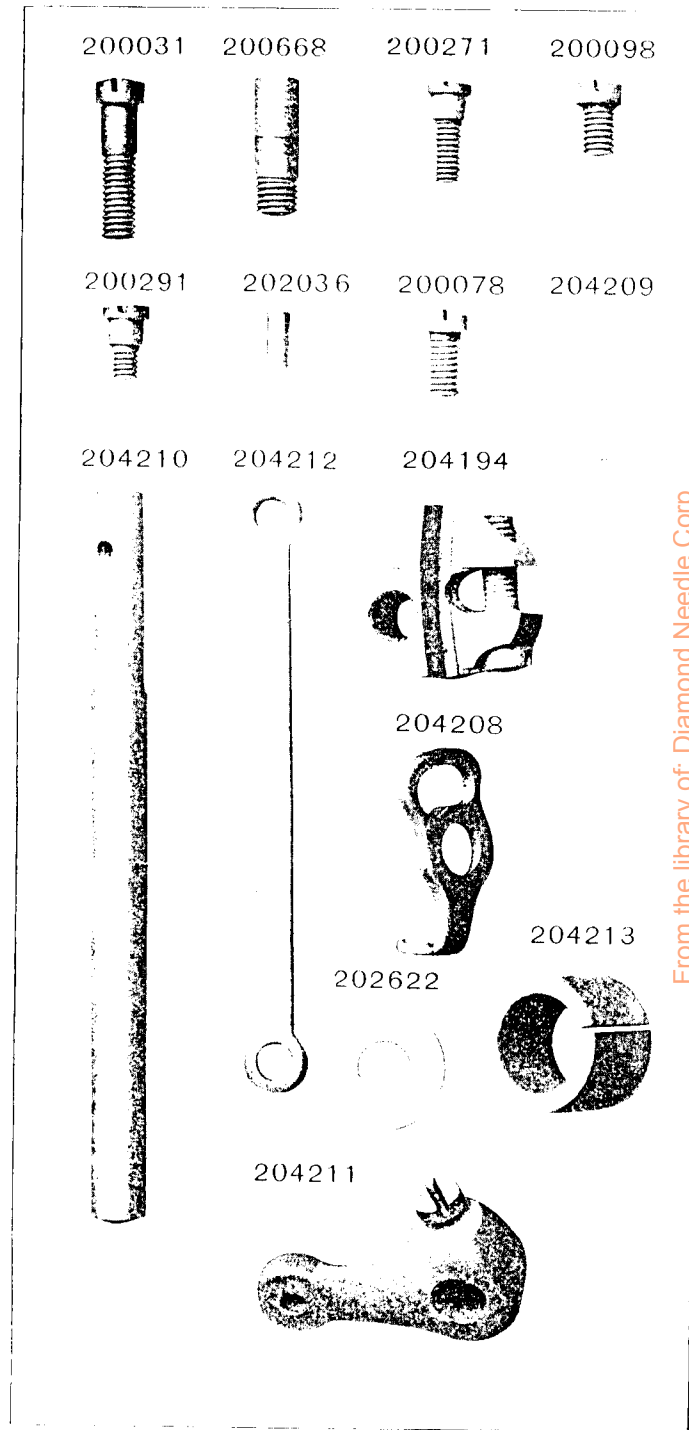


PLATE 10438—FULL SIZE



From the library of: Diamond Needle Corp

PLATE 10441-FULL SIZE

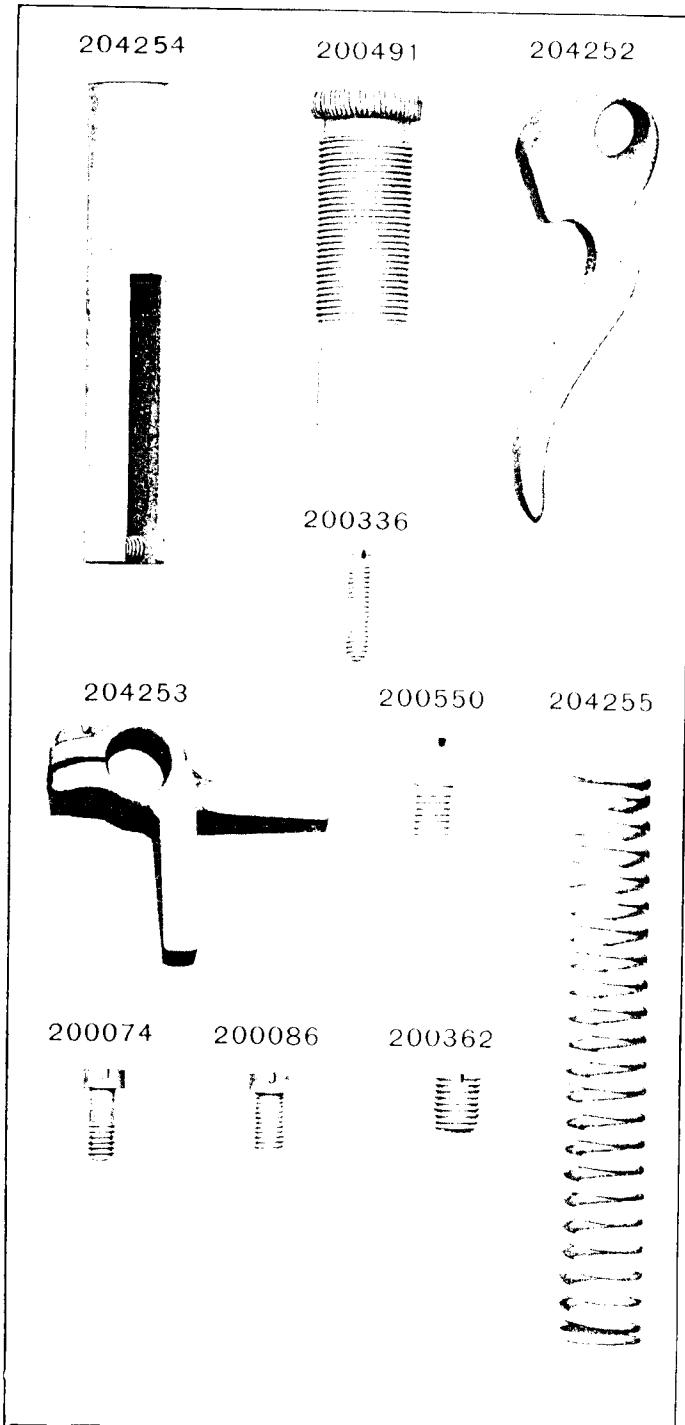
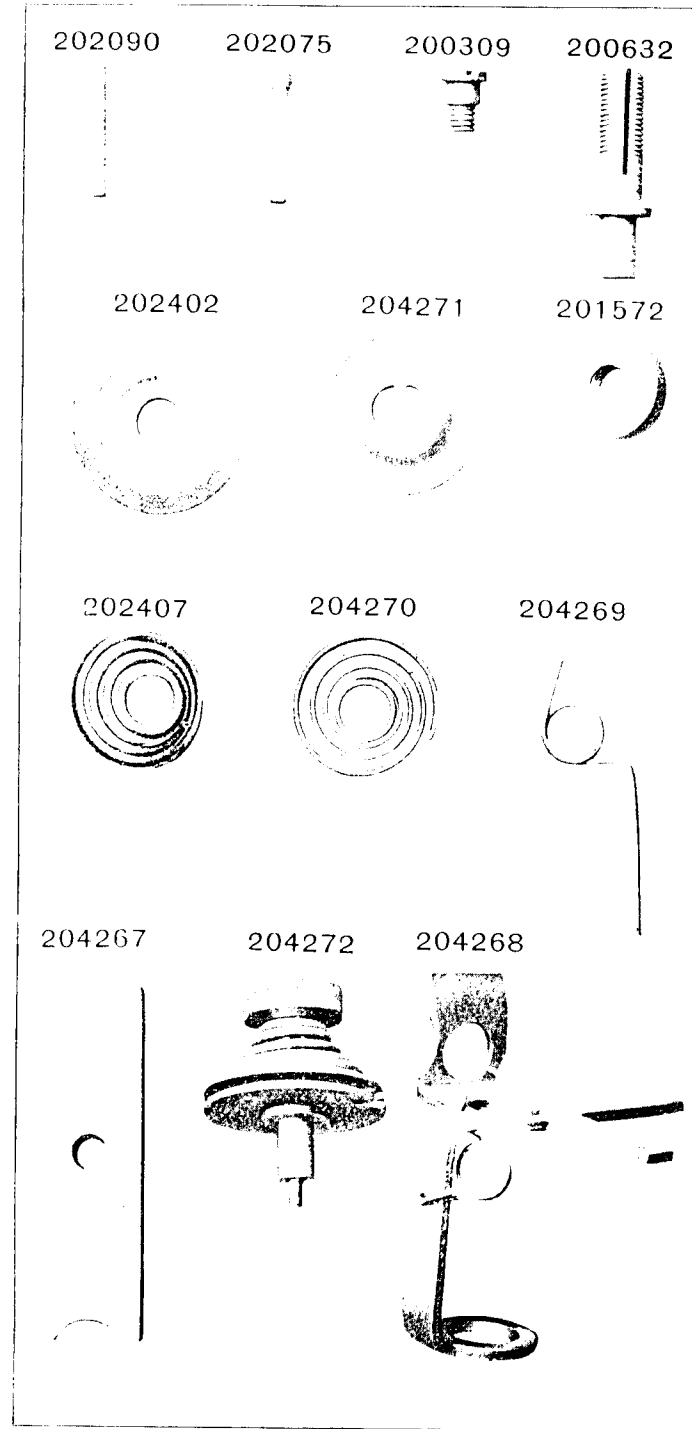


PLATE 10443-FULL SIZE



From the library of: Diamond Needle Corp

PLATE 10444—FULL SIZE

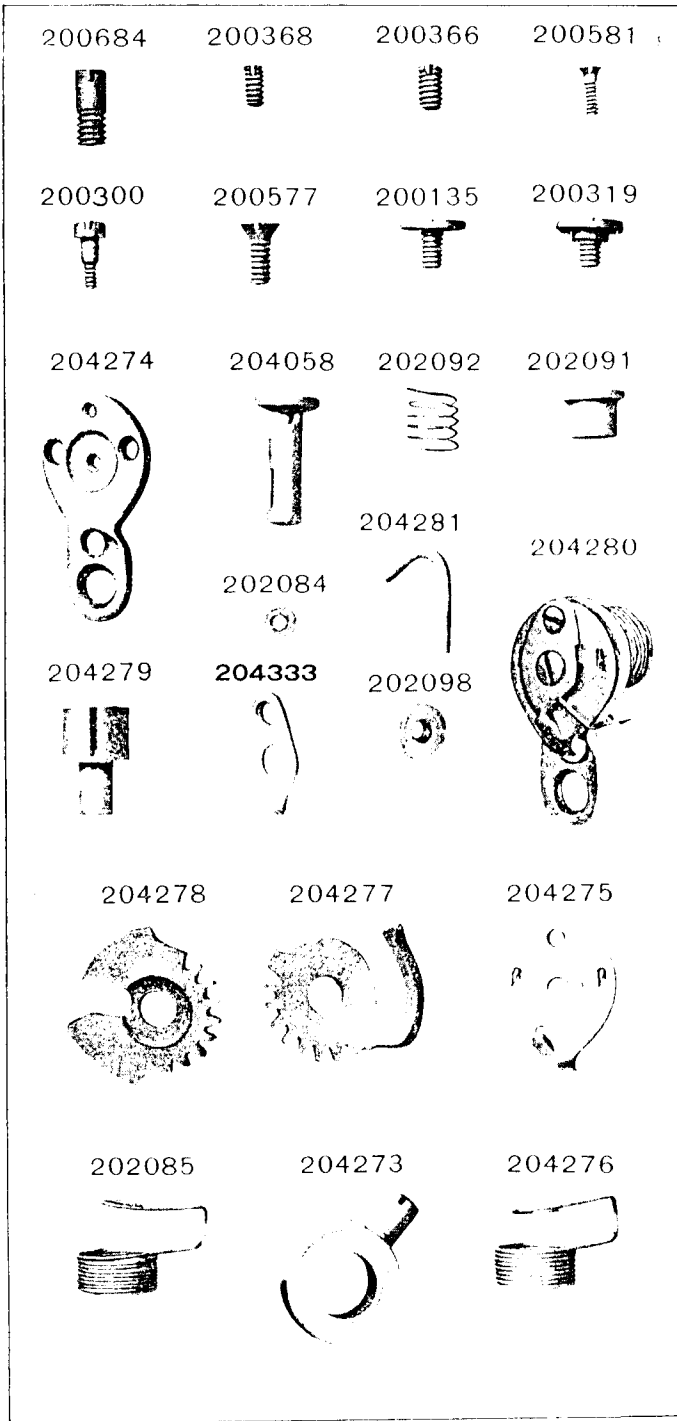


PLATE 10493—FULL SIZE

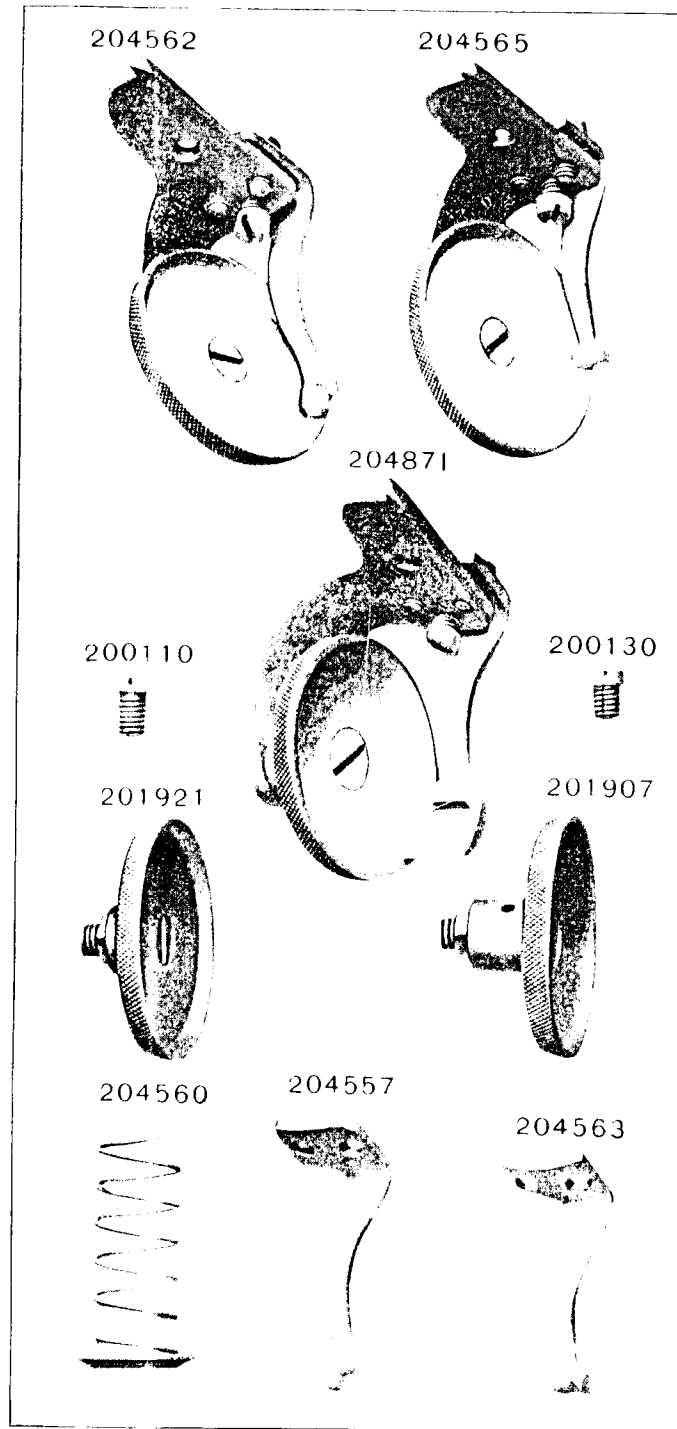


PLATE 10710—FULL SIZE

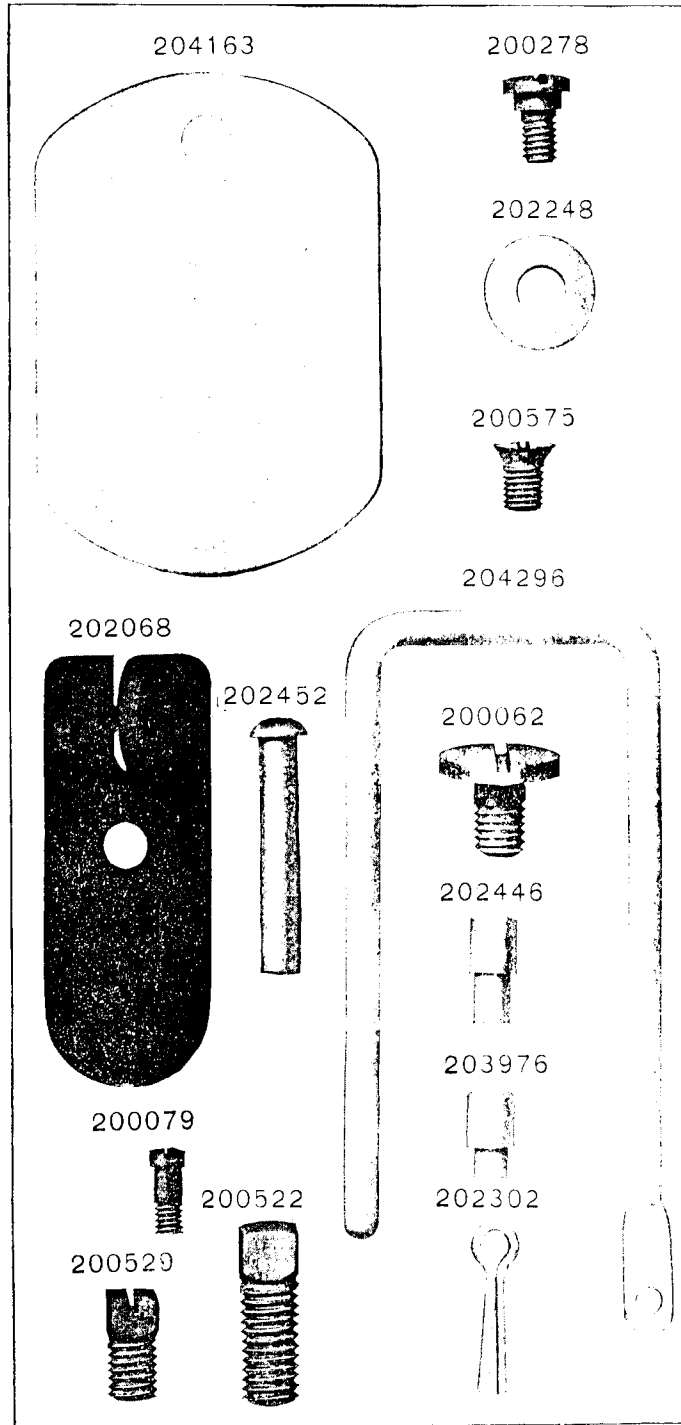


PLATE 11003—ONE-HALF SIZE

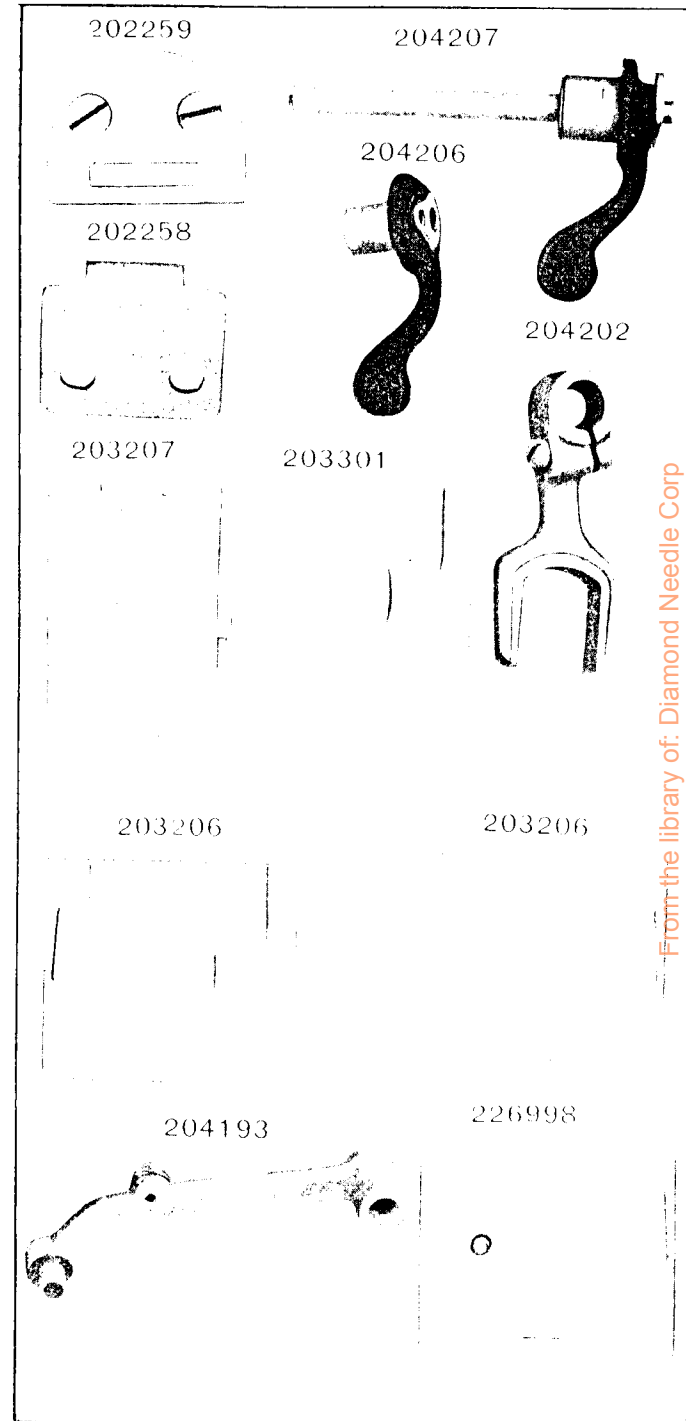


PLATE 11005—FULL SIZE

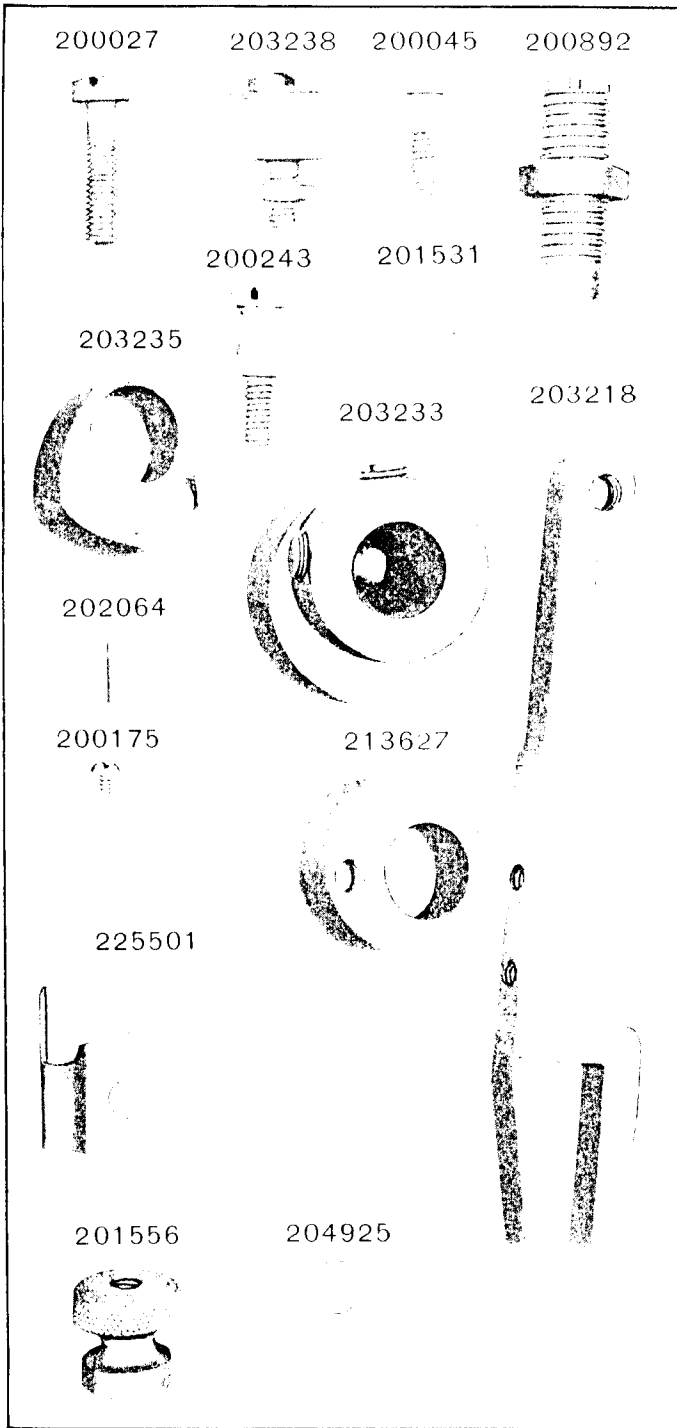
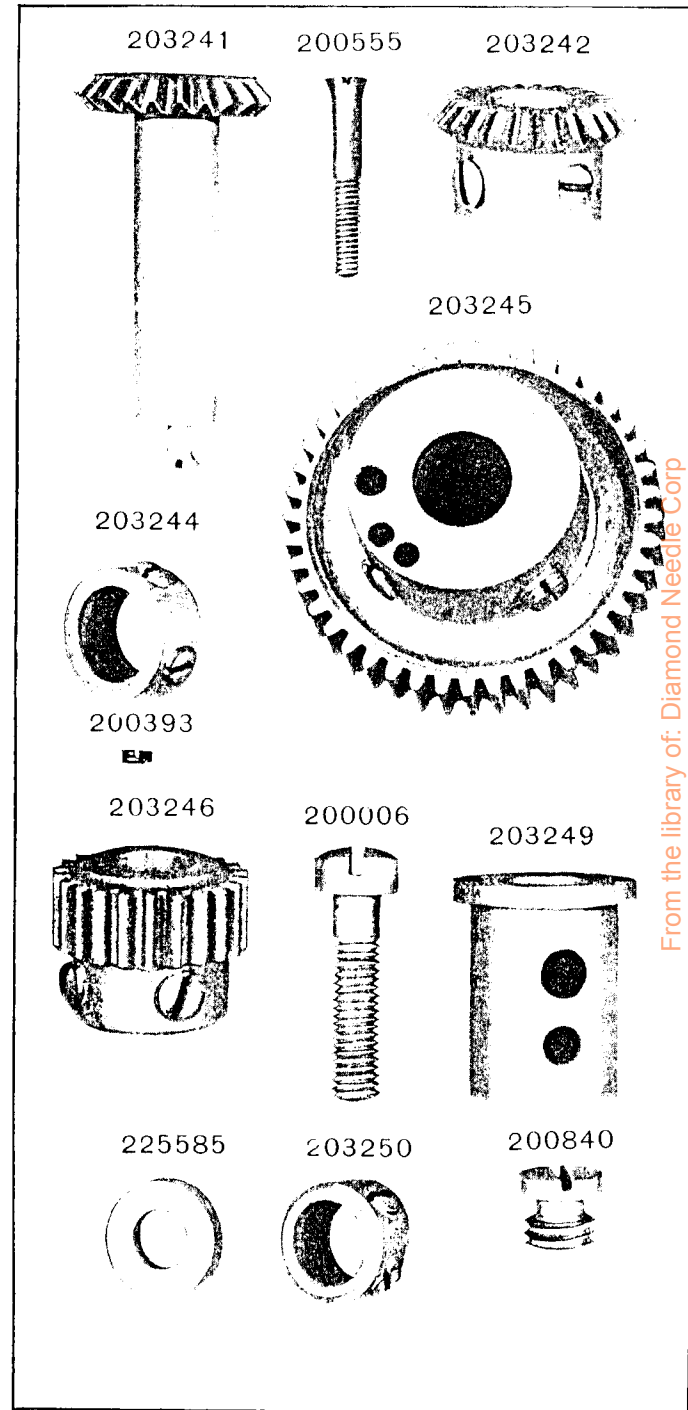


PLATE 11007—FULL SIZE



From the library of: Diamond Needle Corp

PLATE 11010—FULL SIZE

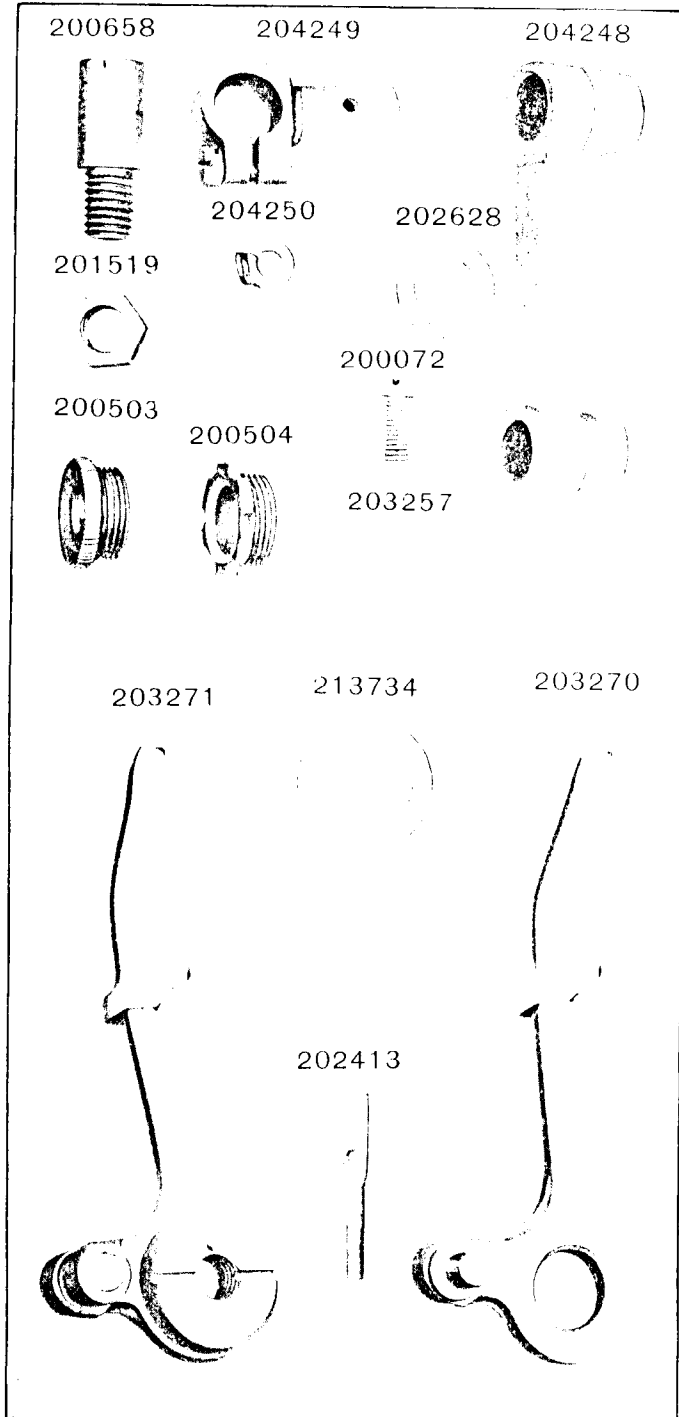


PLATE 11031—FULL SIZE

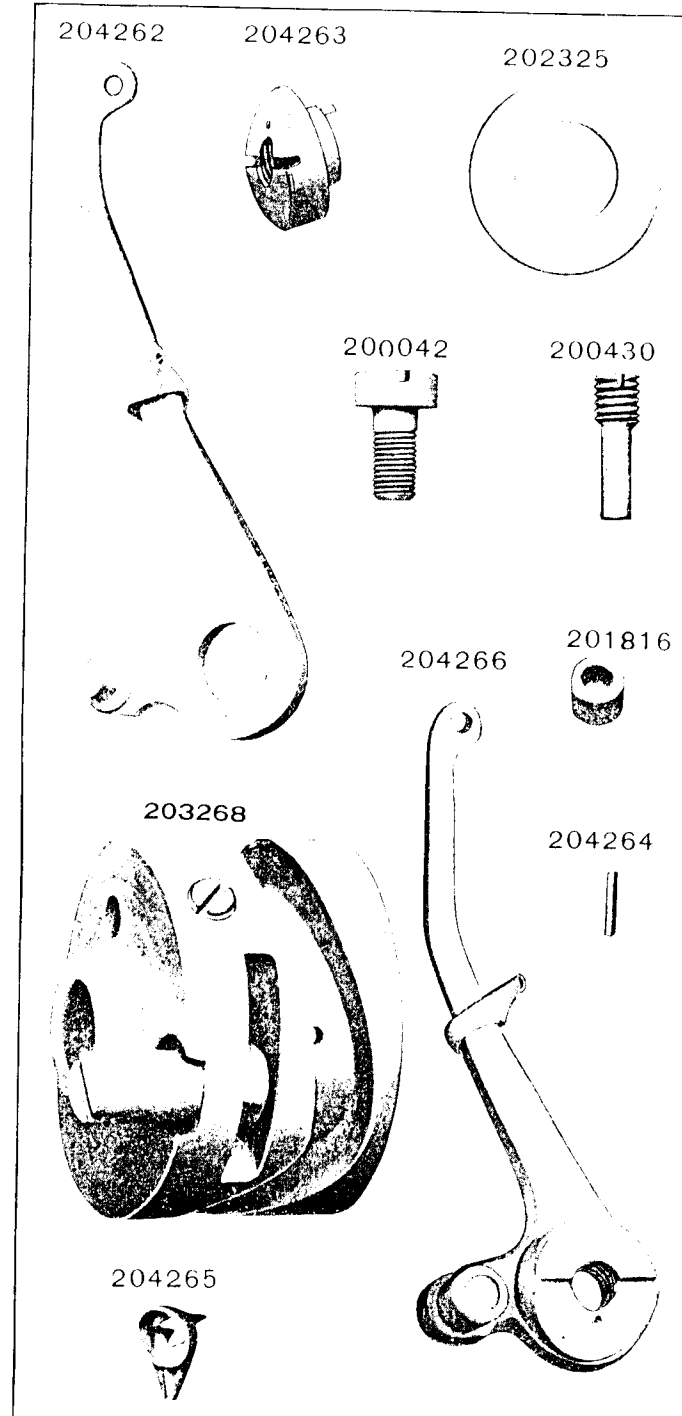


PLATE 11032-FULL SIZE

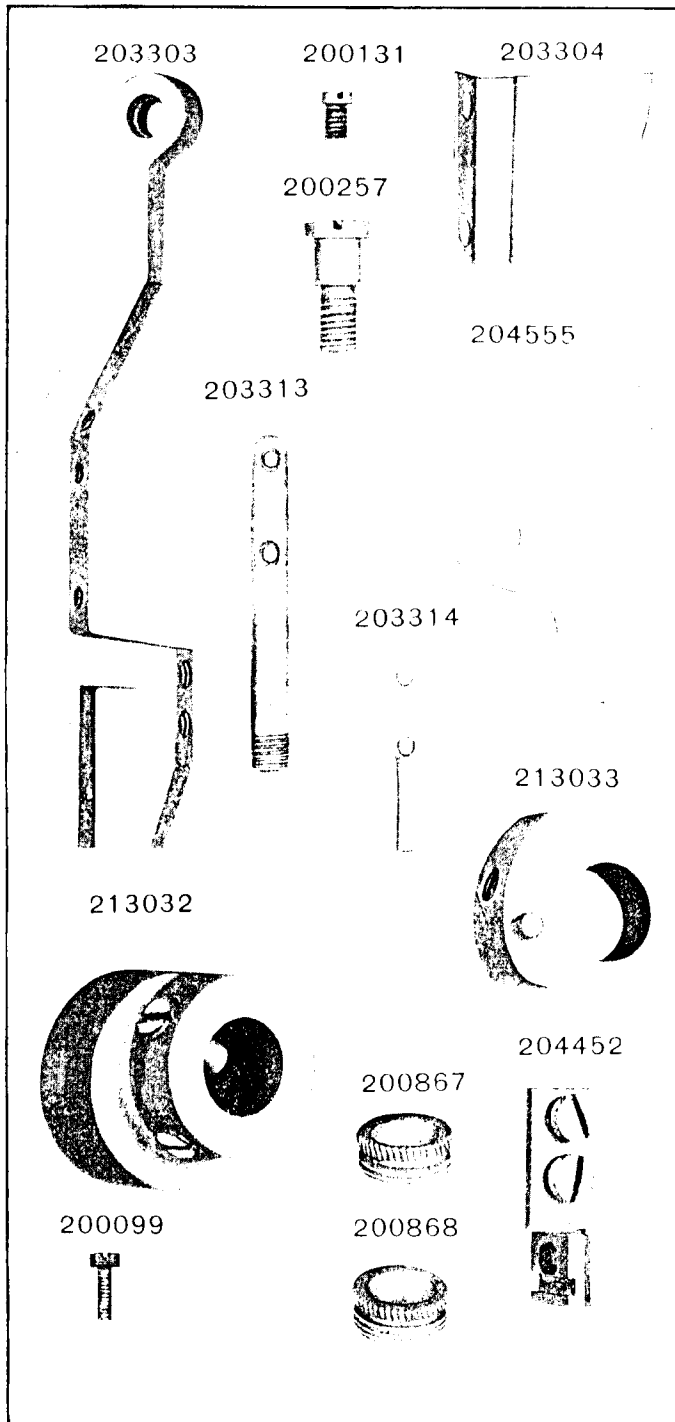
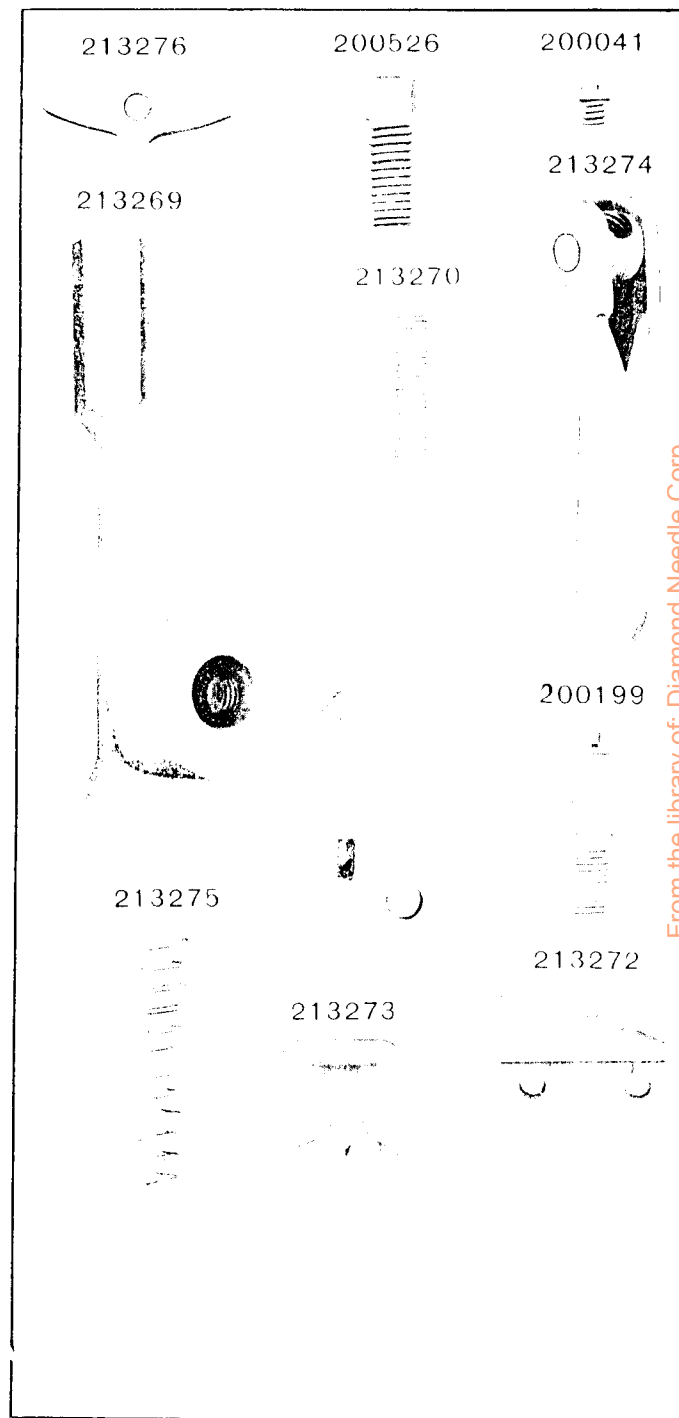


PLATE 11103-FULL SIZE



From the library of: Diamond Needle Corp

PLATE 11201—ONE-HALF SIZE

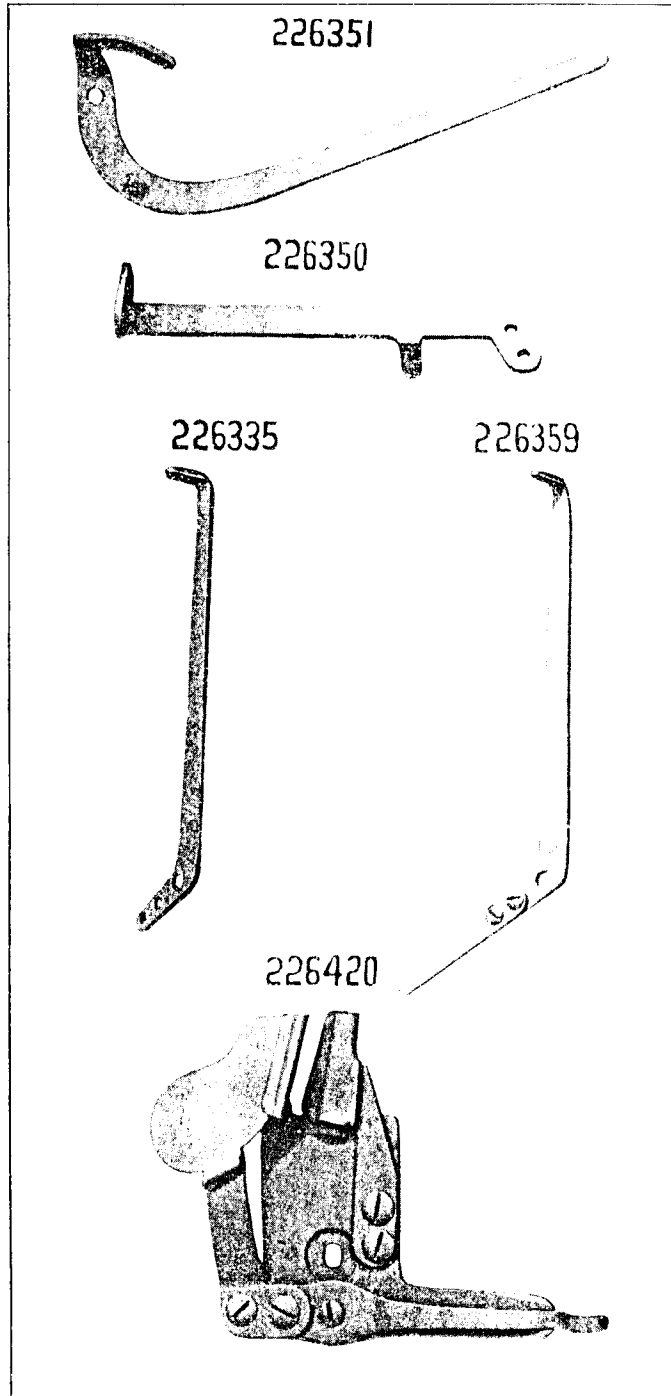
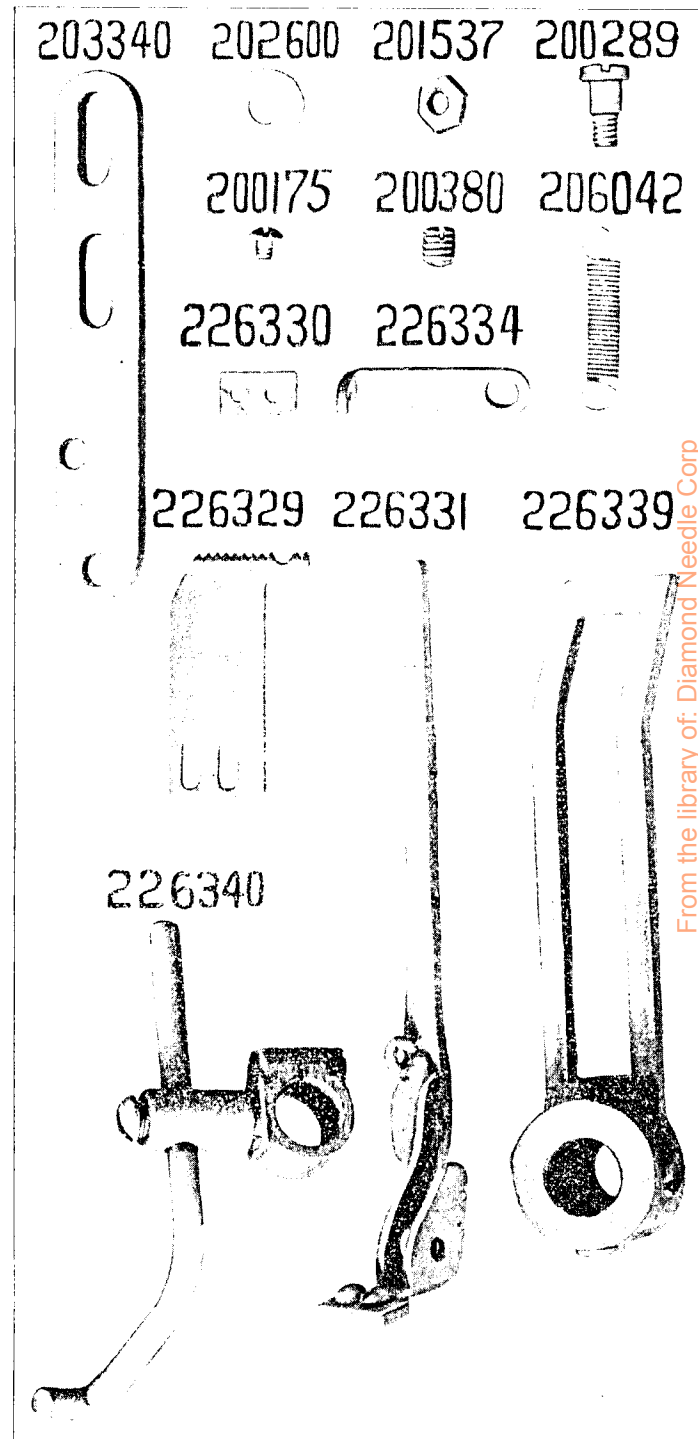


PLATE 11202—FULL SIZE

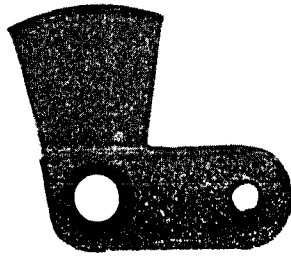


From the library of: Diamond Needle Corp

200909



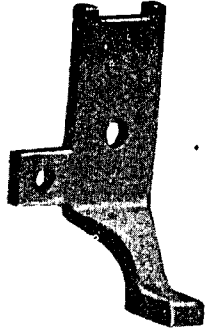
226347



226321



202994



200126



200162



200178



202062



226328



226327



203021



200659



201528



226352



226349



200363



200907



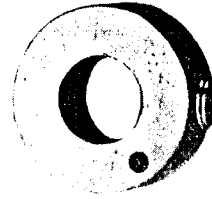
226336



226338



226356



200157



226337

203343



200284



200092



200174



200169



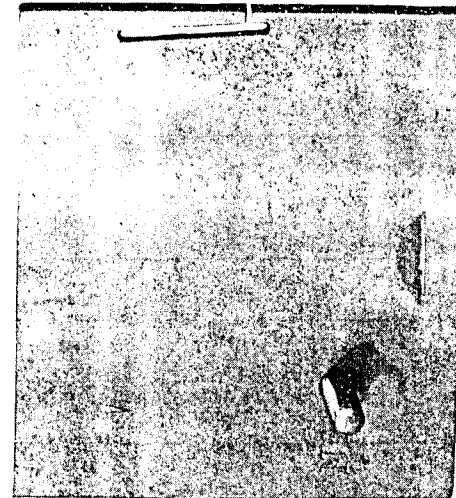
202104



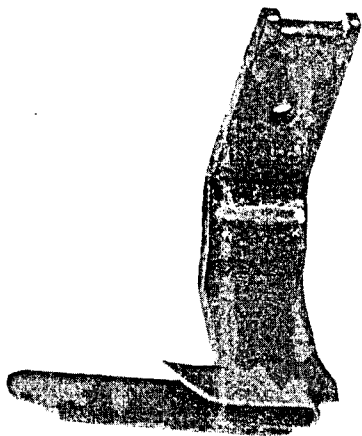
200305



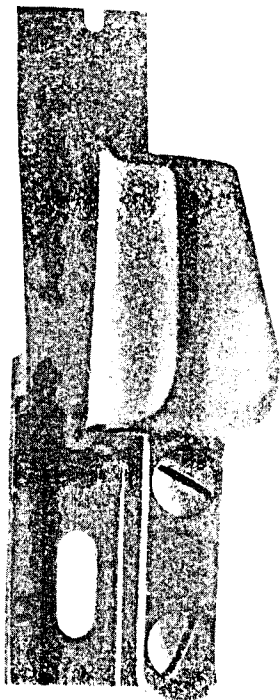
226491



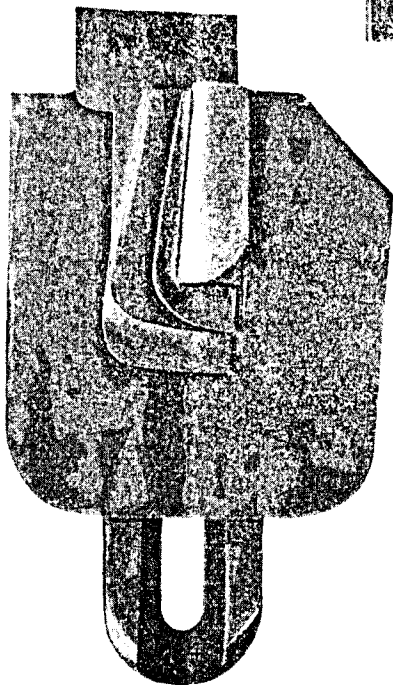
226365



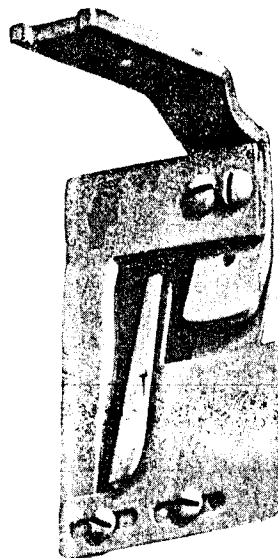
226368



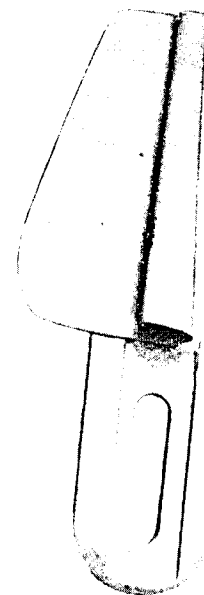
226361



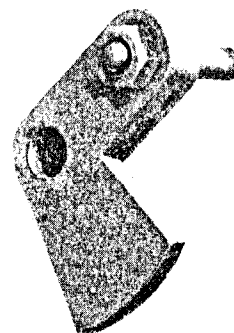
226372



226370

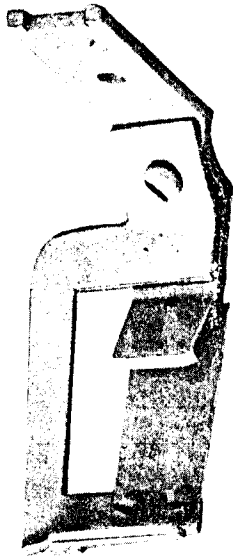


226348

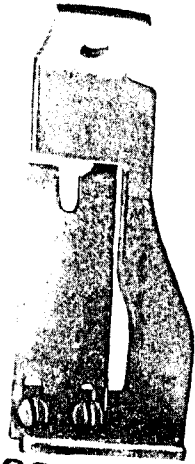


From the library of: Diamond Needle Corp

226379



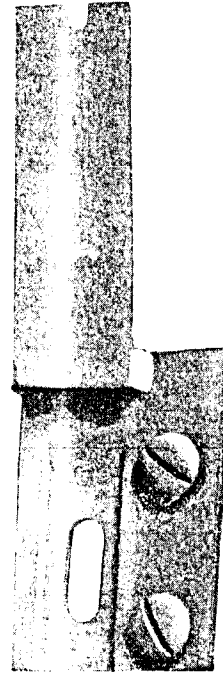
226385



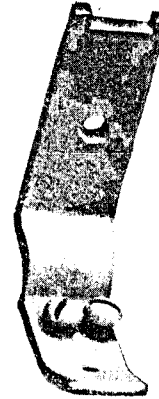
226530



226367



226371



226364



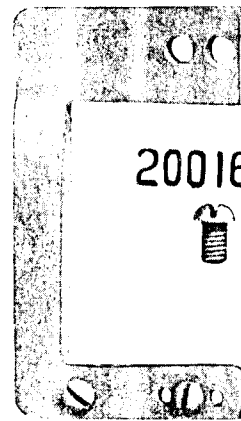
226376



200179



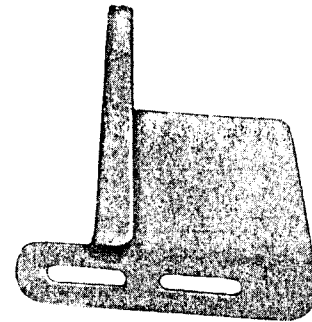
226374



200164



226373



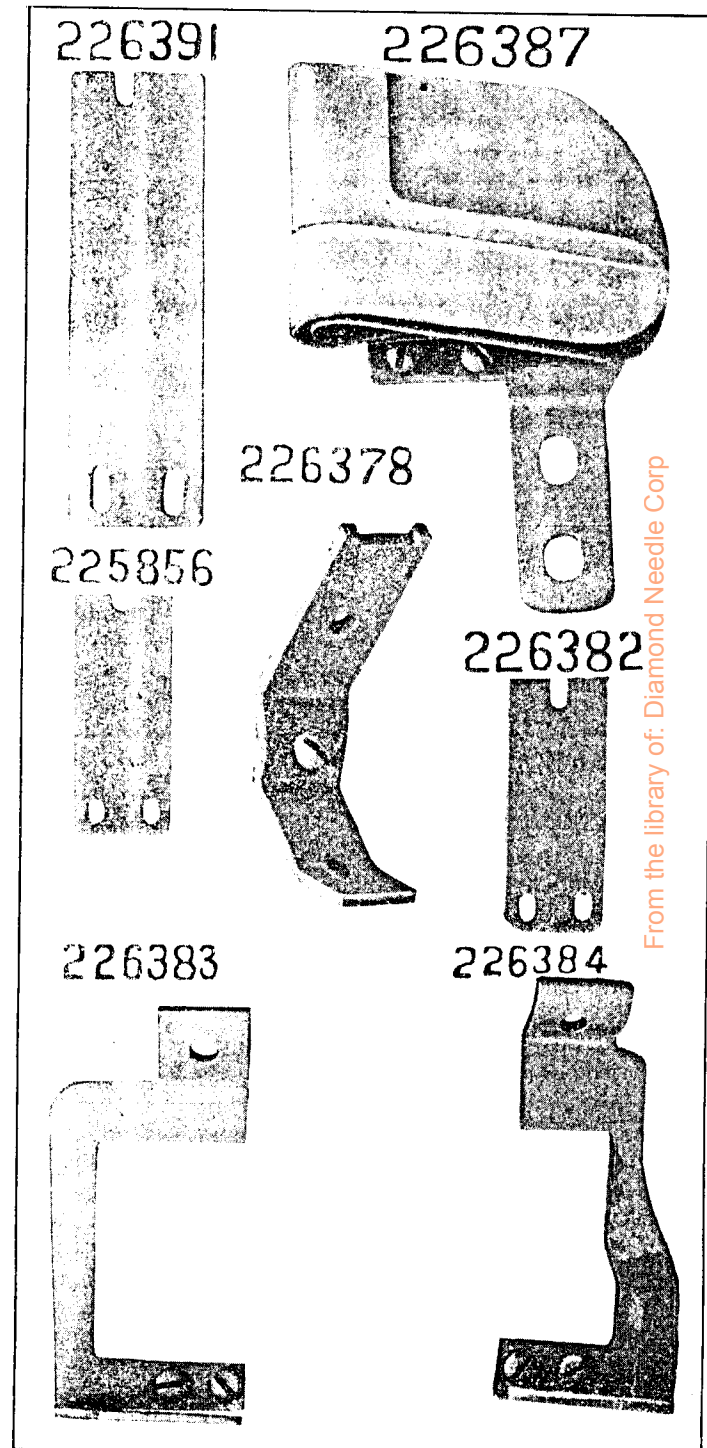
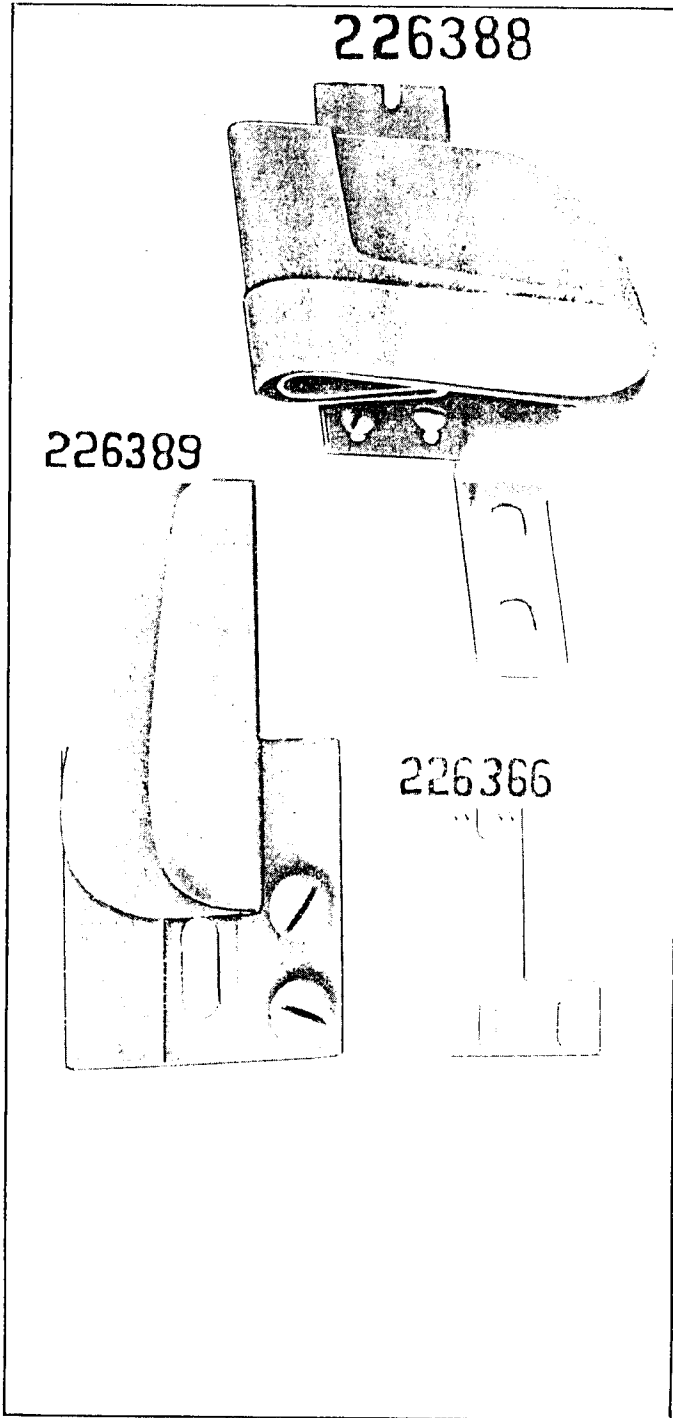


PLATE 11211—ONE-QUARTER SIZE

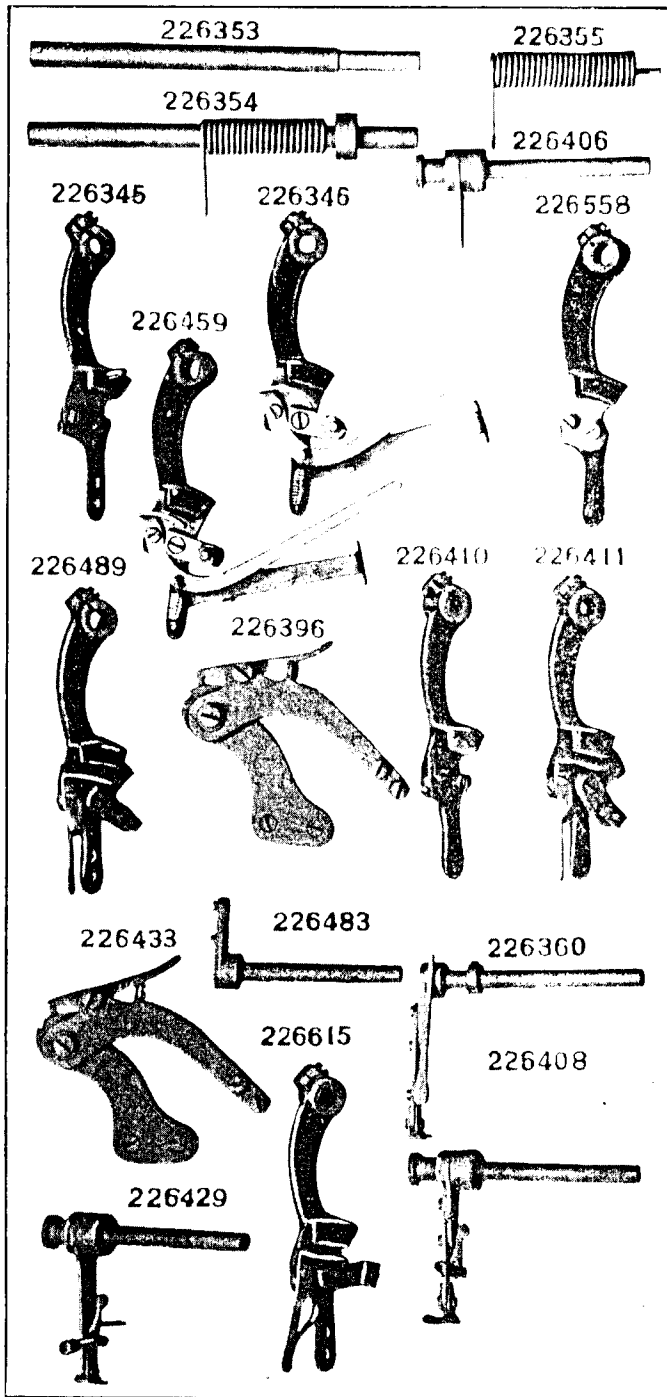
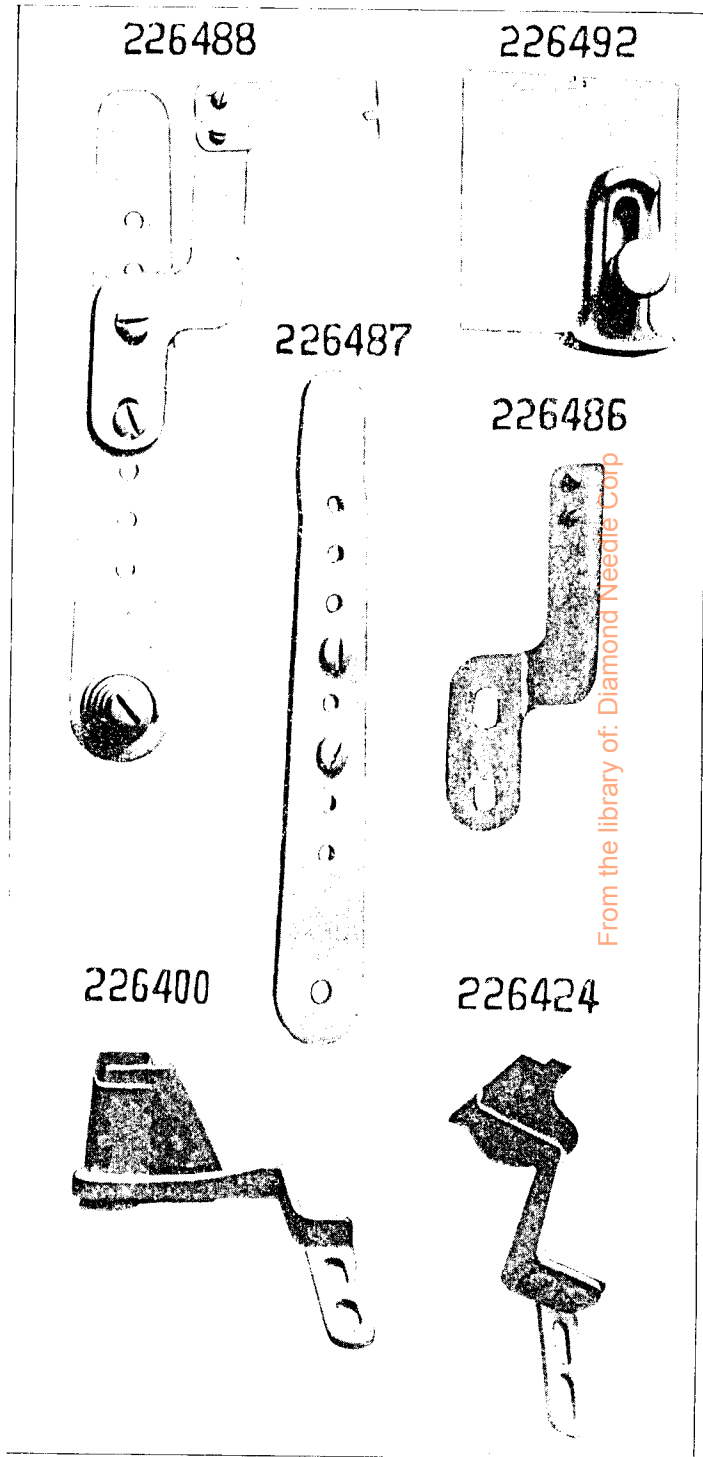
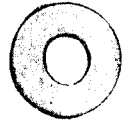


PLATE 11212—ONE-HALF SIZE



200272 228032 226398 226399



200911 226404 200187 226397



226409

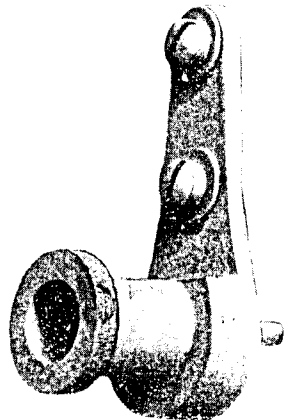
226402



202613



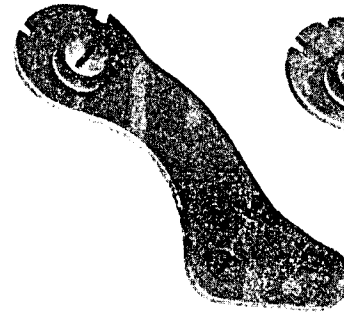
226405



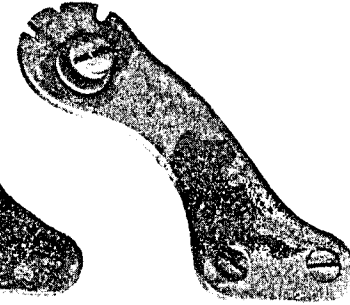
200160



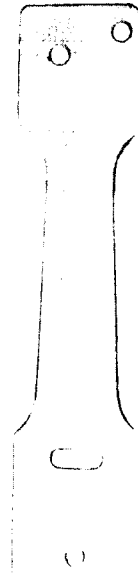
226395



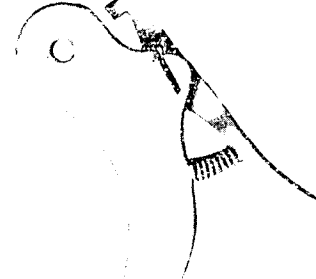
226432



226451



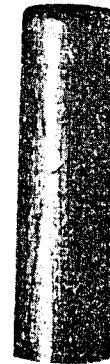
226394

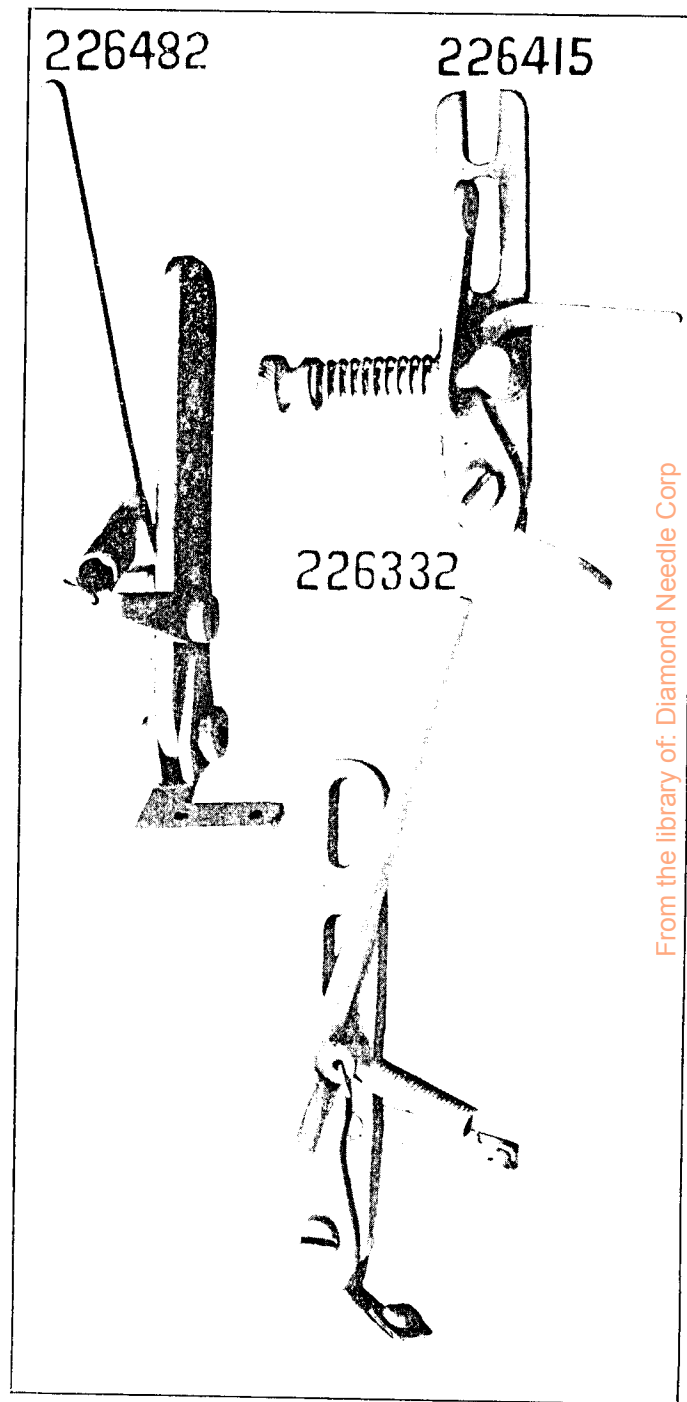
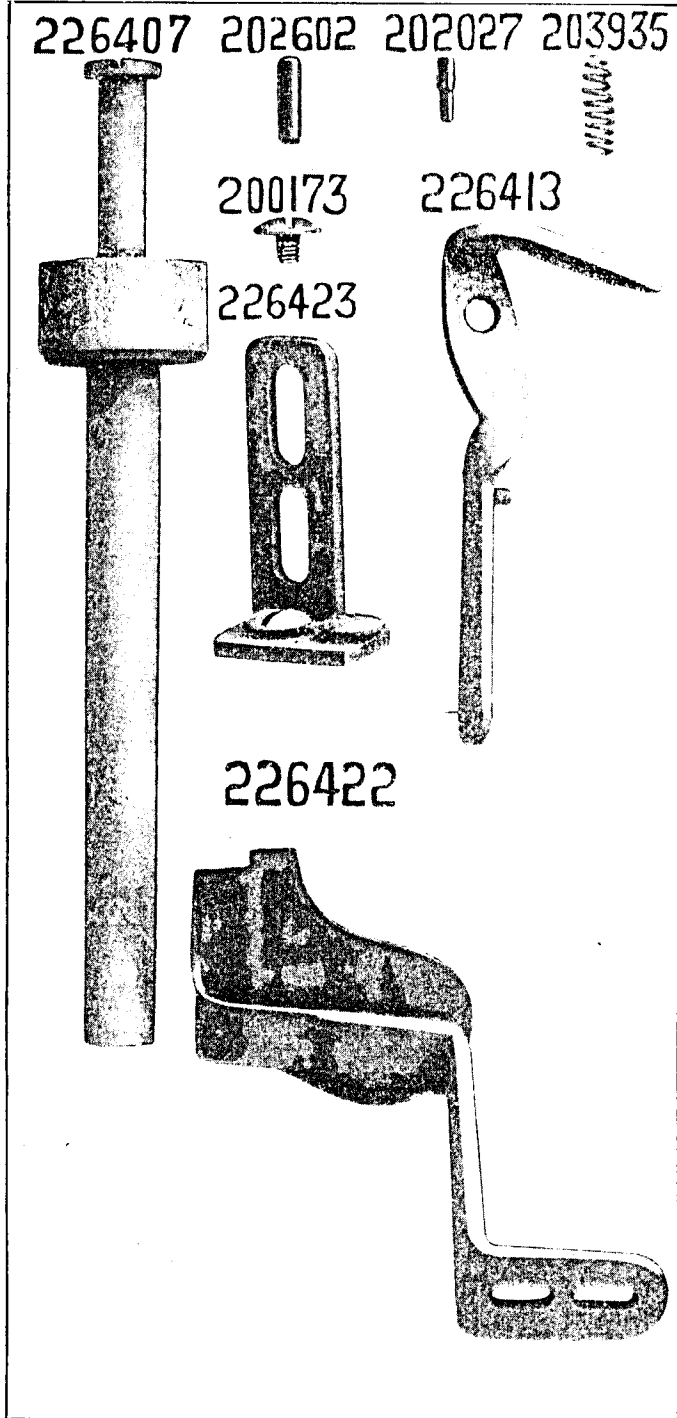


226393



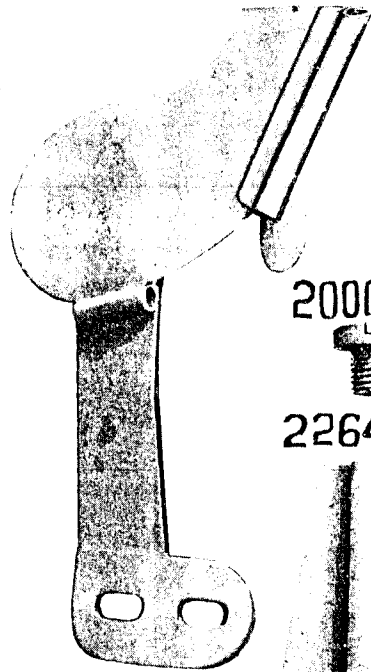
226449



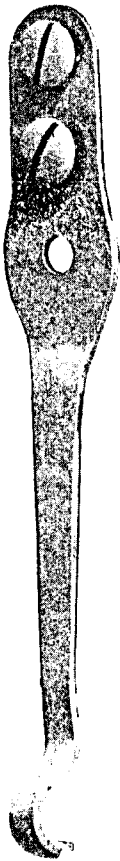


From the library of: Diamond Needle Corp

226418



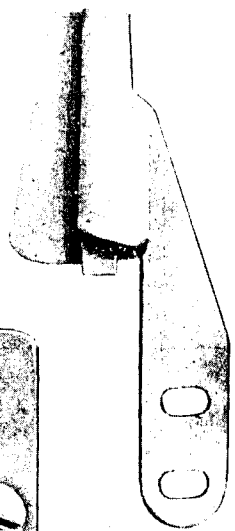
226416



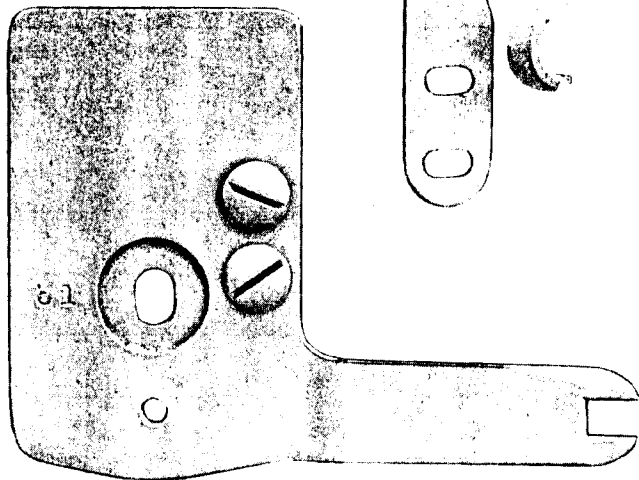
200093



226421



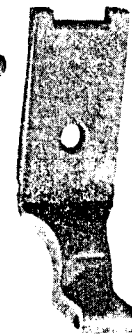
226419



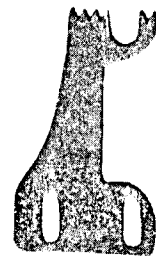
202837



202924



226427



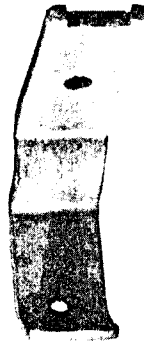
226437



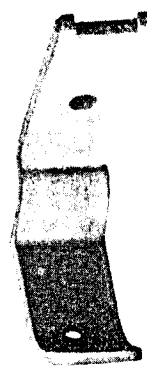
226438



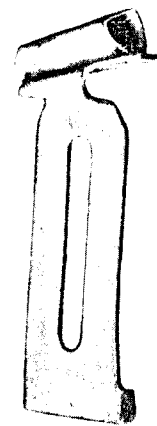
226426



226426



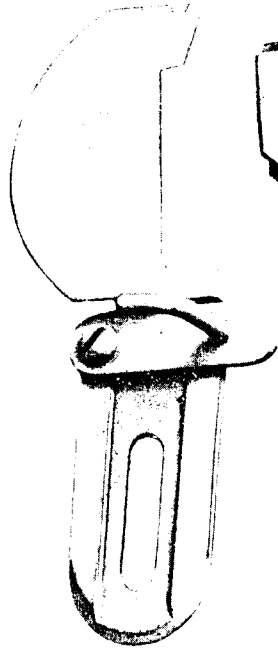
226434



From the library of: Diamond Needle Corp

PLATE 11219-FULL SIZE

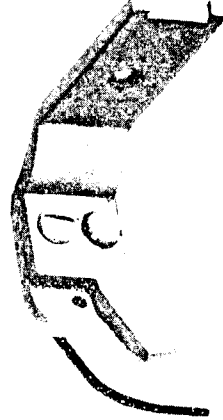
226441



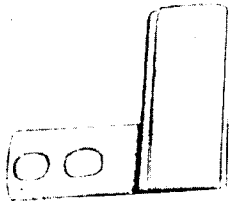
226434



226475



226468



226326

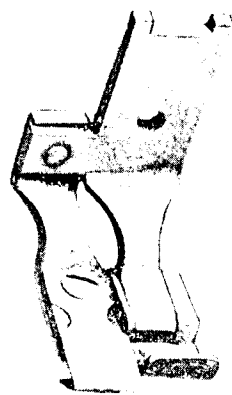


PLATE 11220-FULL SIZE

200369



200855



201563



201526



225925



225735

226110

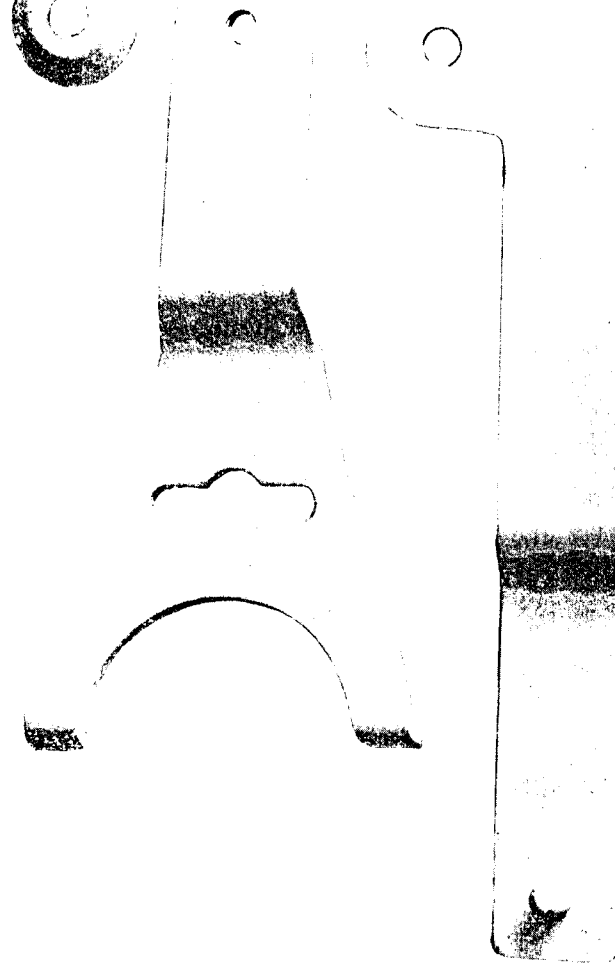


PLATE 11221—FULL SIZE

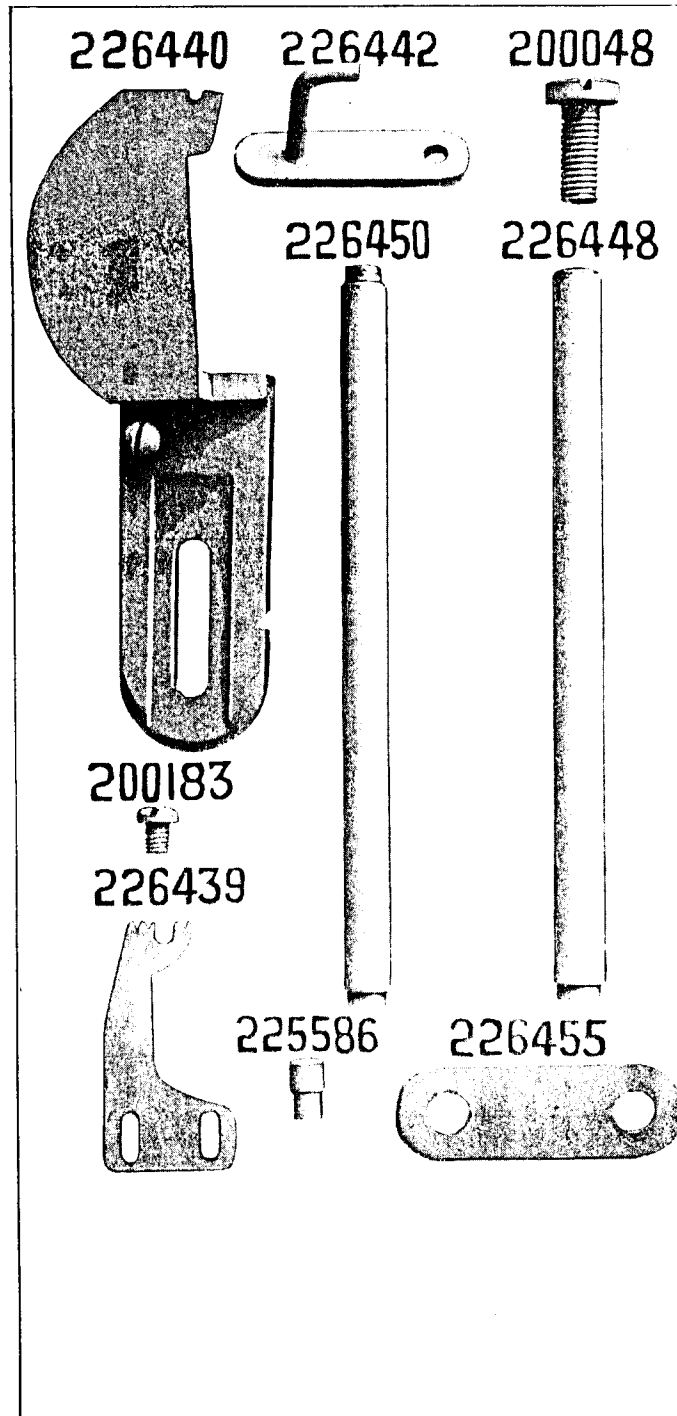


PLATE 11222—ONE-FOURTH SIZE

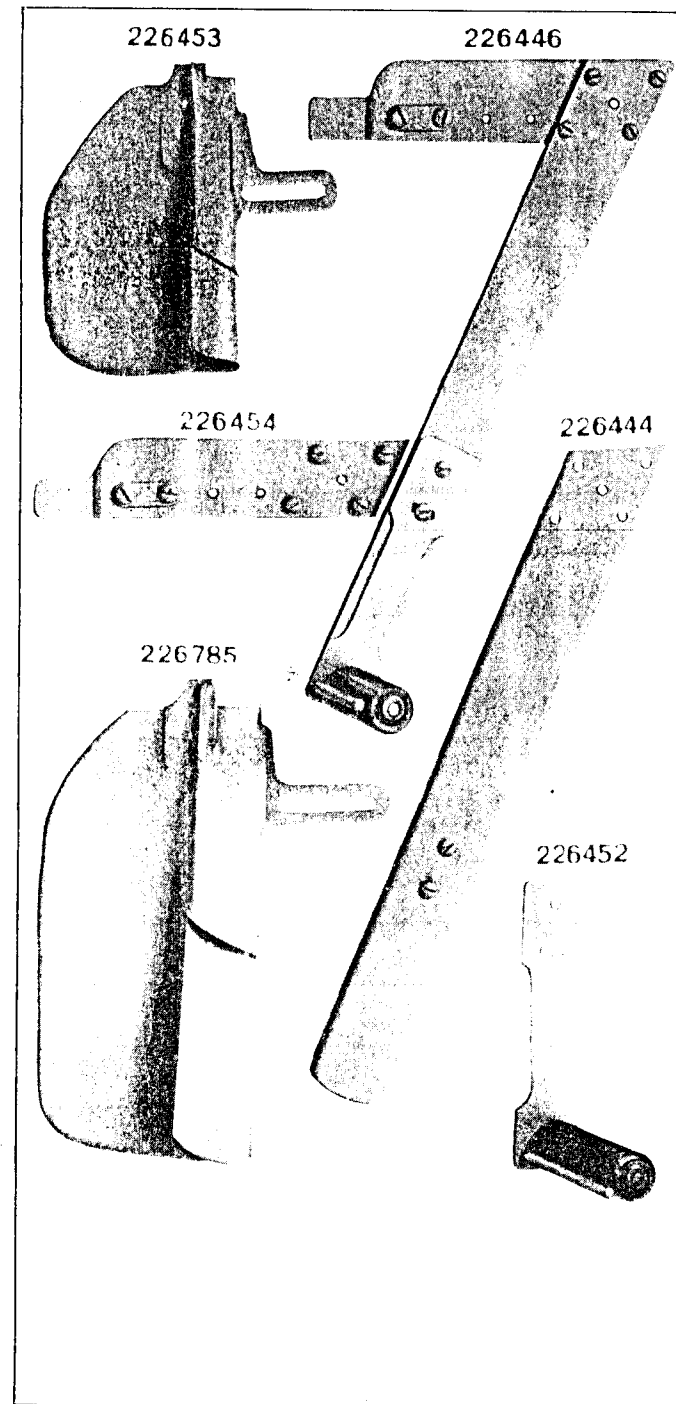


PLATE 11223—FULL SIZE

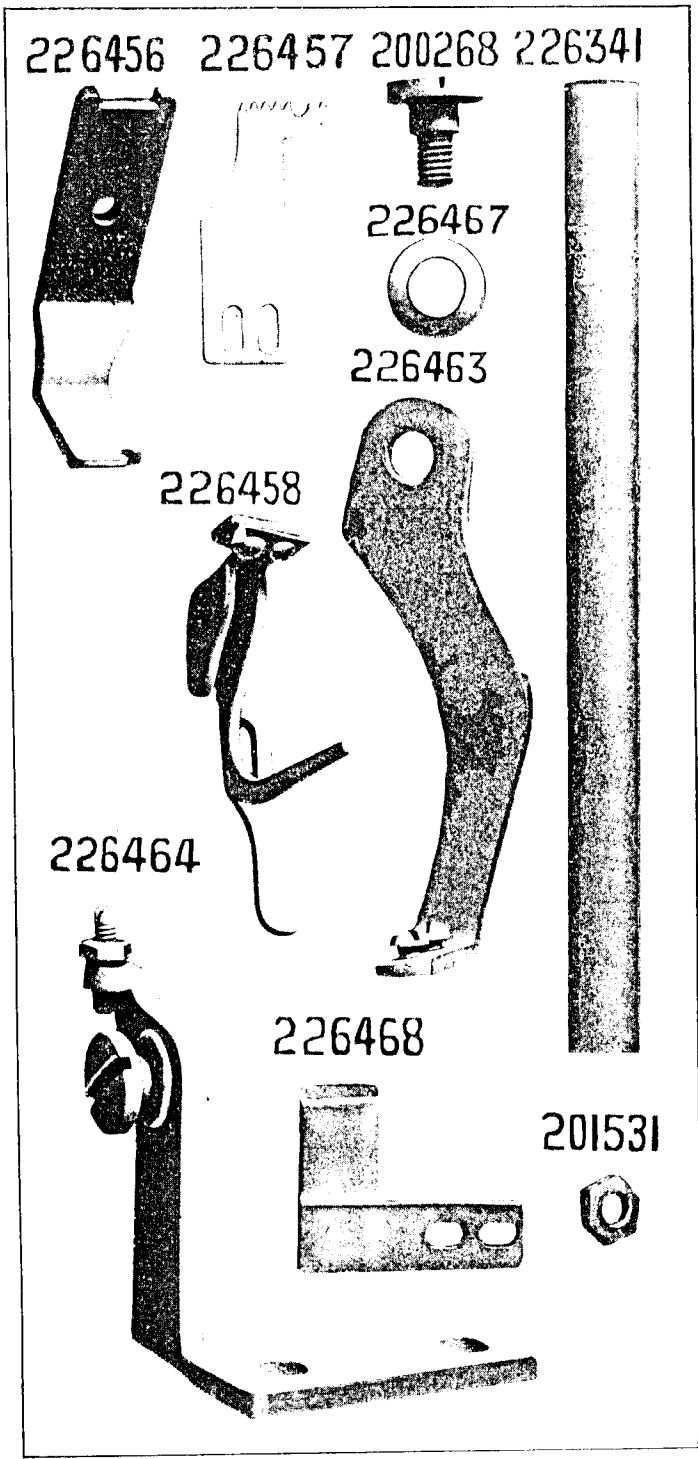
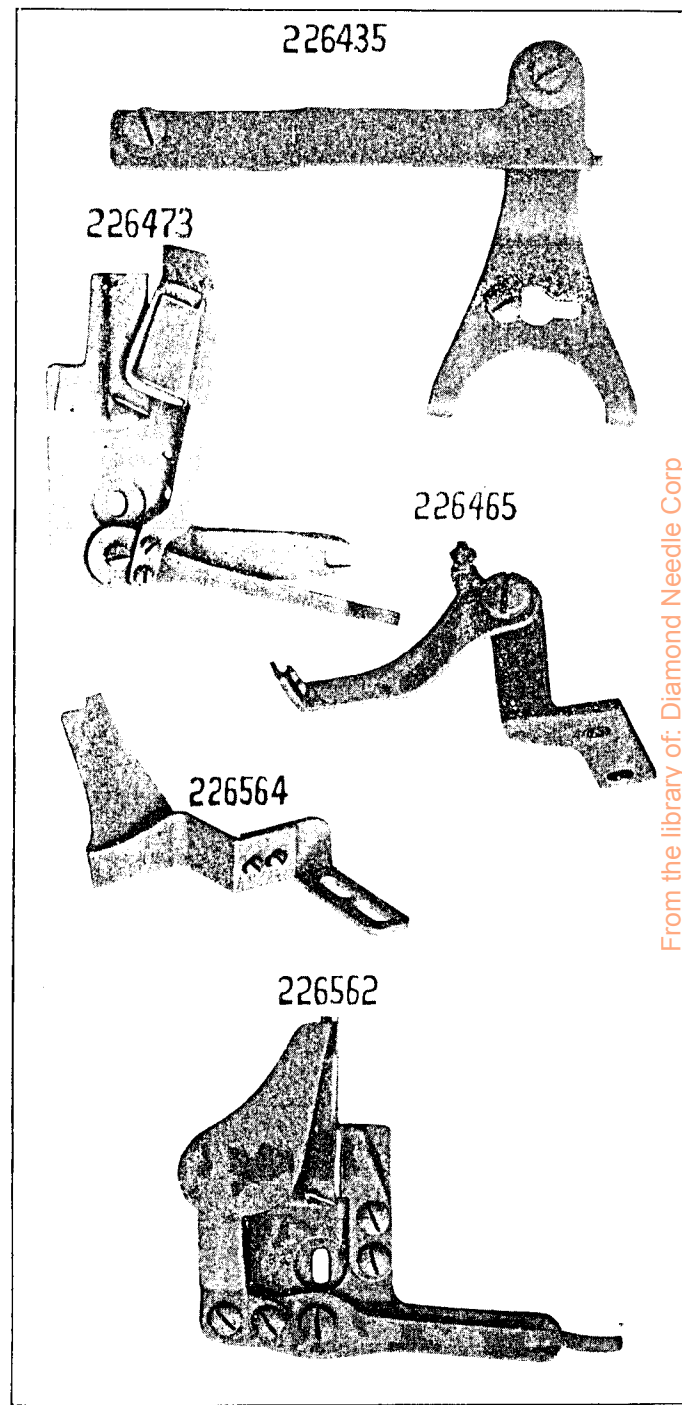


PLATE 11224—ONE-HALF SIZE



From the library of: Diamond Needle Corp

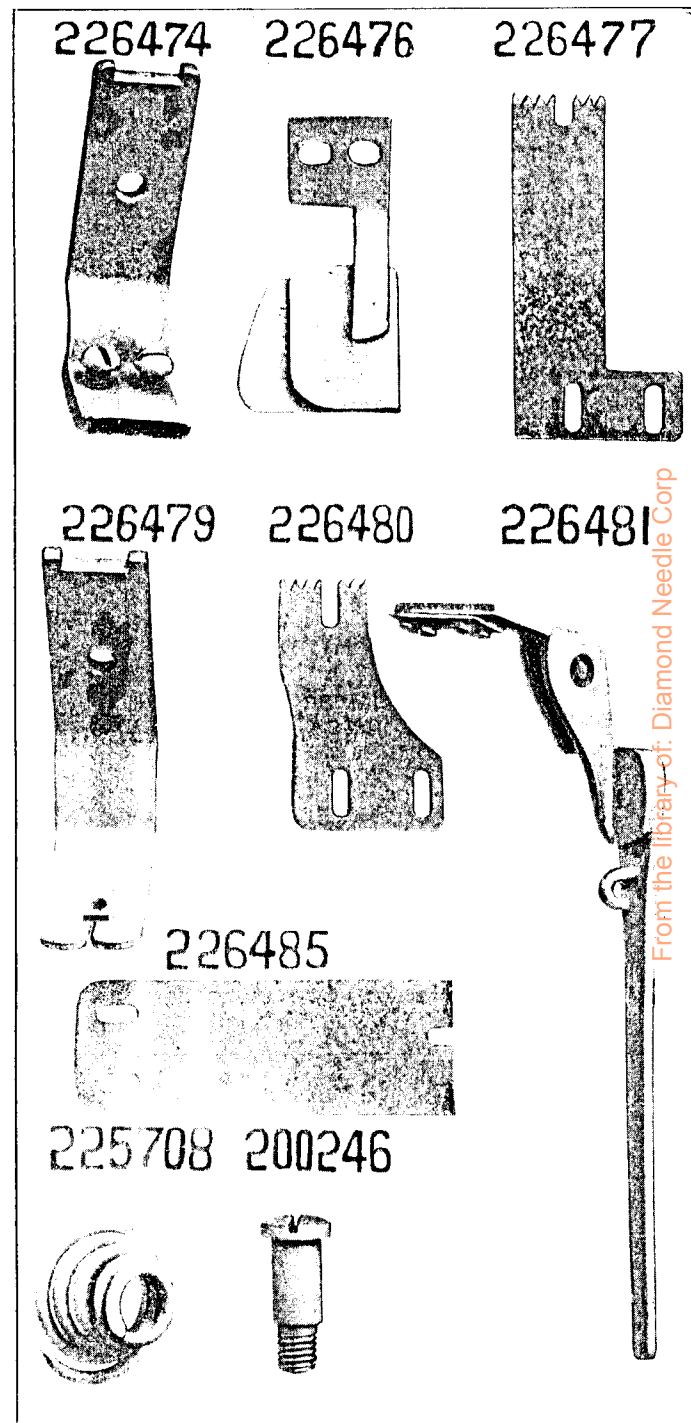
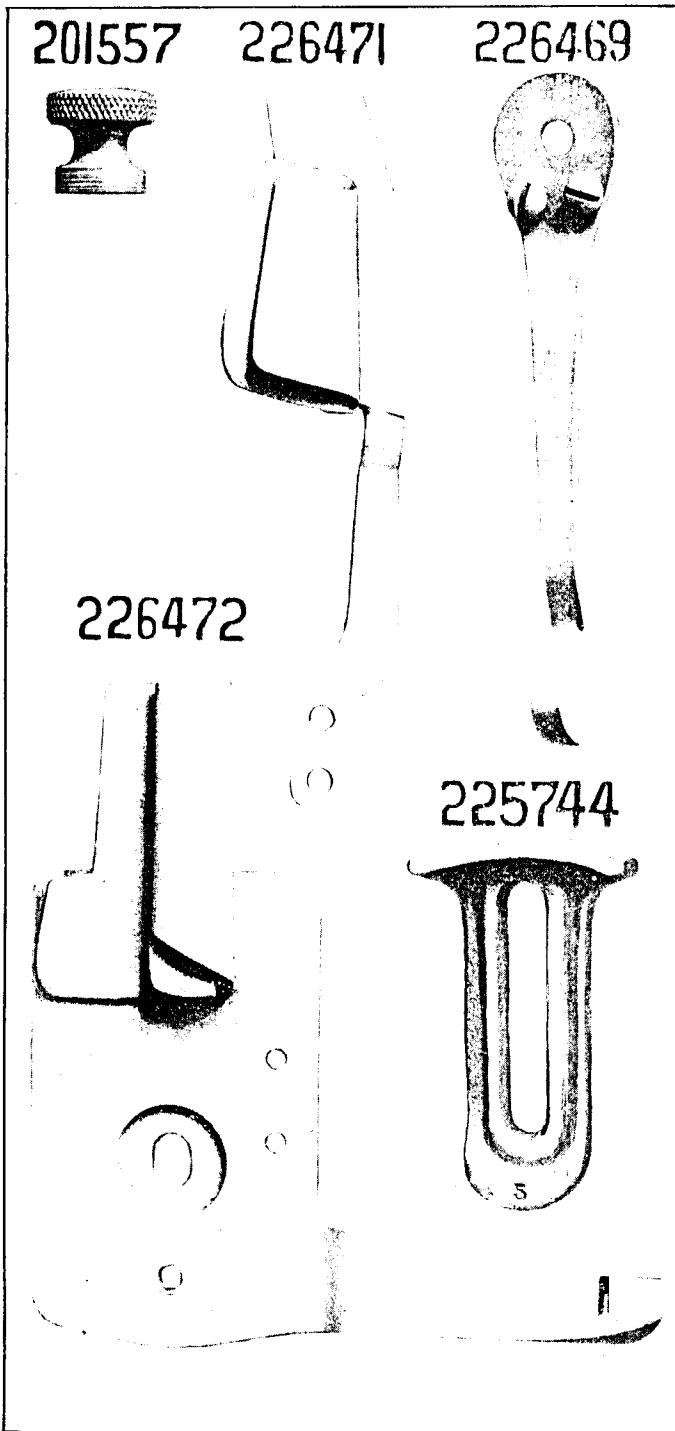
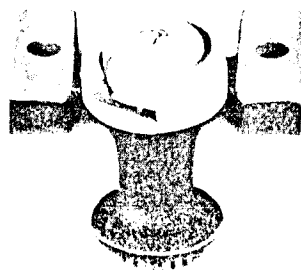


PLATE 11227—ONE-HALF SIZE

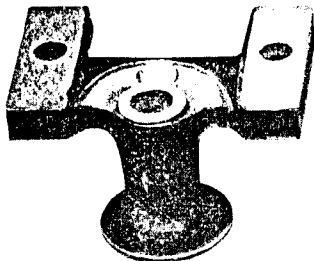
203254



203253



203252



203240



203253

No 2 OUTFIT

203208



203209



203210



203241



11227

213192

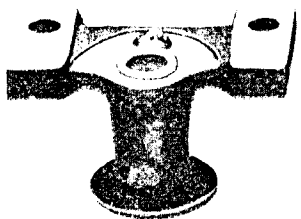


PLATE 11228—FULL SIZE

203208



203214



203209

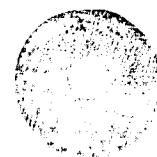


203215

203217



203216



203210



203254

200600

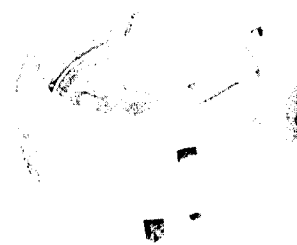
20325

200593

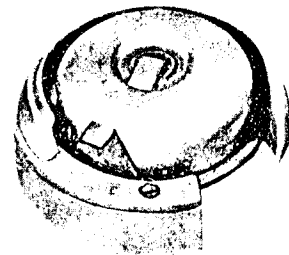
200616

200594

203240

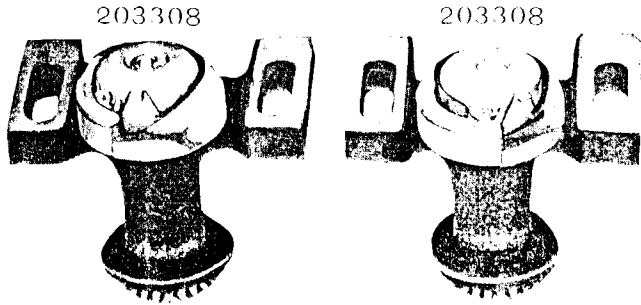


203290



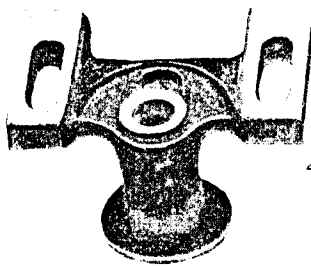
From the library of: Diamond Needle Corp

PLATE 11229—ONE-HALF SIZE



203462

№ 2 OUTFIT



203307

203240

203254

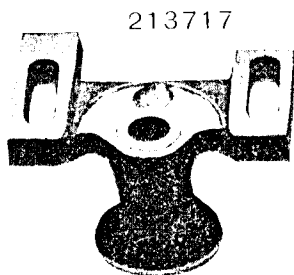
203254

203208

203209

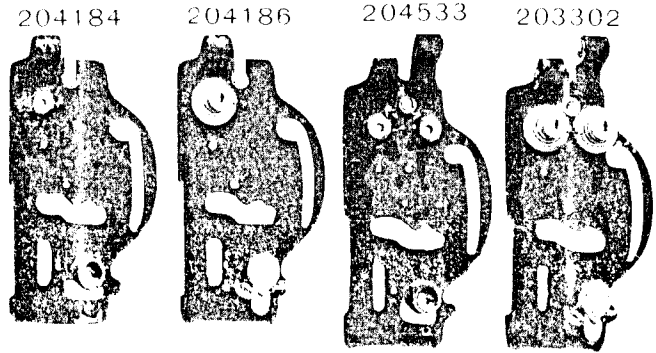
203210

203241



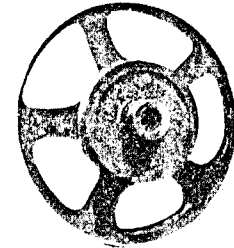
213717

PLATE 11301—ONE FOURTH SIZE



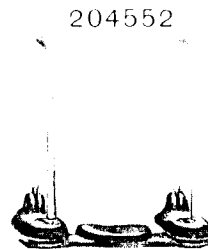
203327 203247 204294

203204

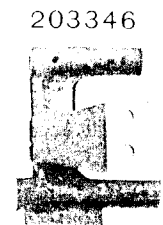


204804

203329



204552



203346

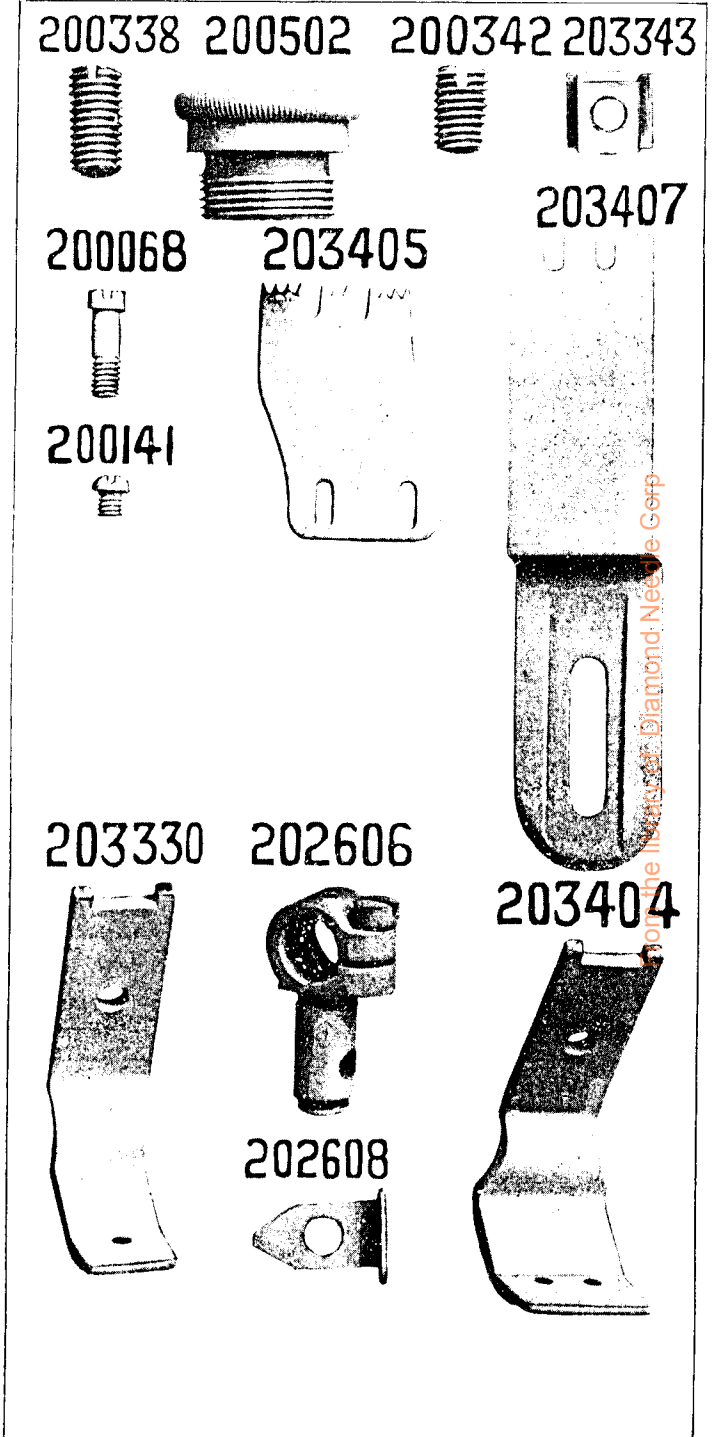


PLATE 11304—ONE FOURTH SIZE

204827 203403 204251 203306 203243

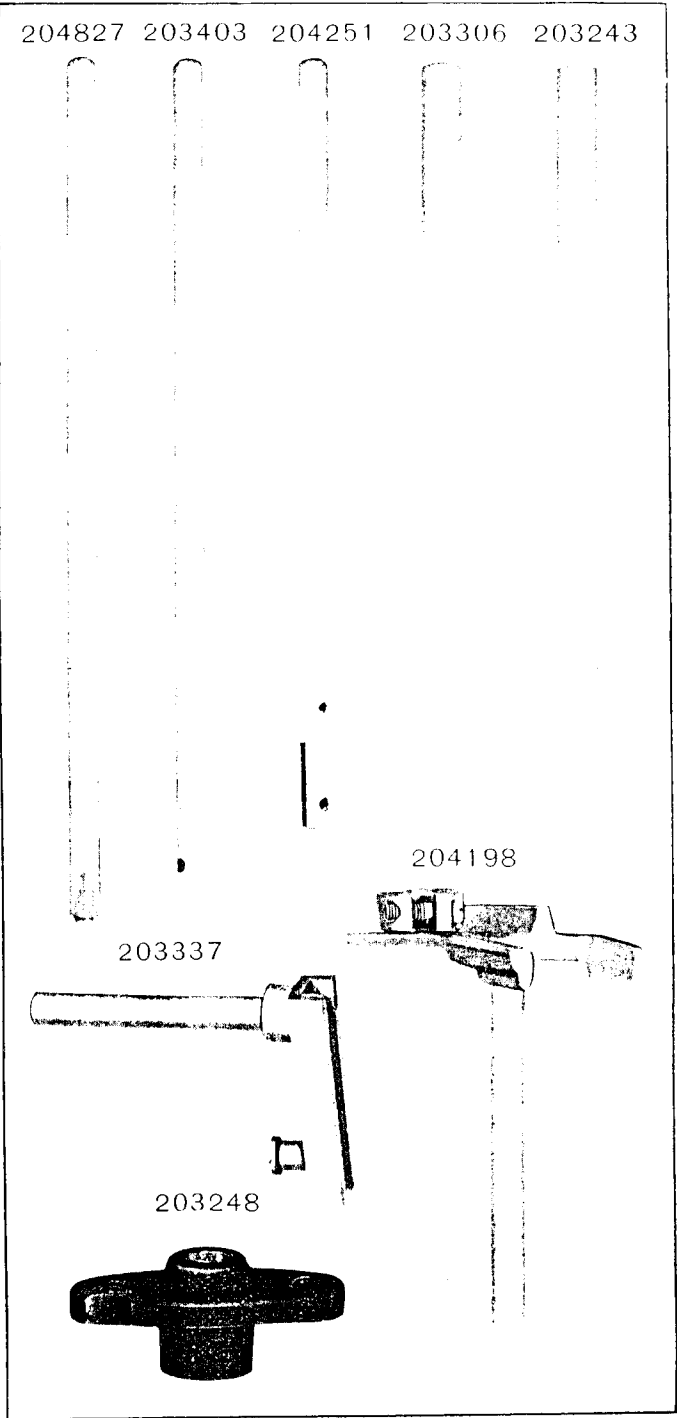
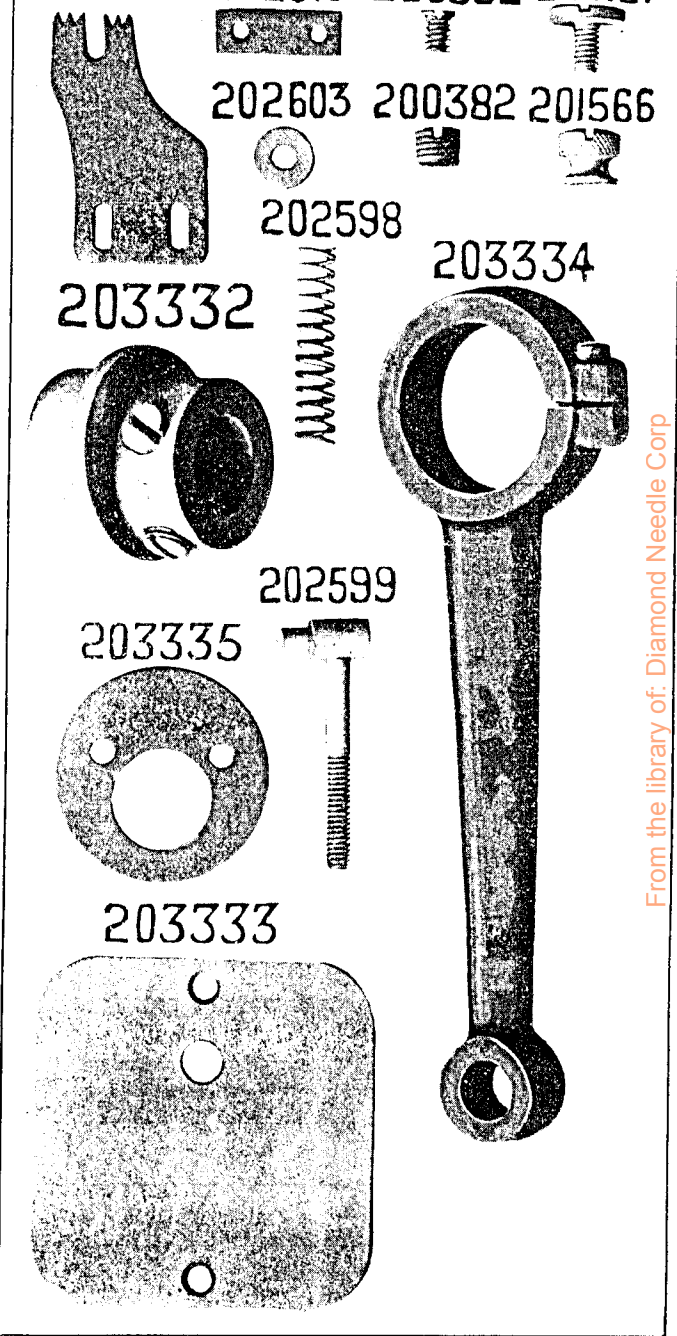
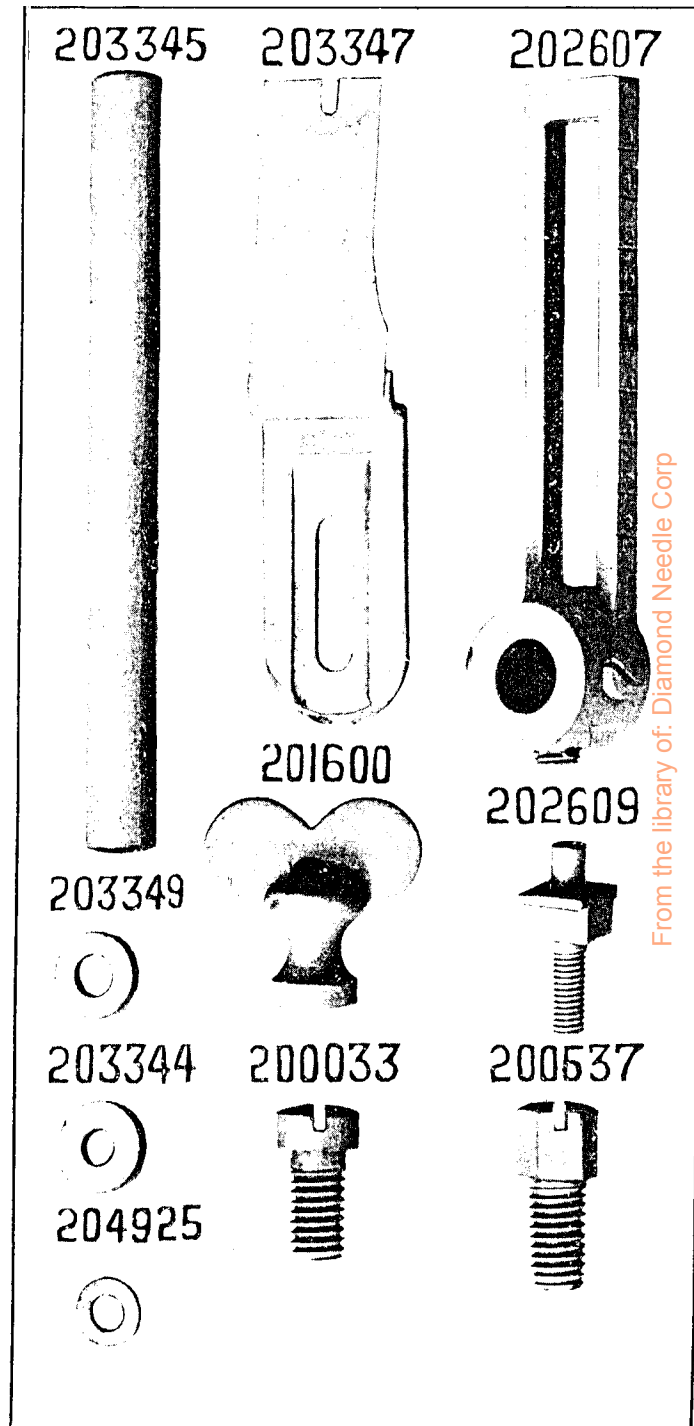
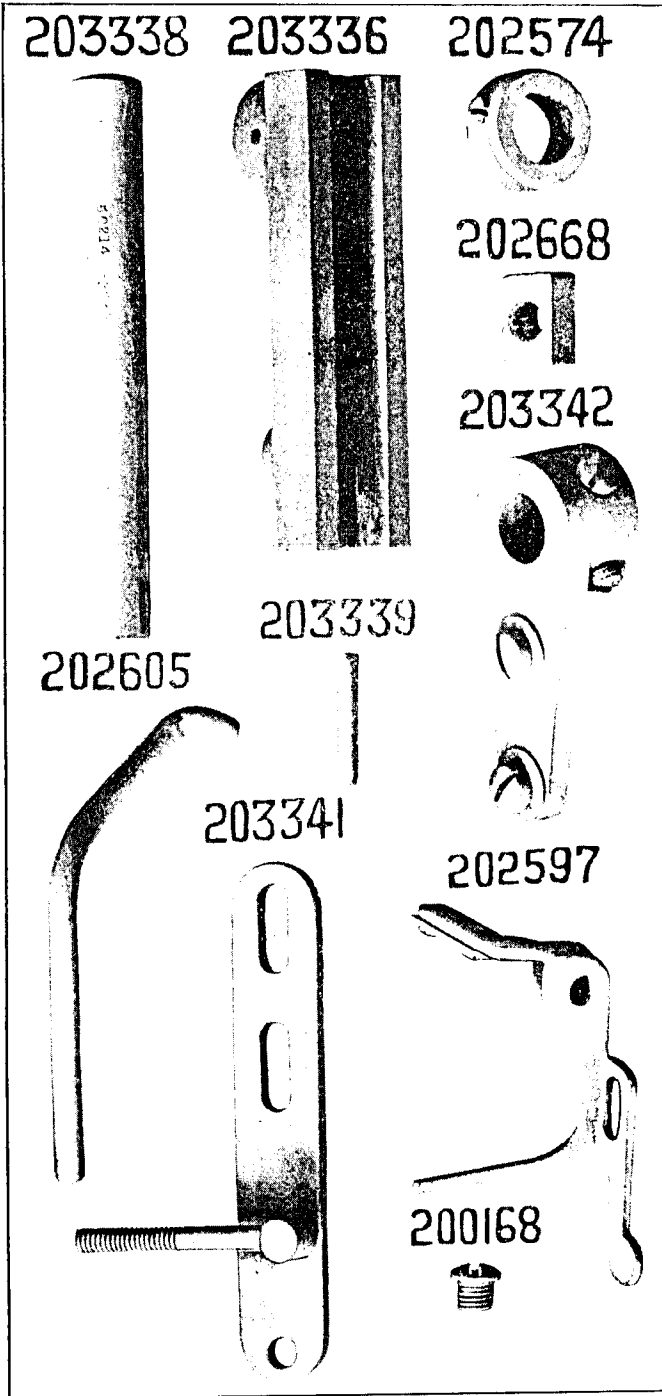


PLATE 11305—FULL SIZE

203331 202610 200582 200101

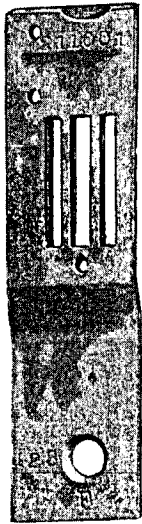


From the library of: Diamond Needle Corp



From the library of: Diamond Needle Corp

211001



211002



211007



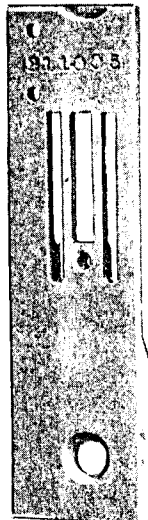
211006



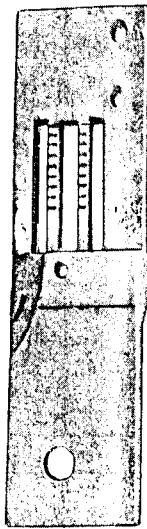
211003



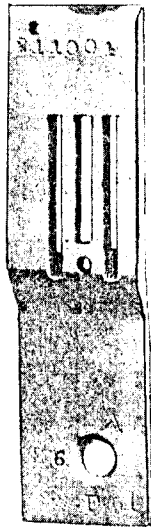
211005



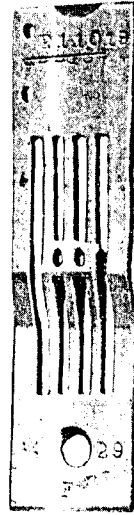
211001



211004



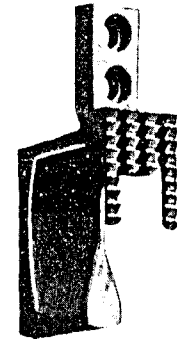
211019



211019



211020



211022



211021



211045

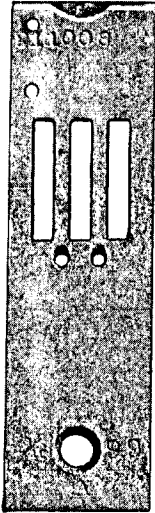


211044

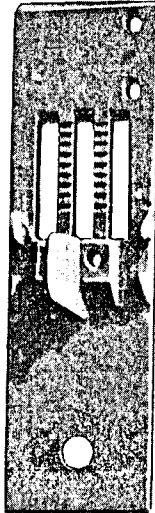


PLATE 11355—FULL SIZE

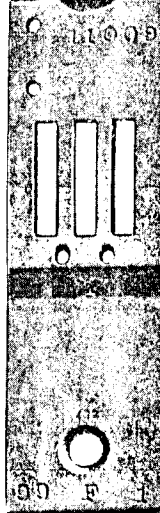
211008



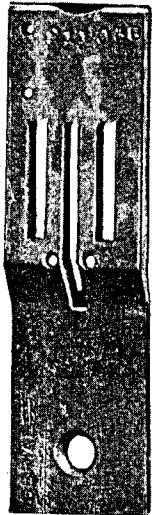
211008



211009



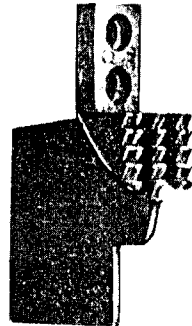
211036
211037



211010



211038



211009

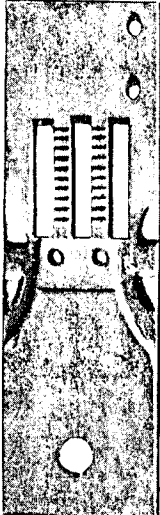
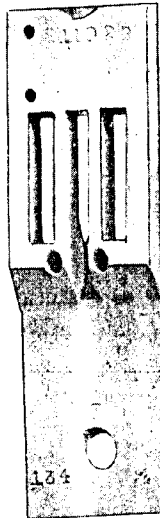
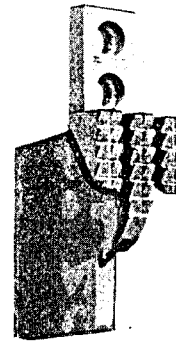


PLATE 11356—FULL SIZE

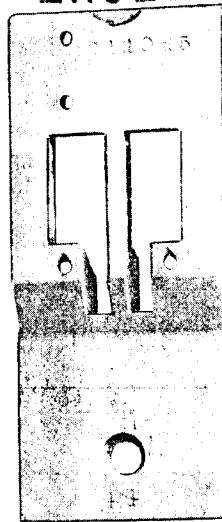
211028
211029



211030



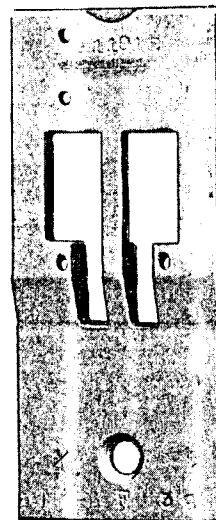
211025
211026



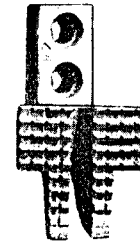
211044



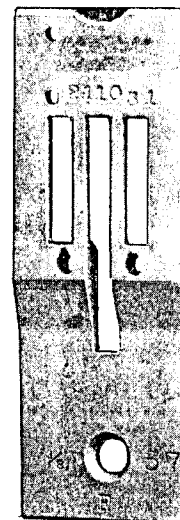
211012
211013



211027



211031
211032



211014

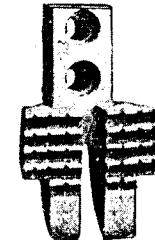
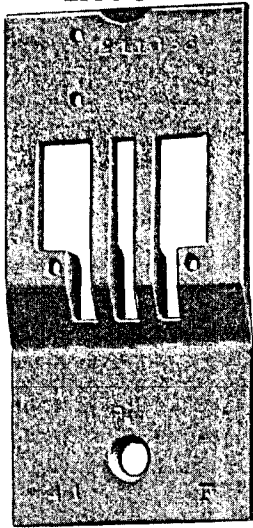
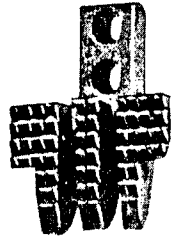


PLATE 11357—FULL SIZE

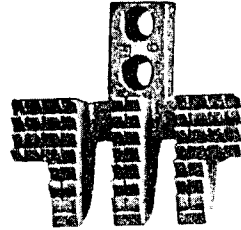
211033
211034



211035



211017



211015
211016

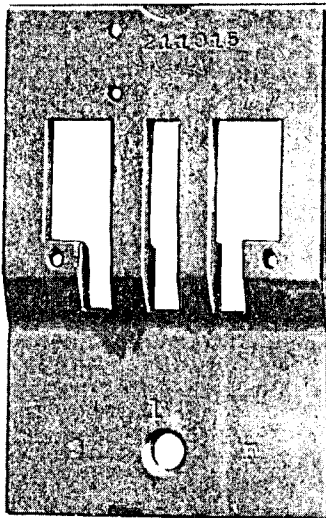
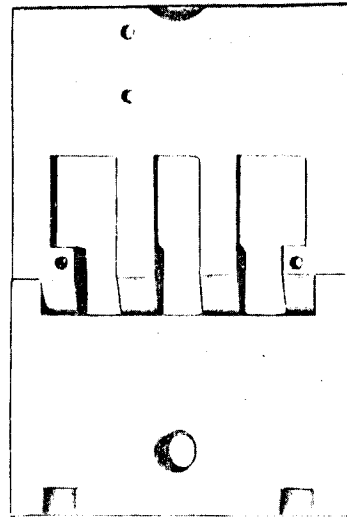
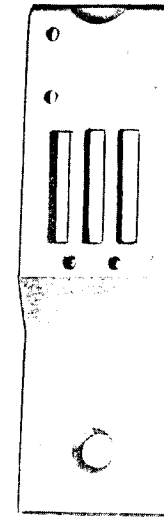


PLATE 11358—FULL SIZE

211039
211040



211011



211041

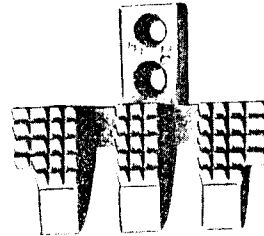


PLATE 11500-FULL SIZE

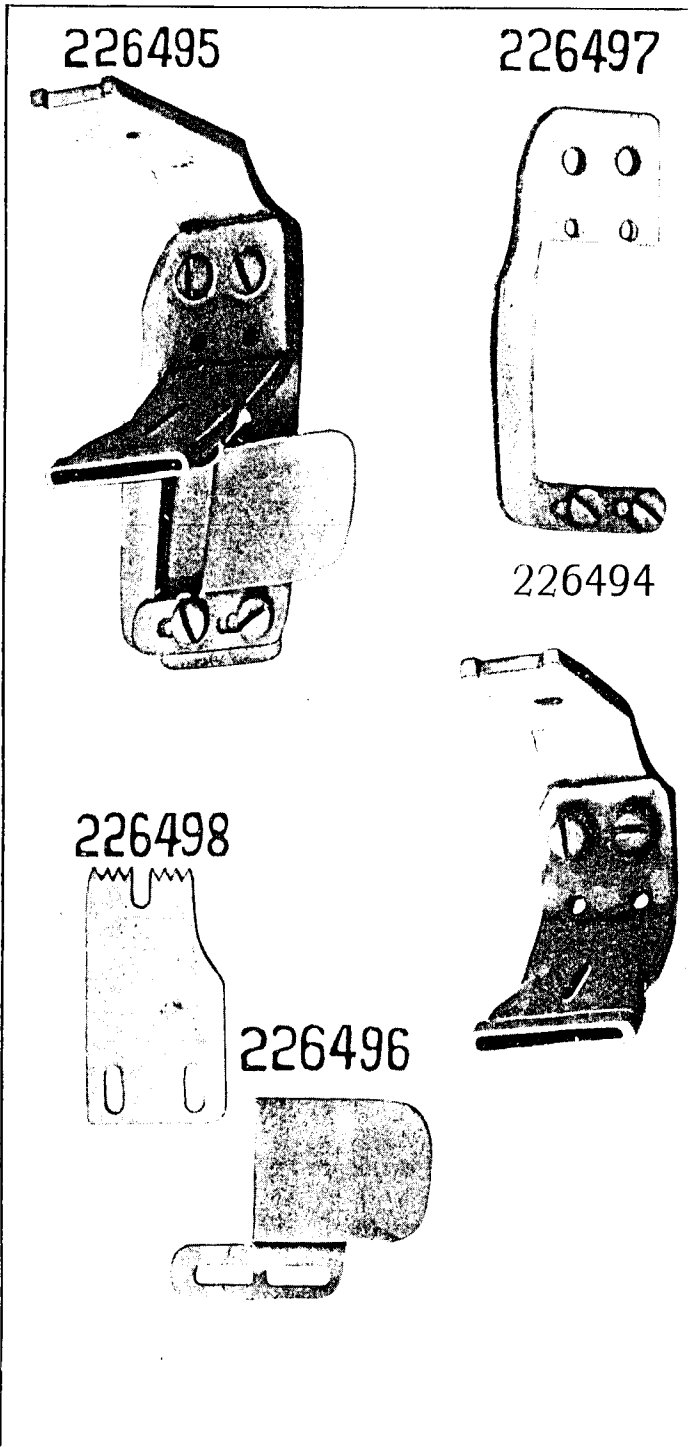
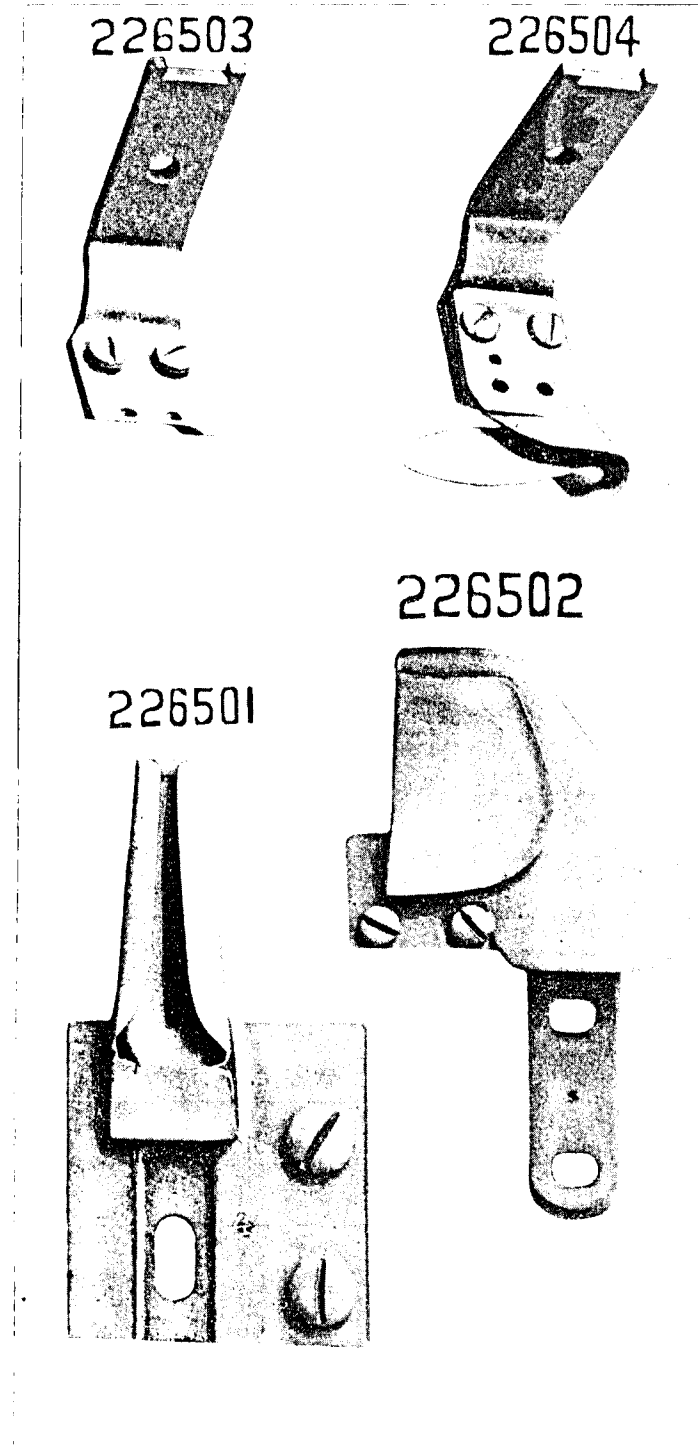
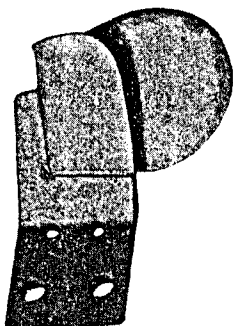


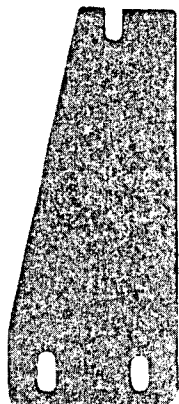
PLATE 11501-FULL SIZE



226505



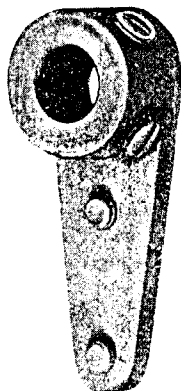
226507



226506



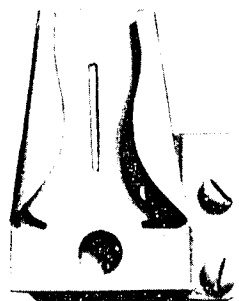
226513



226514



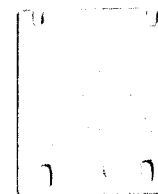
226509



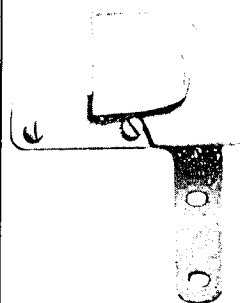
226512



226515



226510



226511



226524



226525



226526



226527

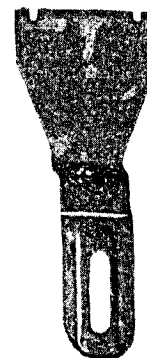
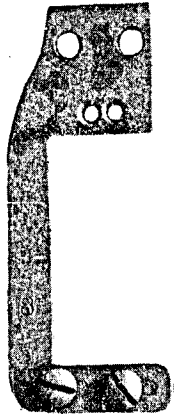
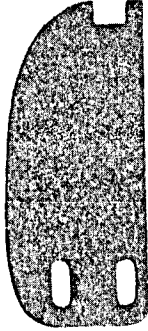


PLATE 11504—FULL SIZE

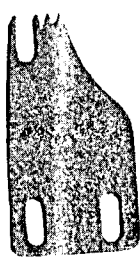
226520



226522



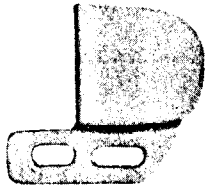
226521



226518



226519



226517

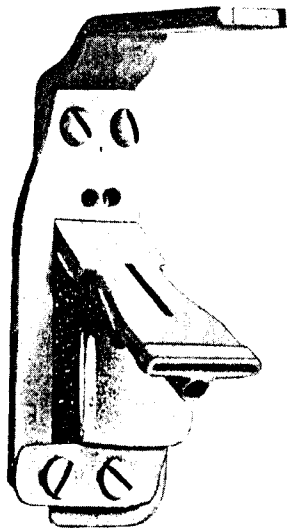


PLATE 11505—FULL SIZE

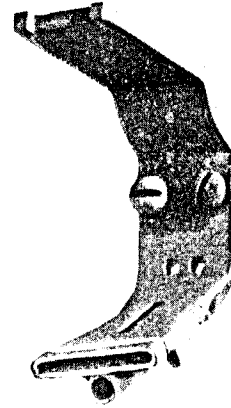
226532



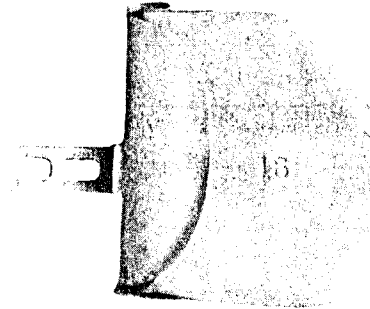
226535



226529



226531



226534



226499



PLATE 11506—ONE-HALF SIZE

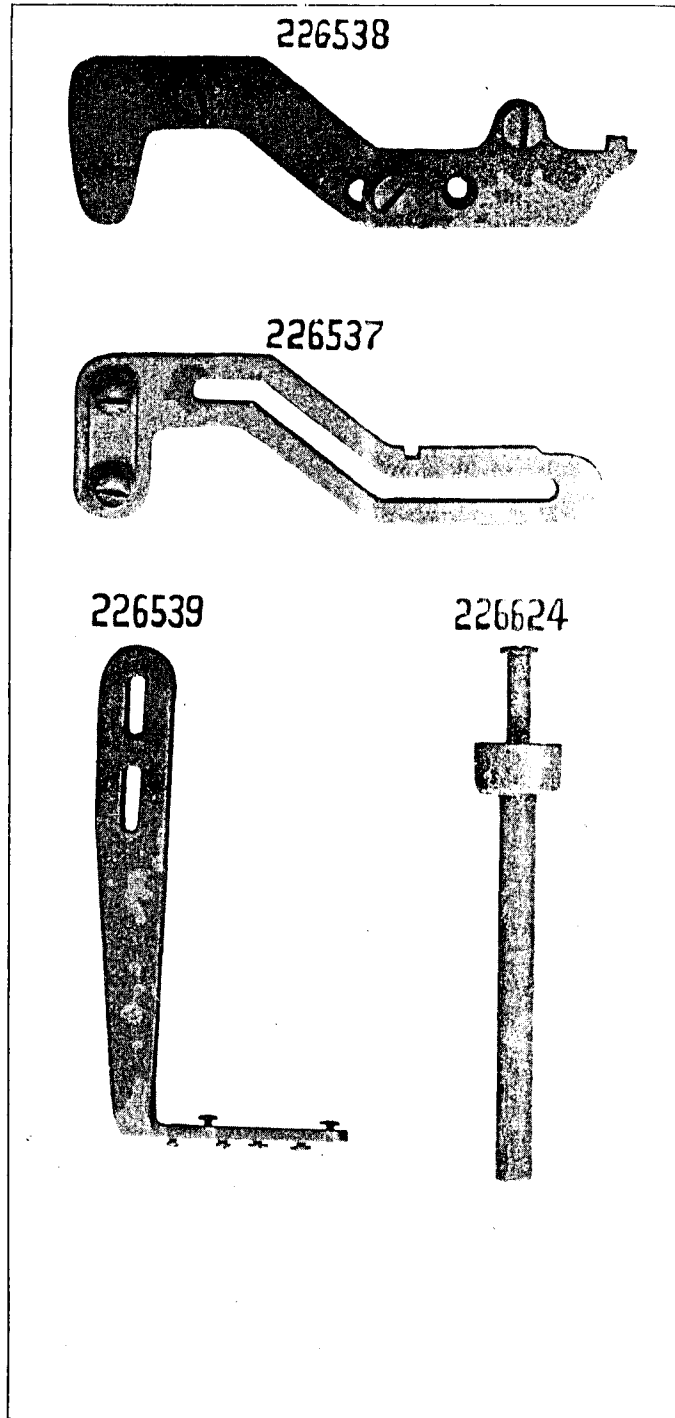
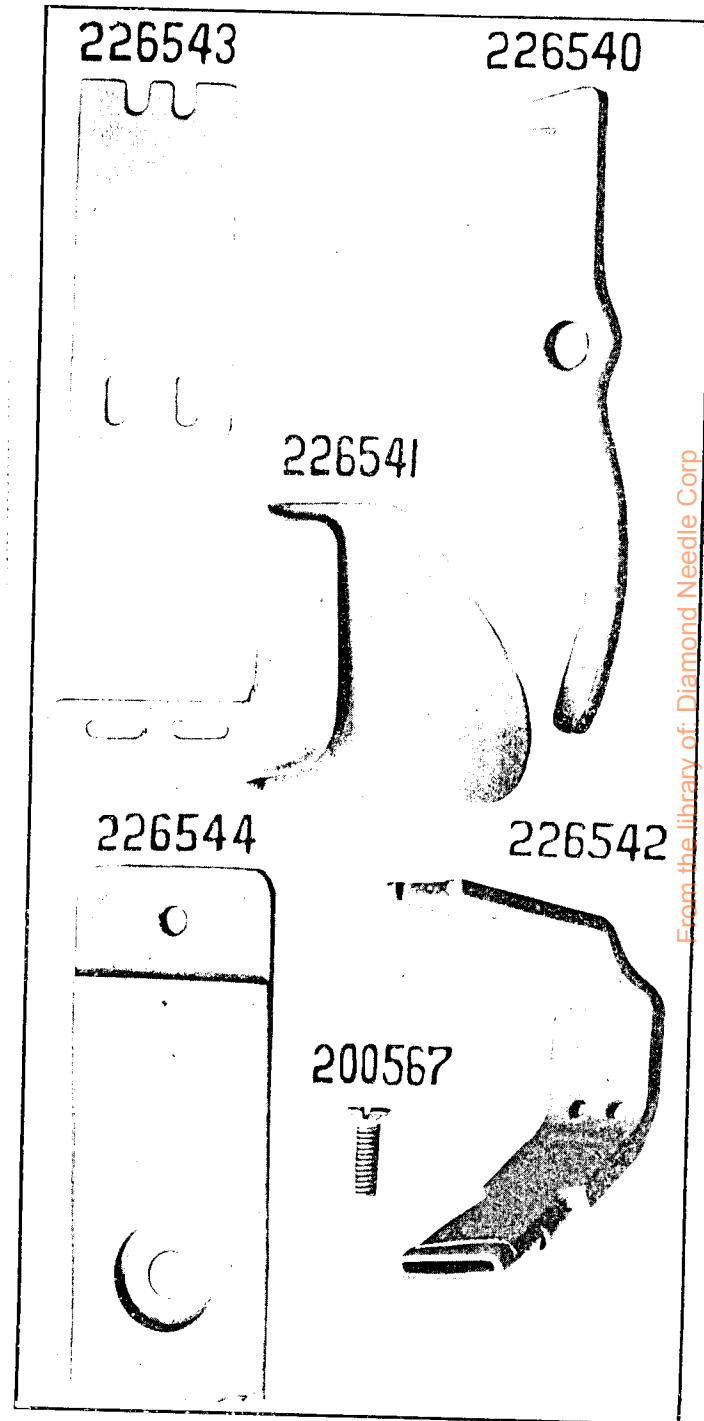
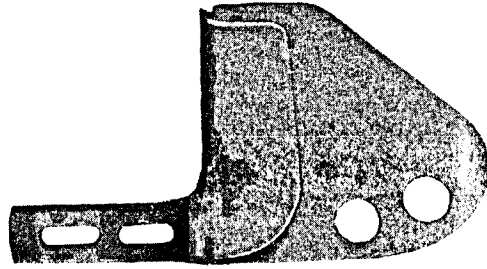


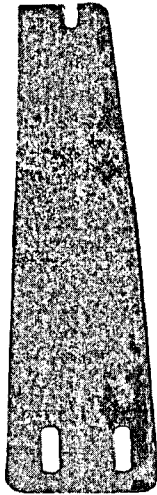
PLATE 11507—FULL SIZE



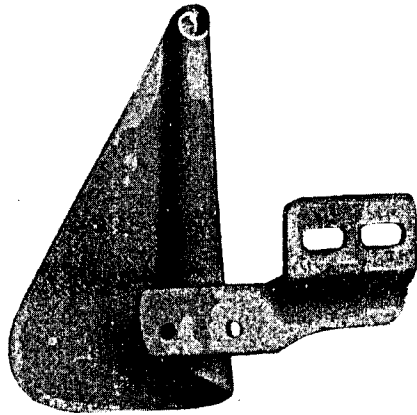
226549



226550



226548



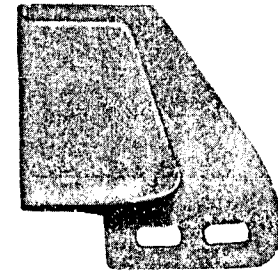
226547



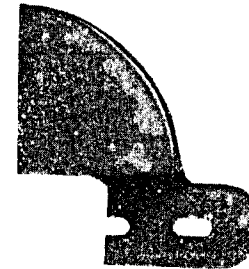
226552



226553



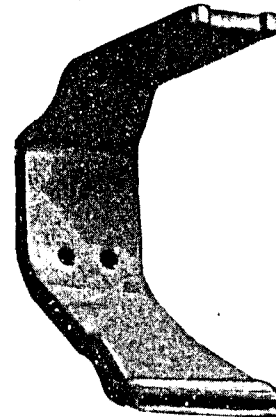
226554



226556



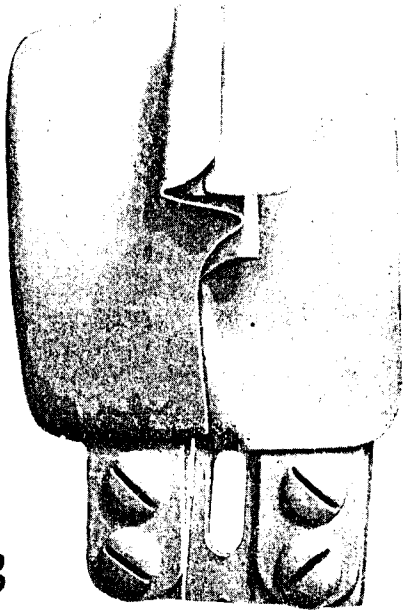
226555



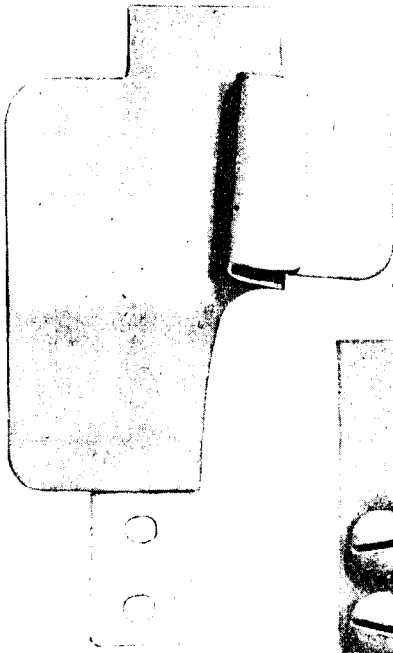
From the library of: Diamond Needle Corp

226322

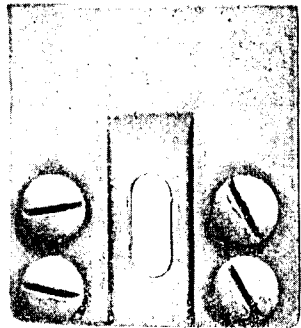
226325



226323

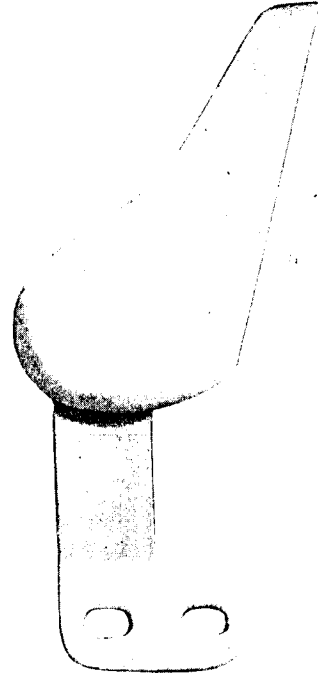
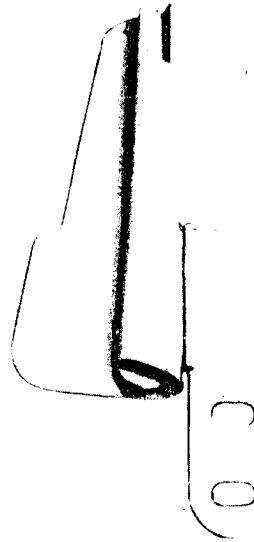


226324



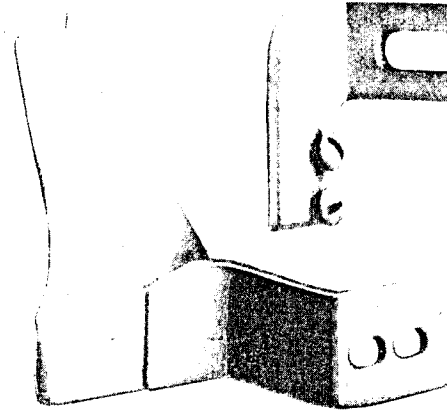
226559

226560



226561

226563



226566



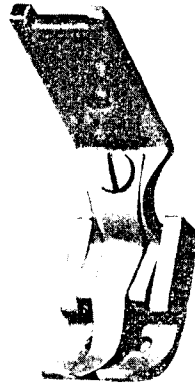
200566



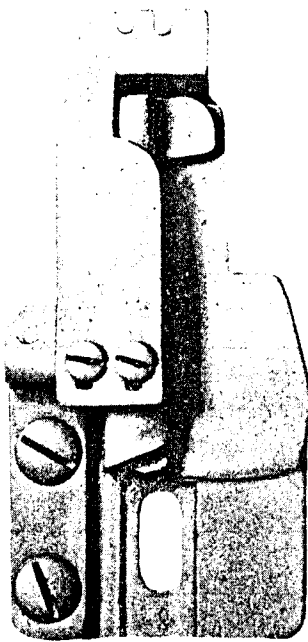
226568



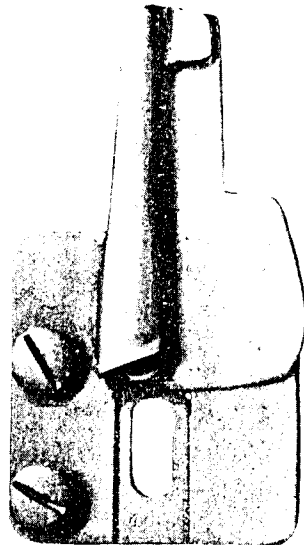
226567



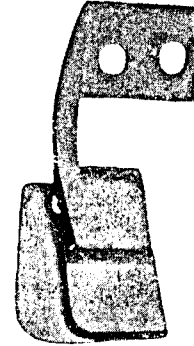
226571



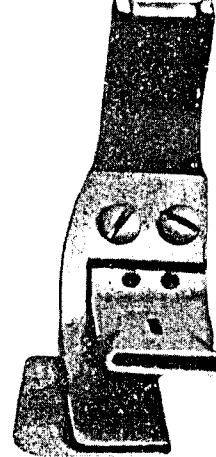
226570



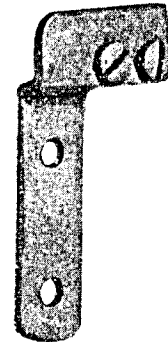
226572



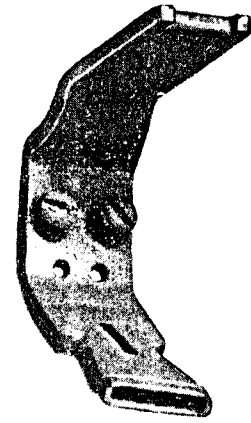
226574



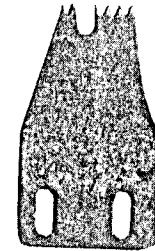
226577



226573



226575

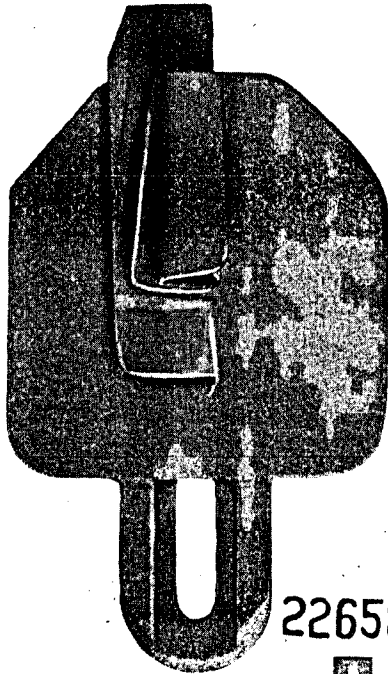


226576

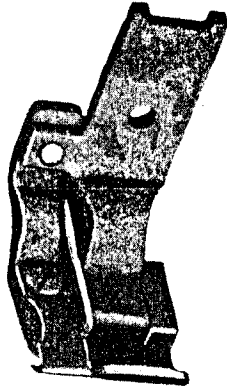


From the library of: Diamond Needle Corp

226579



226580



226581



226582



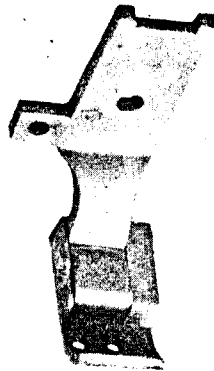
200170



226586



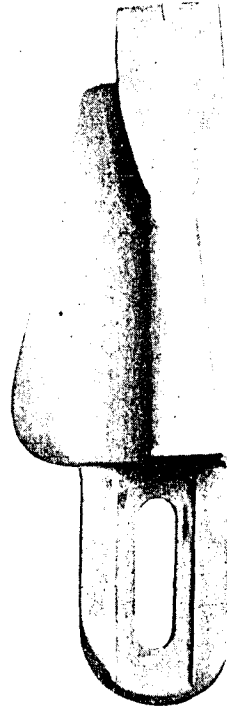
226585



200483



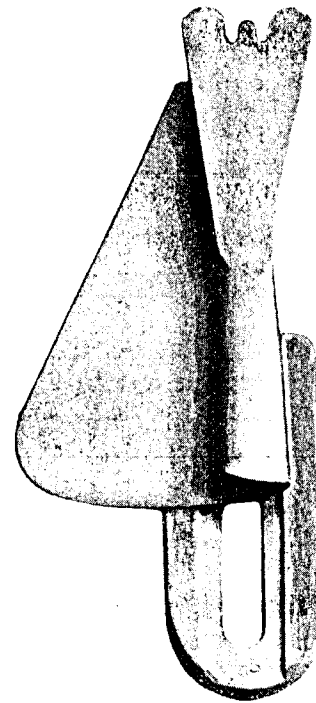
226588



226595



226593



226608



PLATE 11516--ONE-HALF SIZE

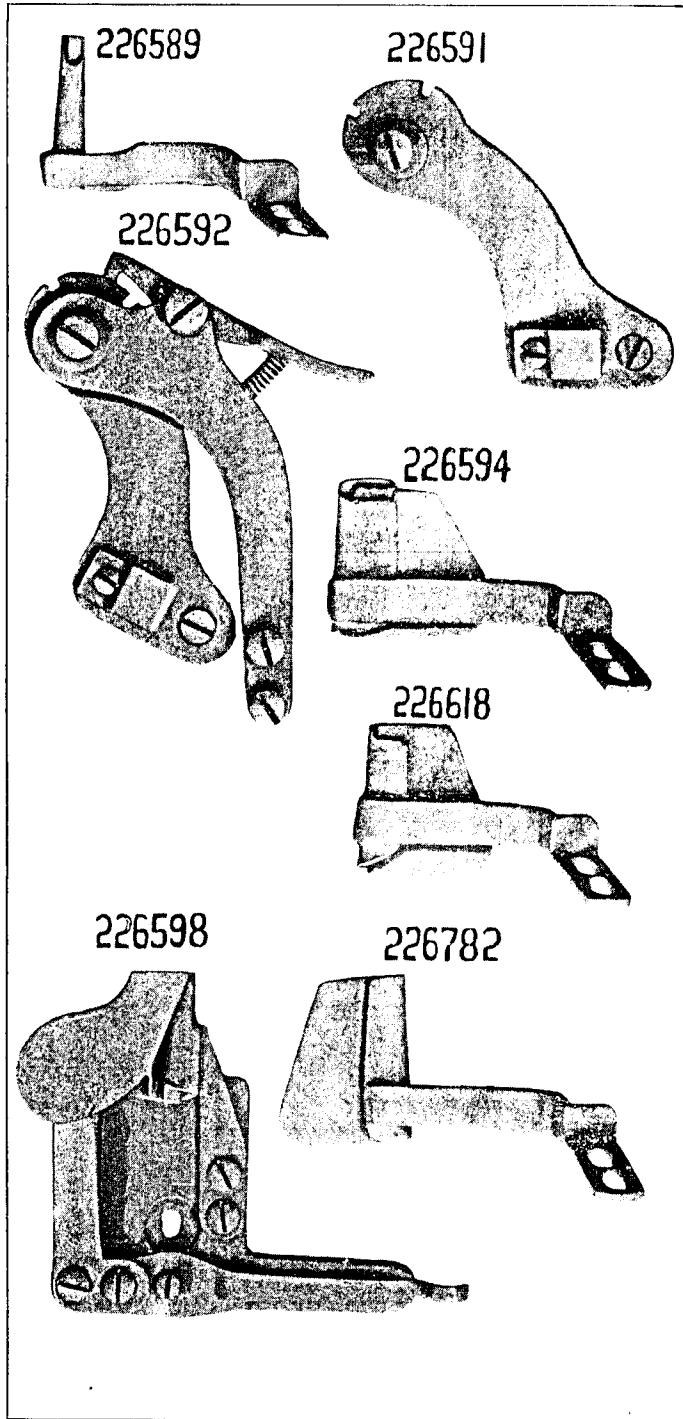


PLATE 11517--FULL SIZE

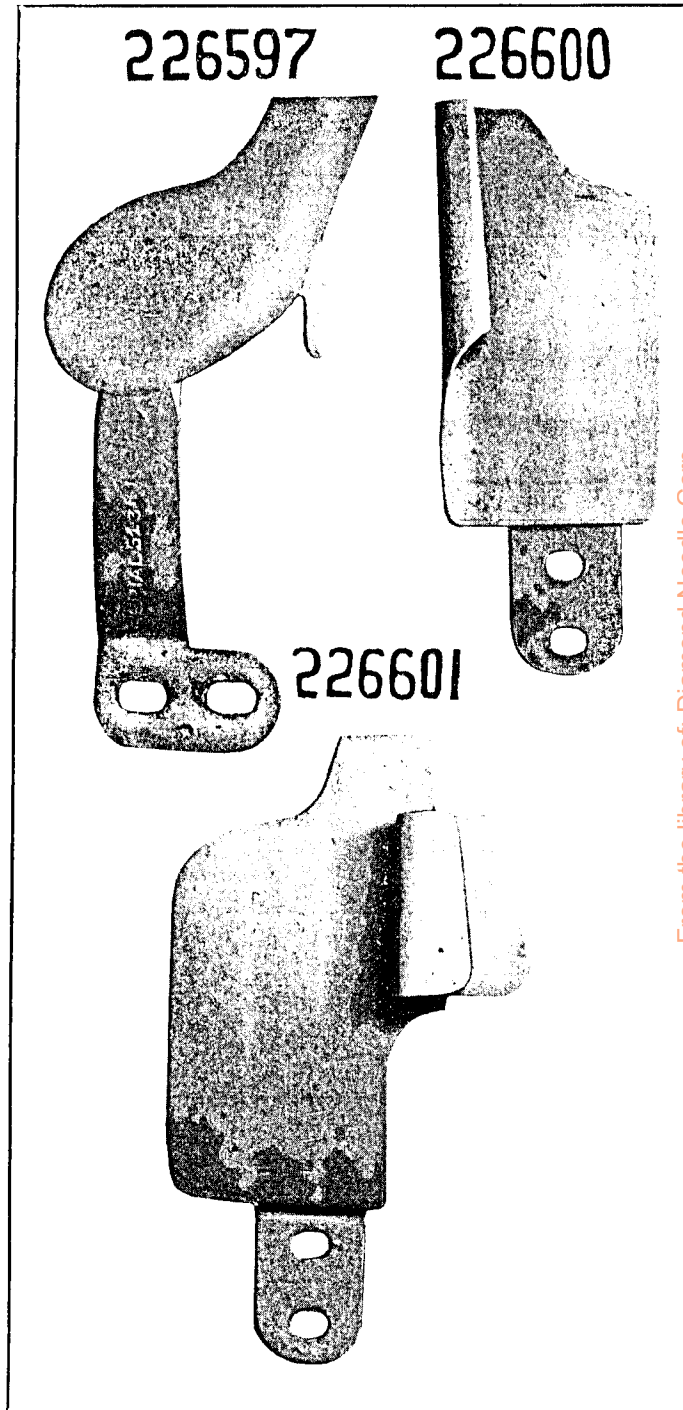
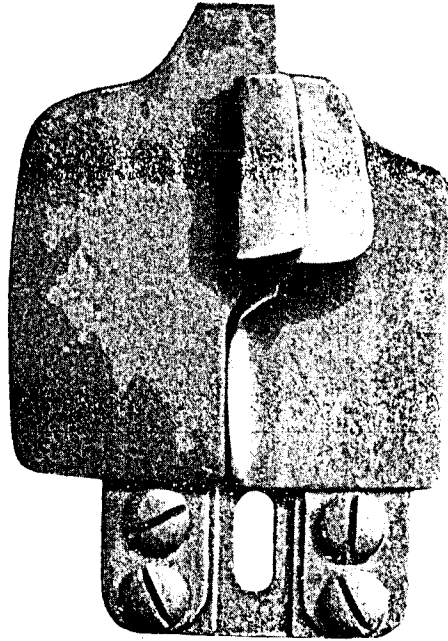
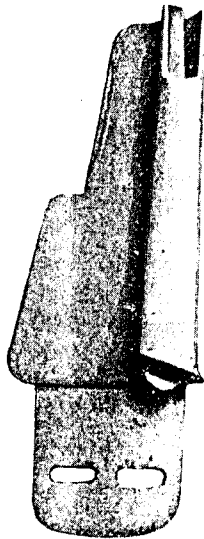


PLATE 11518—FULL SIZE

226602



226604



226605

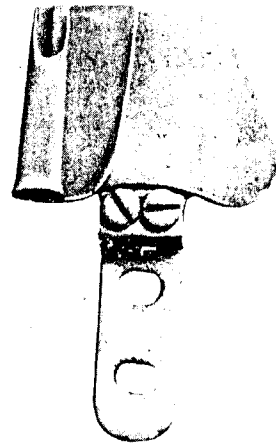
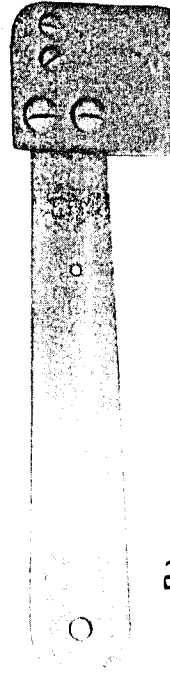
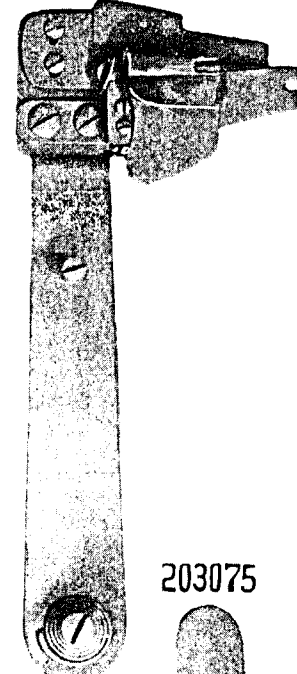


PLATE 11519—ONE-HALF SIZE

226606



226607



226664



203075



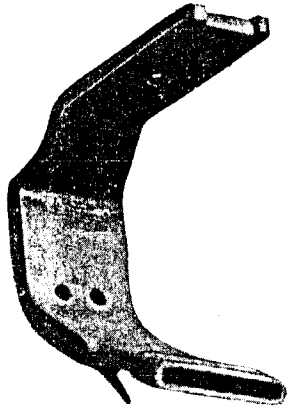
226617



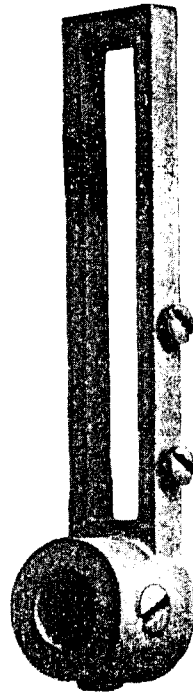
From the library of: Diamond Needle Corp

PLATE 11520—FULL SIZE

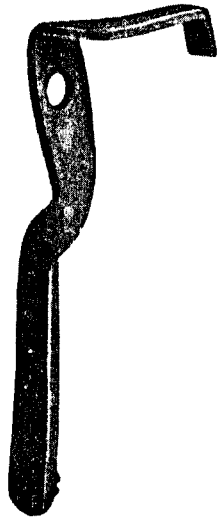
226609



226610



226611



226612



226613

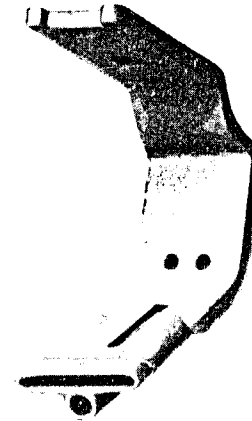


PLATE 11521—FULL SIZE

226614



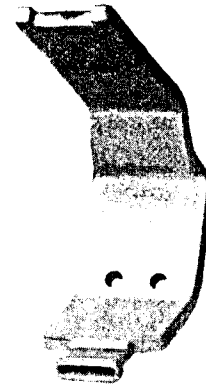
226619



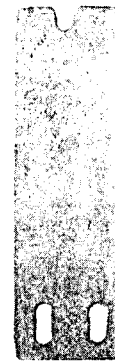
226621



226622



226629



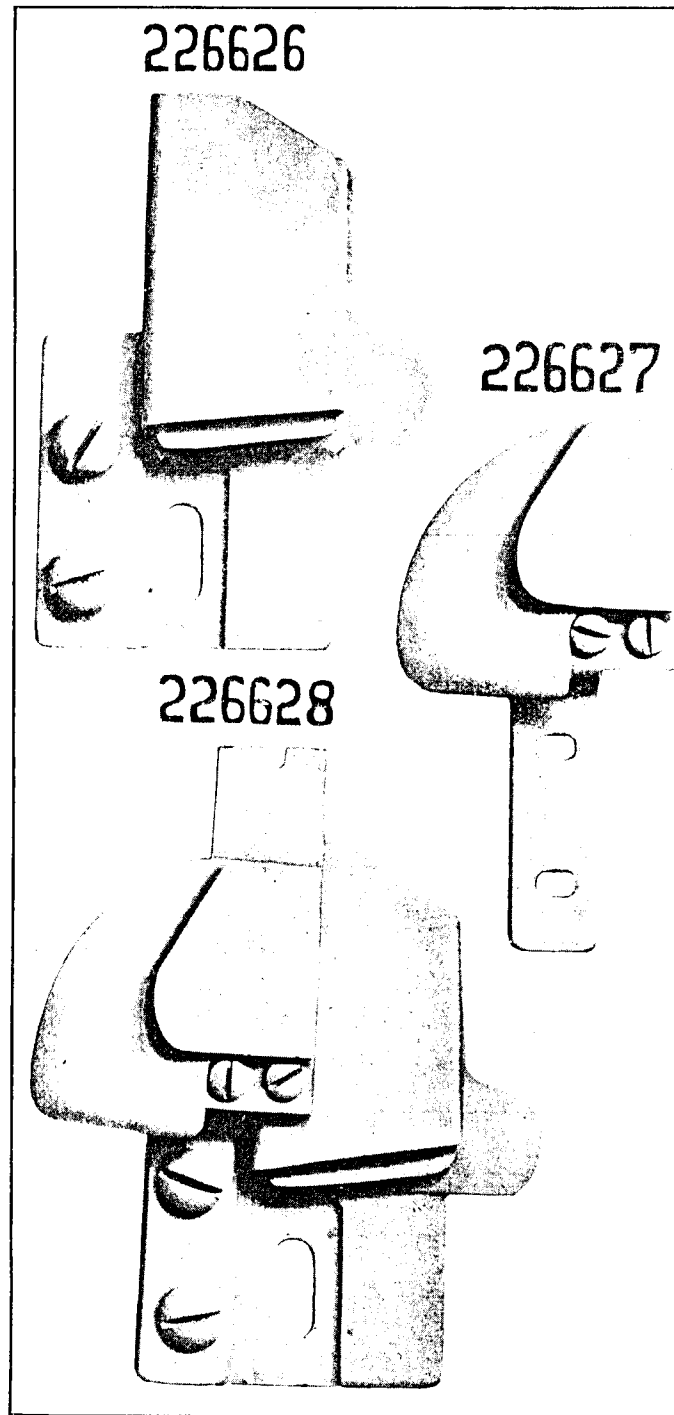
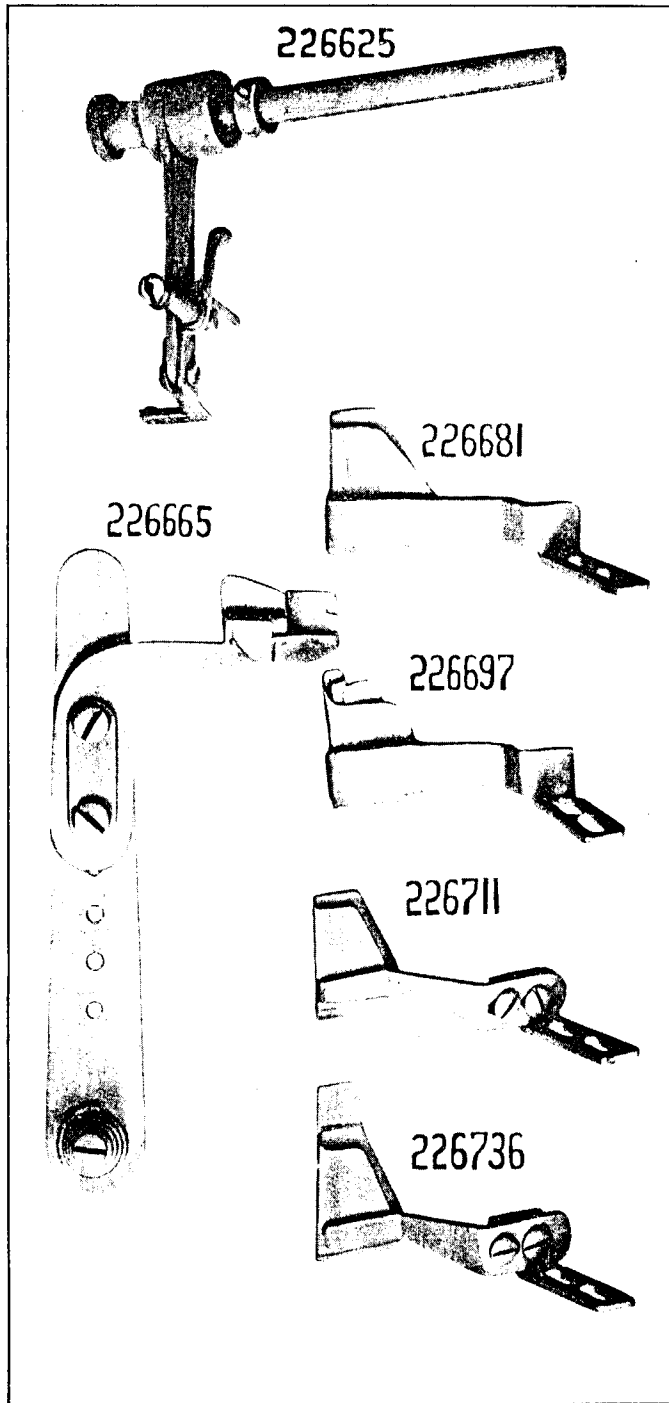
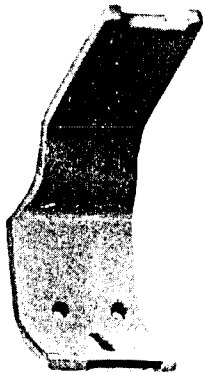
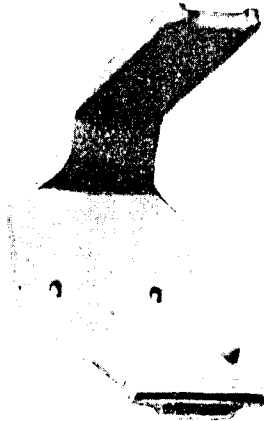


PLATE 11524-FULL SIZE

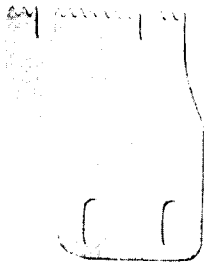
226630



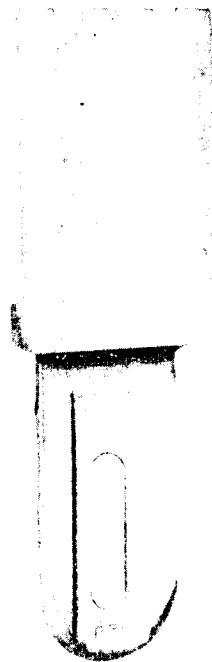
226633



226634



226635



226659

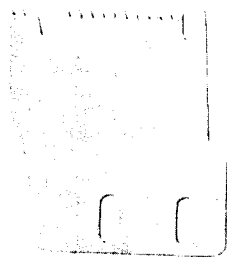
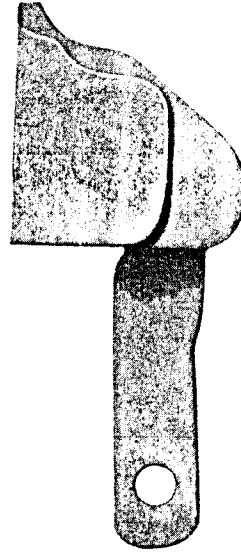


PLATE 11525-FULL SIZE

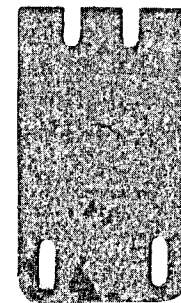
226637



226638



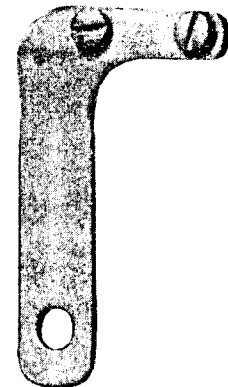
226640



226639

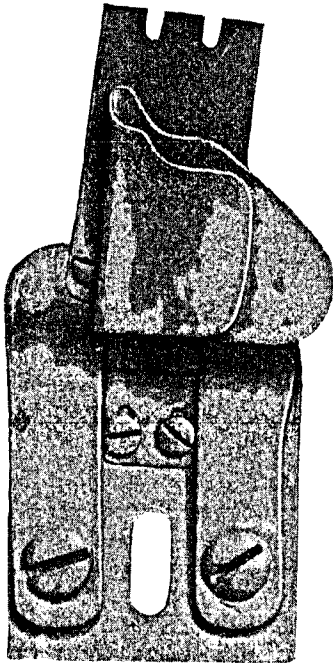


226641

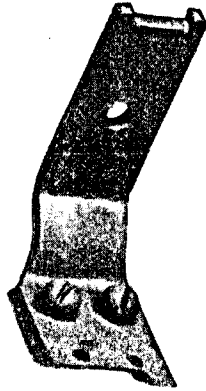


From the library of: Diamond Needle Corp

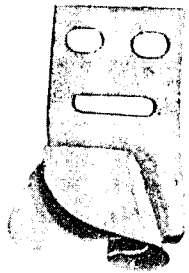
226642



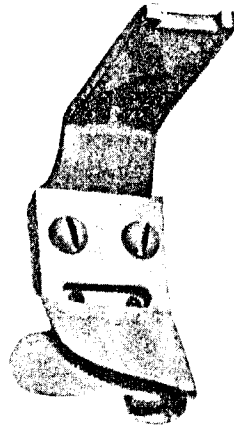
226643



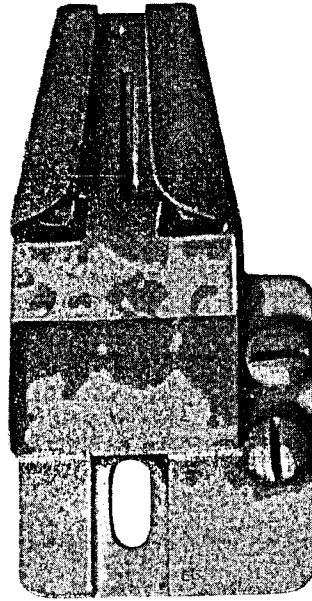
226644



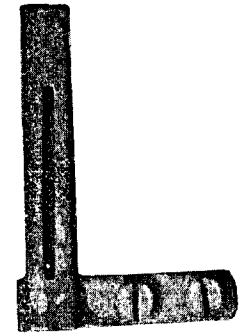
226645



226647



226648



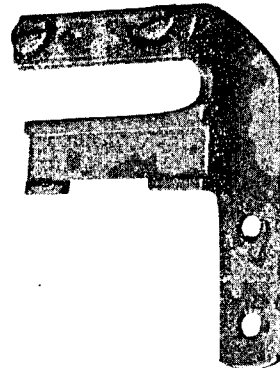
226649



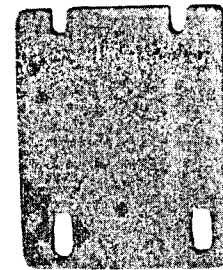
226650



226652

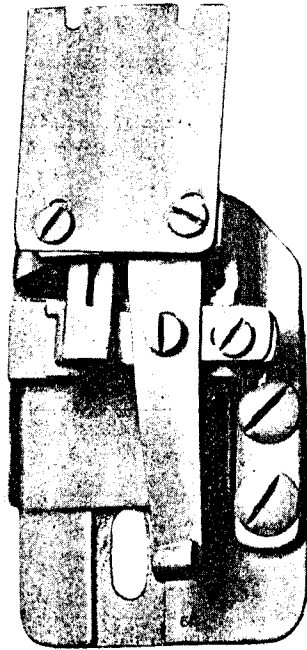


226651



From the library of: Diamond Needle Corp

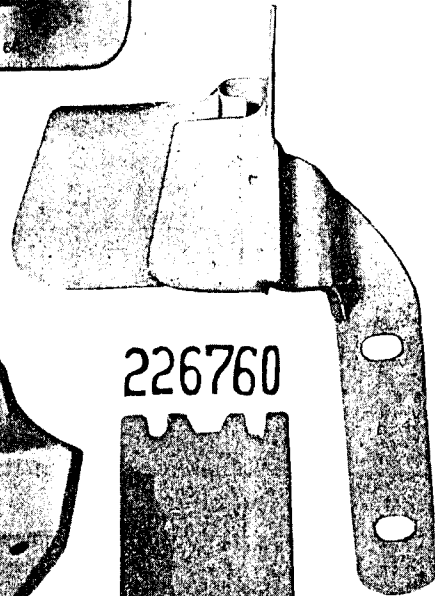
226653



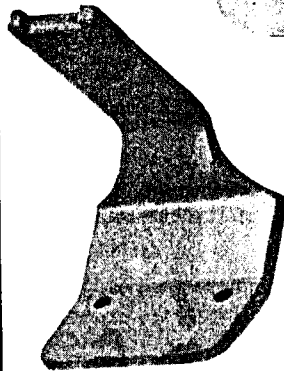
226654



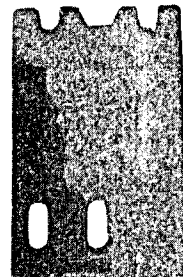
226657



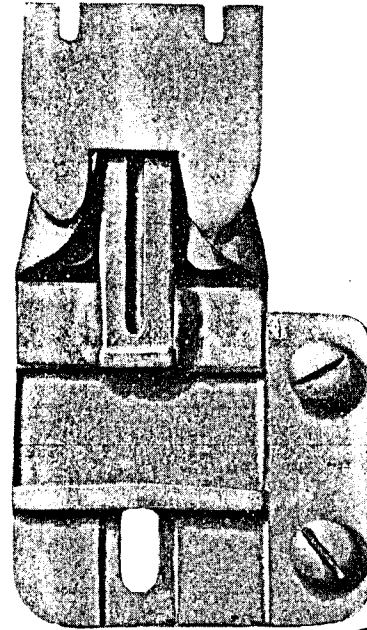
226660



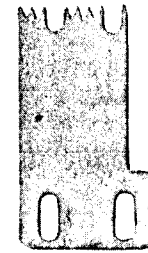
226760



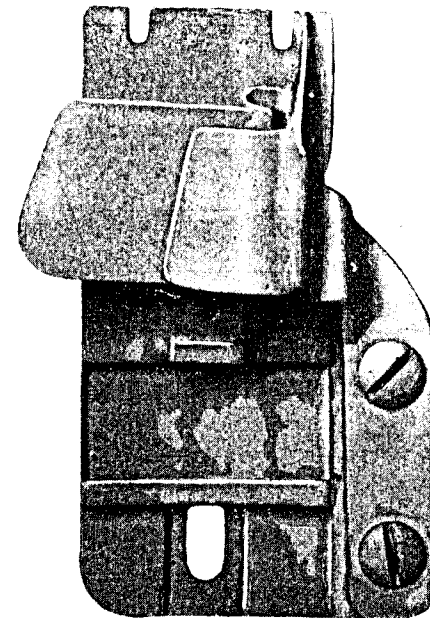
226656



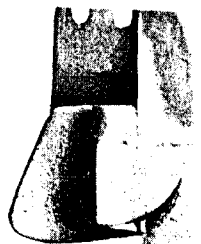
226686



226658



226662



226663



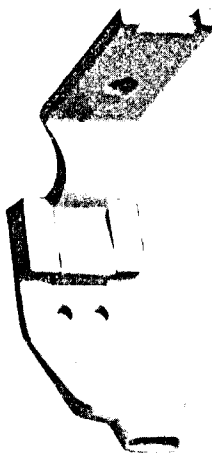
226666



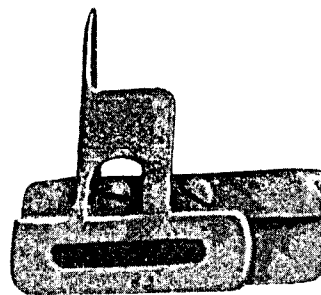
226667



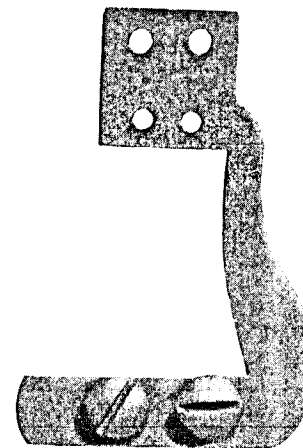
226669



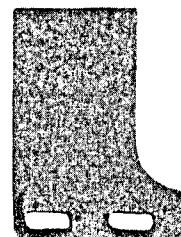
226671



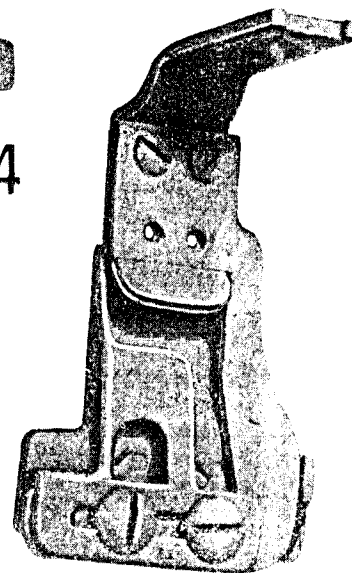
226672



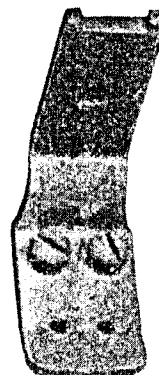
226673



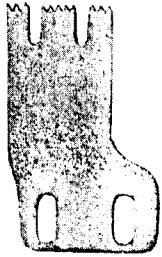
226675



226674



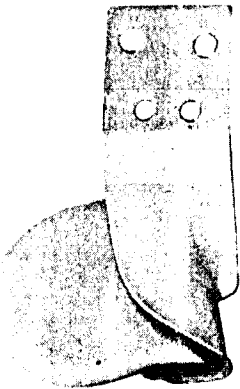
226676



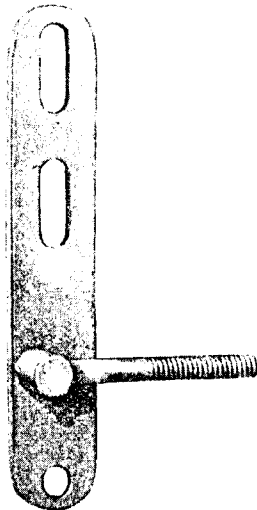
226678



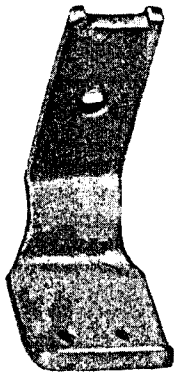
226679



226687



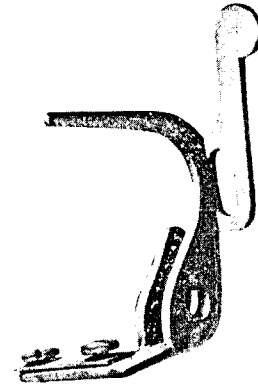
226724



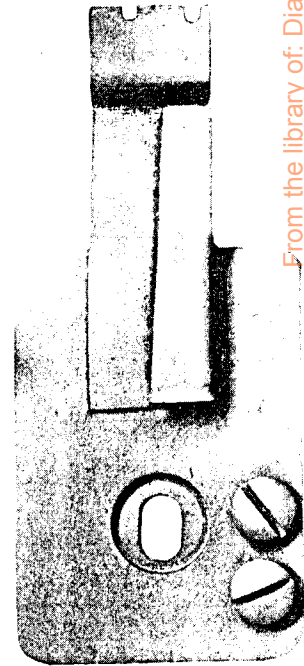
226680



226683



226684



226685

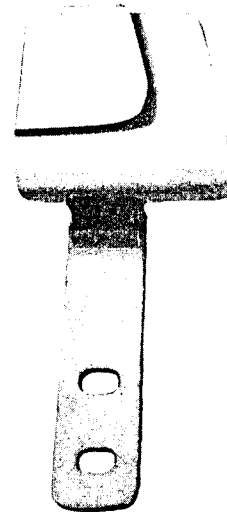
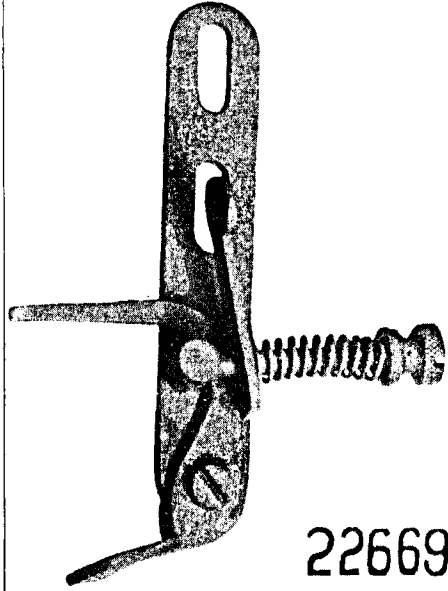


PLATE 11534-FULL SIZE

226688



226694



226695



226690

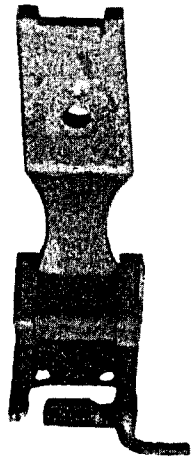
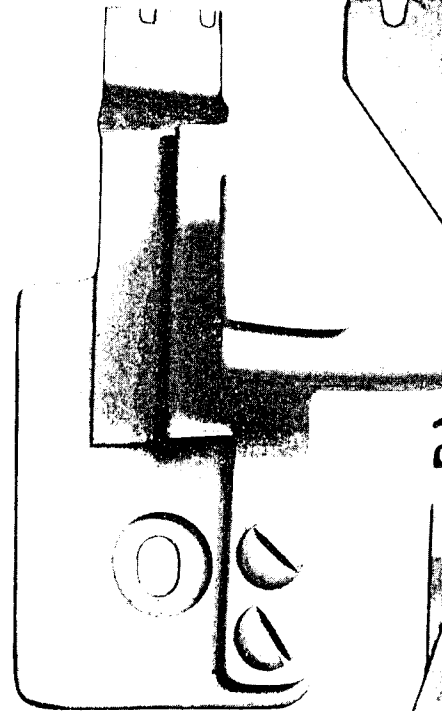


PLATE 11535-FULL SIZE

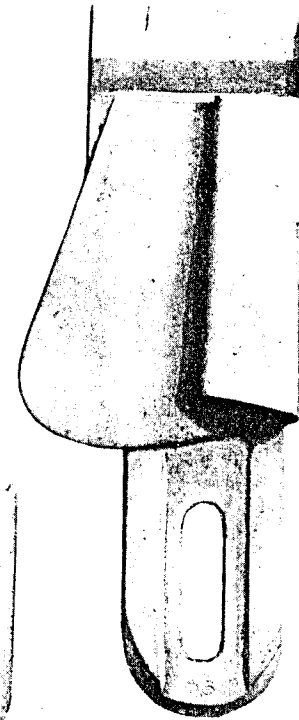
226691



226700



226699



226715

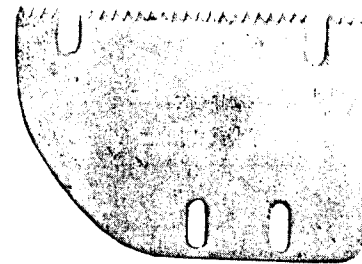
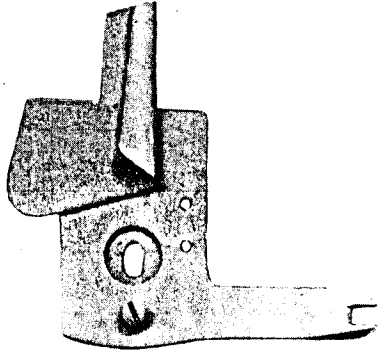
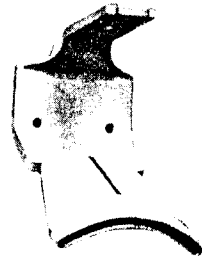


PLATE 11536—ONE-HALF SIZE

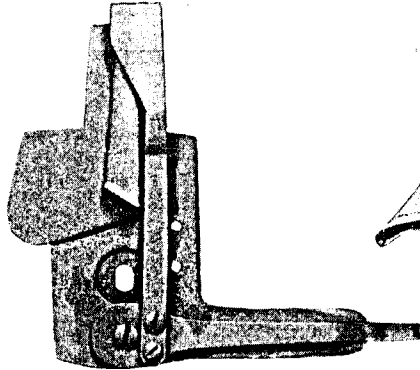
226693



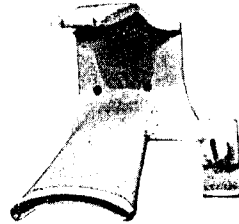
226701



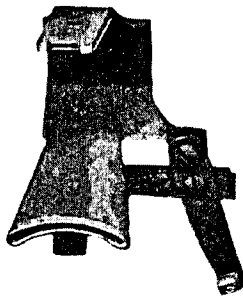
226696



226729



226733



226779

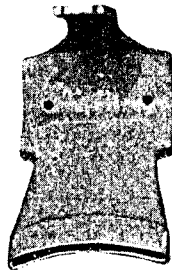
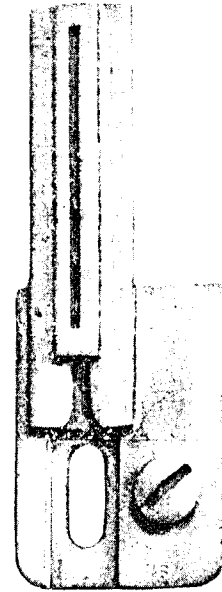
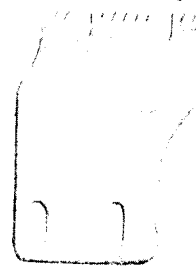


PLATE 11537—FULL SIZE

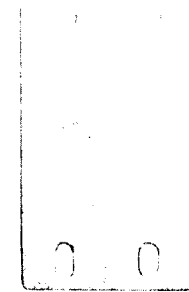
226703



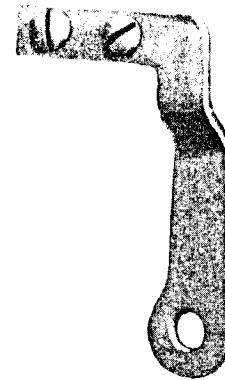
226704



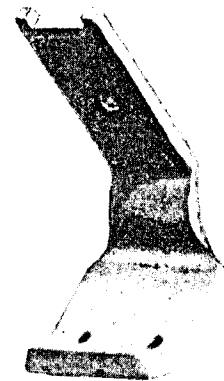
226705



226706



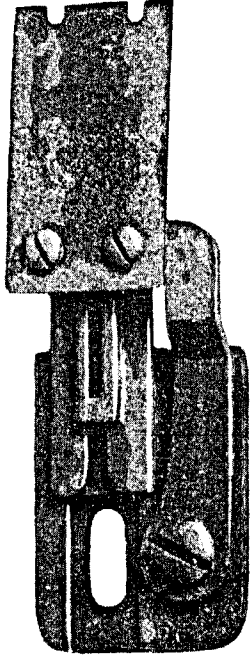
226708



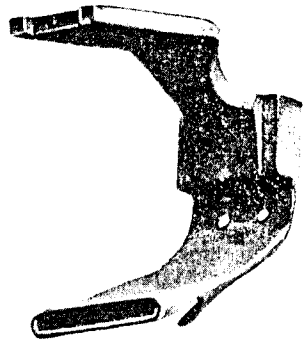
From the library of: Diamond Needle Corp

PLATE 11538—FULL SIZE

226707



226713



226710

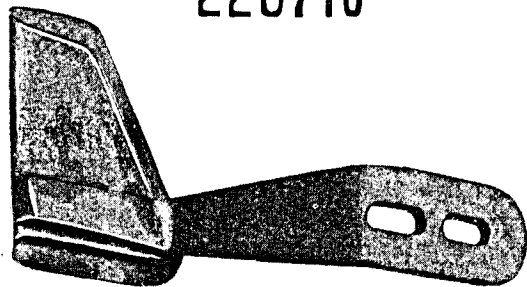
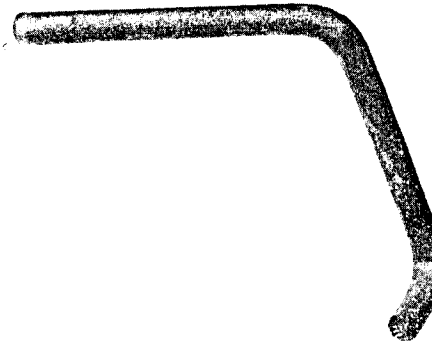
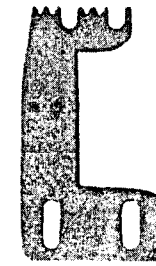


PLATE 11539—FULL SIZE

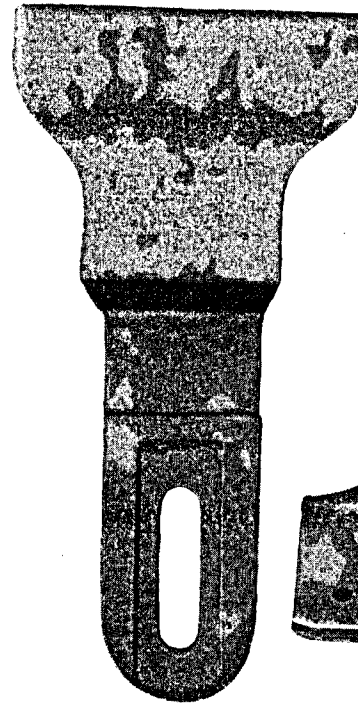
226716



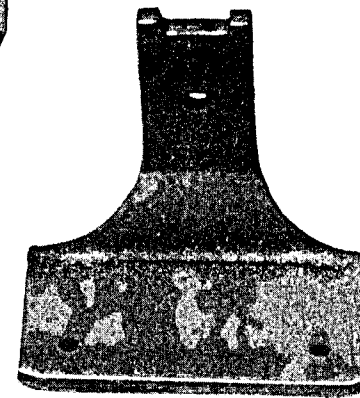
226743



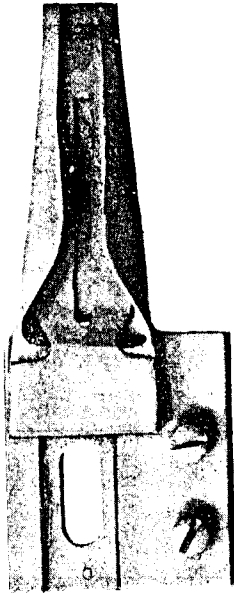
226717



226718

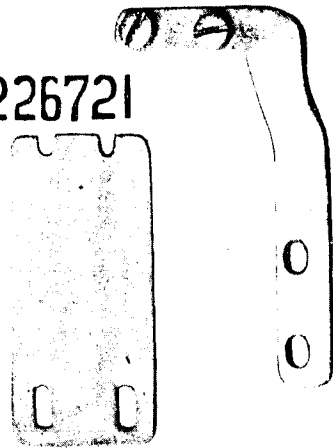


226720

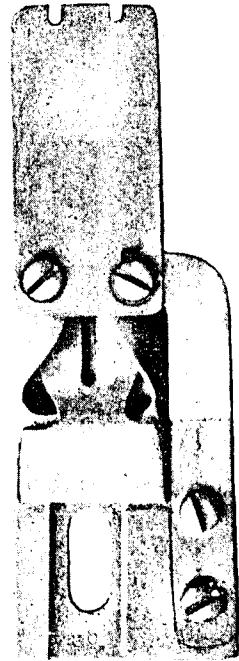


226722

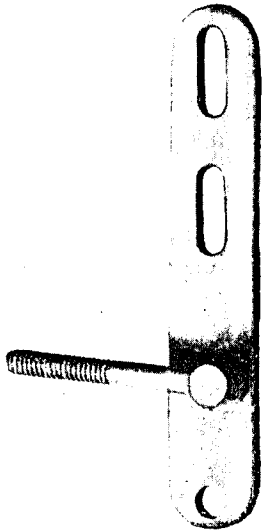
226721



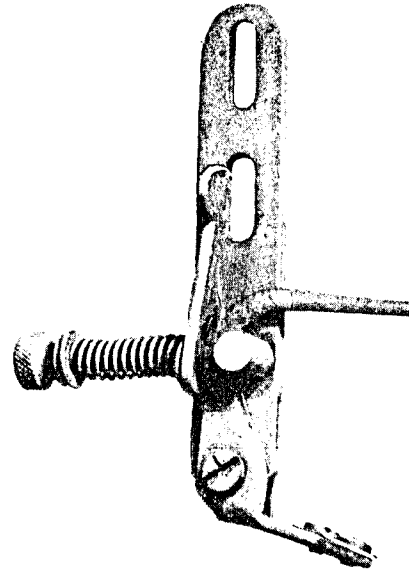
226723



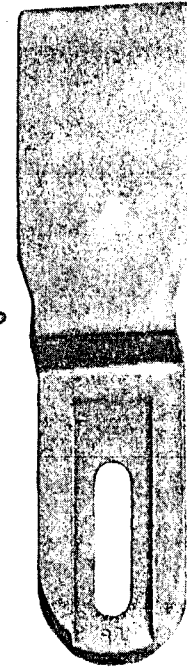
226726



226727



226728



226730



226731



226732



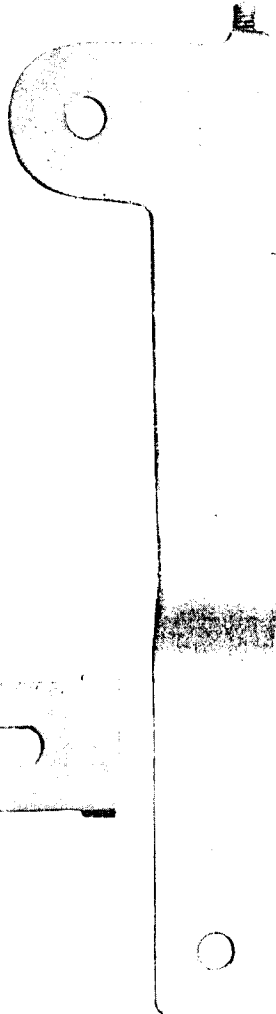
200924



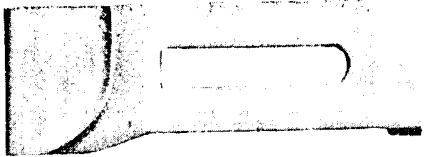
PLATE 11542—FULL SIZE

226747

226738



226740



226735

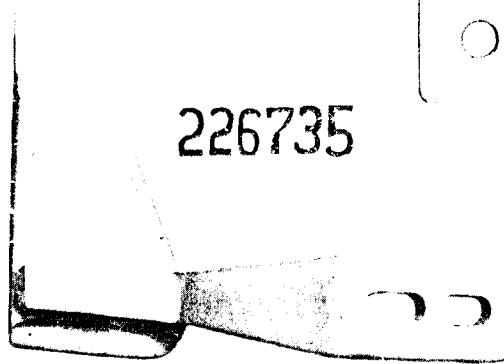
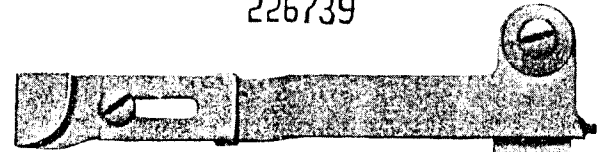


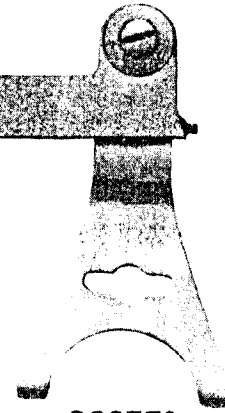
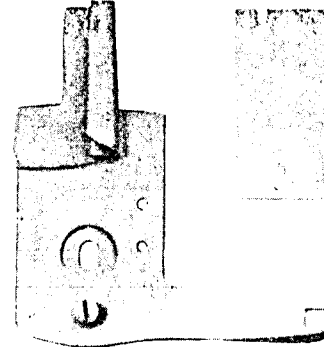
PLATE 11543—ONE-HALF SIZE

226739



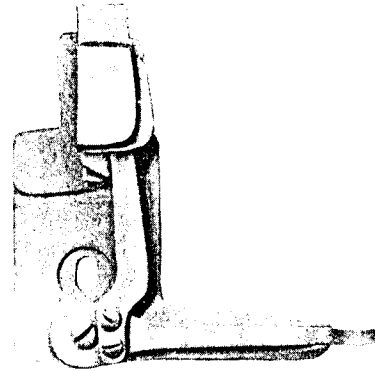
226766

226775



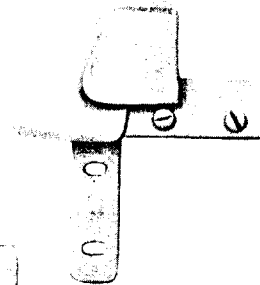
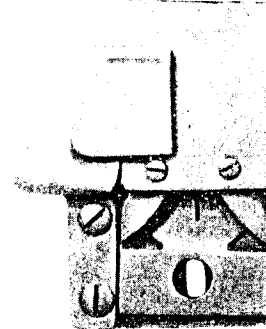
226773

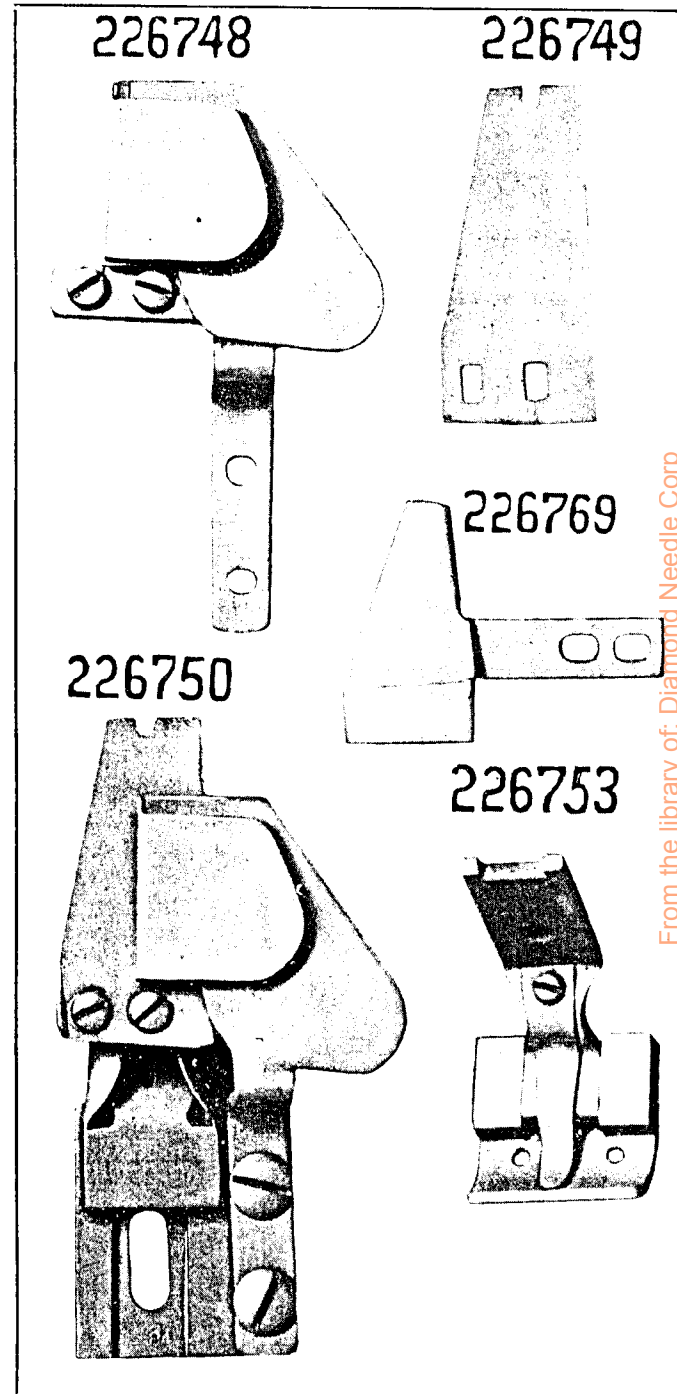
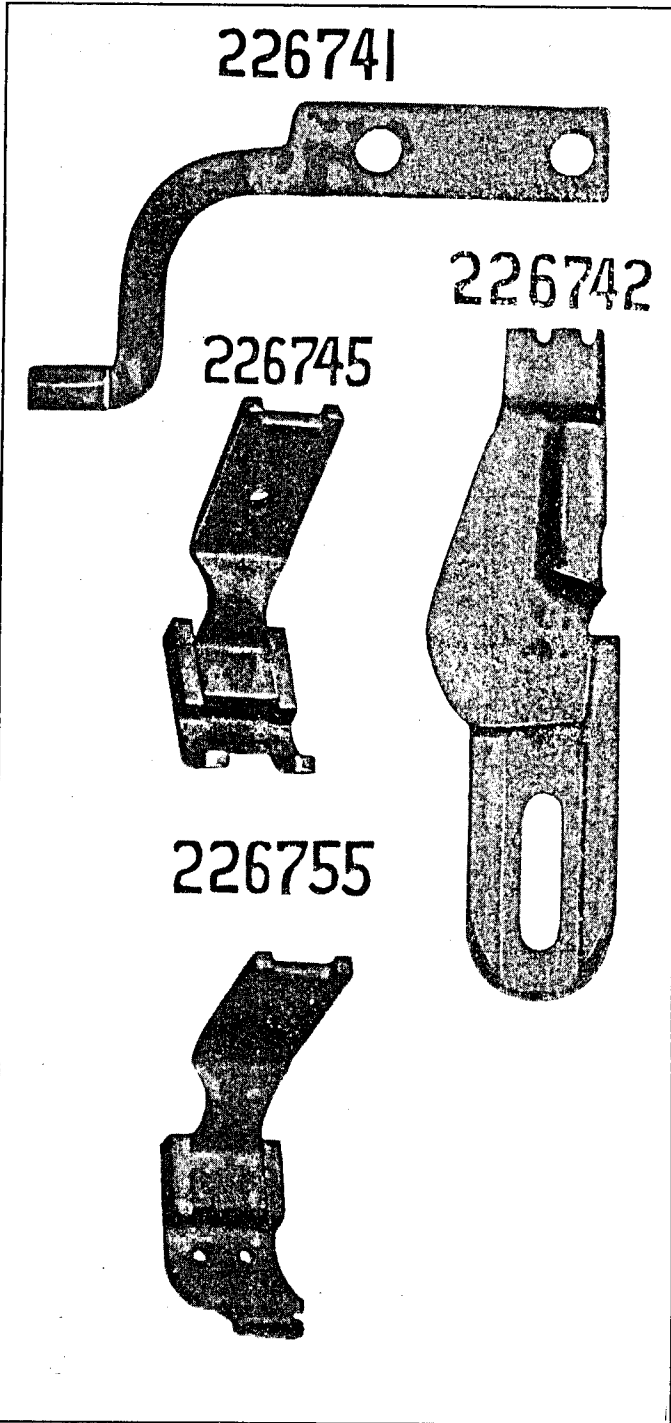
226768



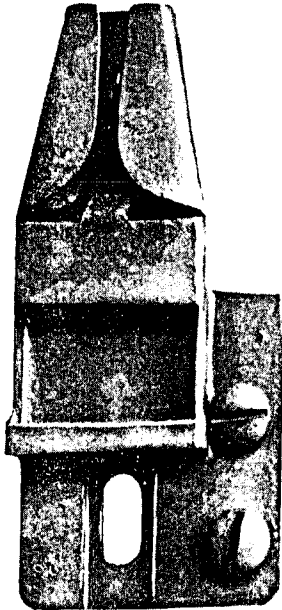
226774

226776

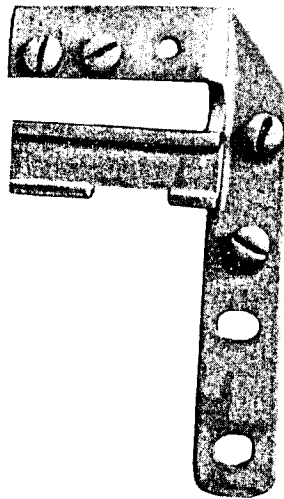




226757



226761



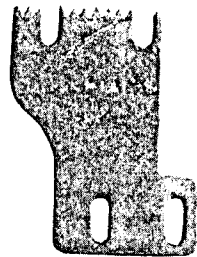
226758



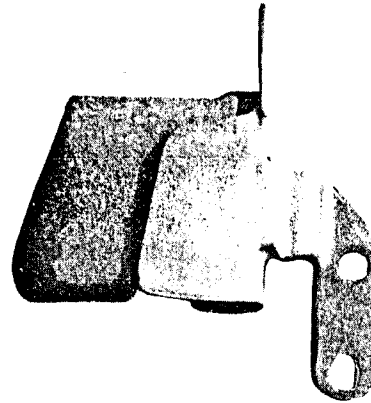
226759



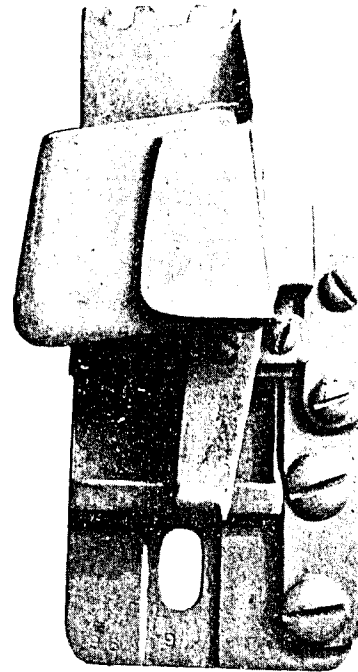
226764



226762



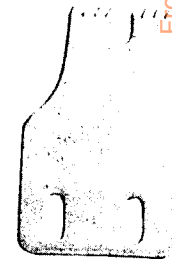
226763



226767



226777

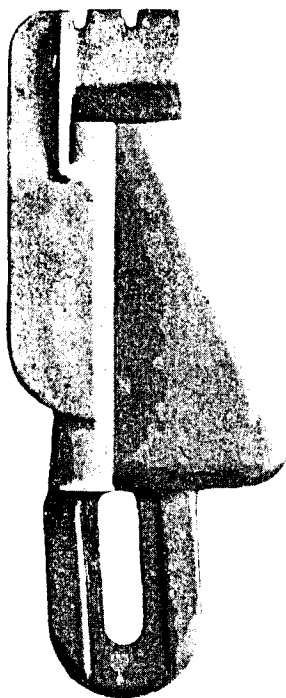


From the library of: Diamond Needle Corp

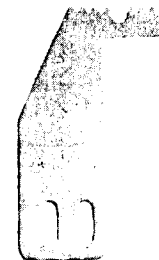
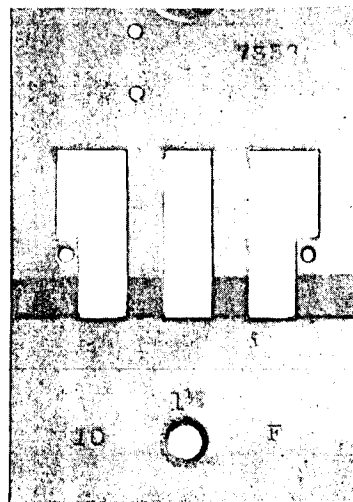
226770 226771 226778



226781



211894 226786
211895



226787

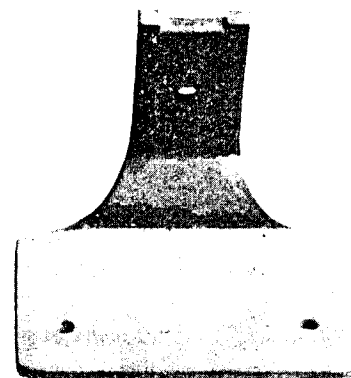


PLATE 13084— FULL SIZE

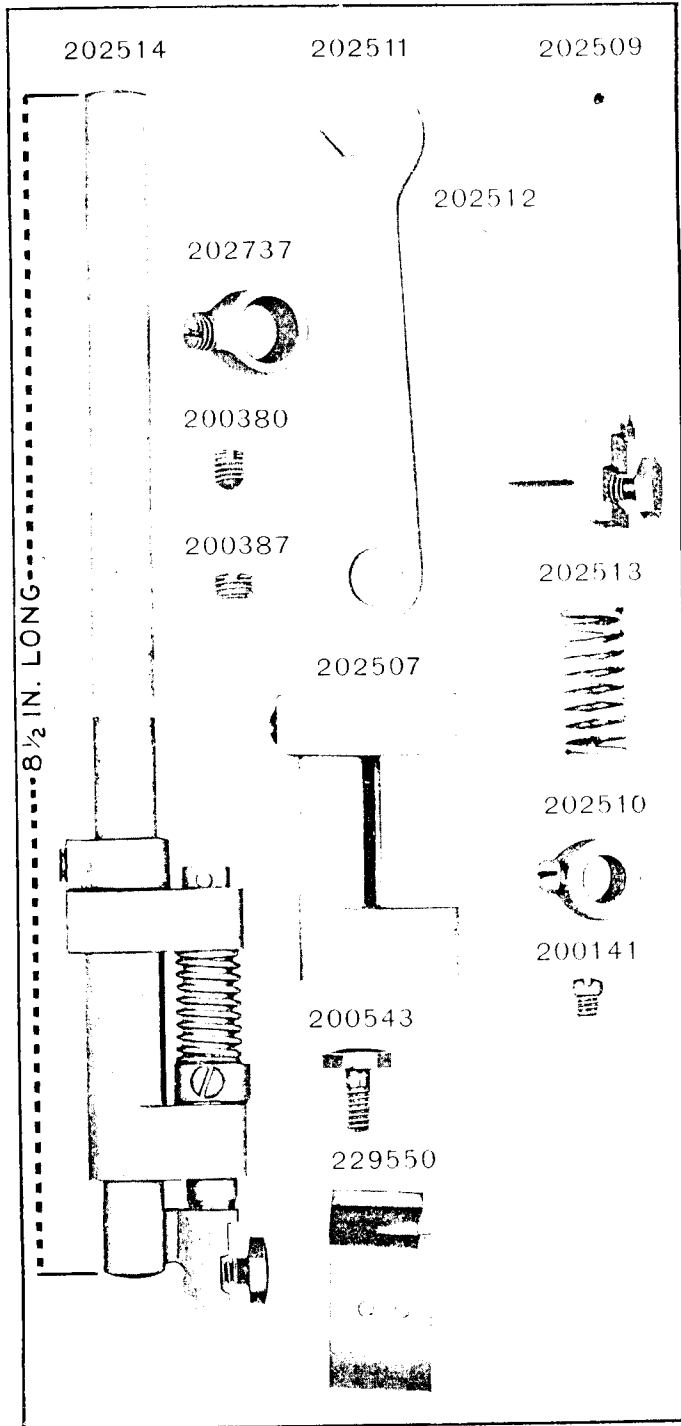


PLATE 14501—FULL SIZE

